

XG-MB65X-L

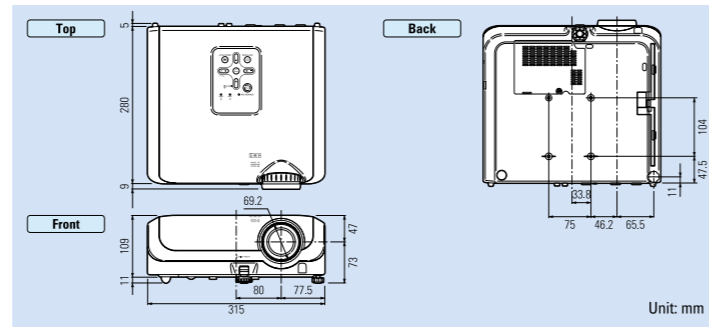



XG-MB55X-L



Dimensions (XG-MB65X-L/55X-L)

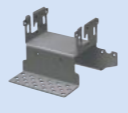

Optional Accessories

Lamp	USB Remote Receiver	Cable	Ceiling Mounts		
 AN-XR20L2	 AN-MR2	 AN-C3CP2 3-RCA to 15-pin D-sub cable (3 m)	 AN-TK201 For high ceiling installation	 AN-TK202 For standard ceiling installation	 AN-60TK Installation adaptor

Note: Some of the optional accessories may not be available depending on the region. Please check with your nearest Sharp Authorized Projector Dealer or Service Center.

Specifications

Model	XG-MB65X-L	XG-MB55X-L
Panels	0.55" DLP® chip	
Number of pixels	786,432 dots (1,024 x 768)	
Resolution	600 TV lines (DTV 720P)	
RGB input signals	SXGA+/SXGA/Mac 21" (in intelligent compression), XGA, SVGA, VGA, PC-98, VESA, Mac 19"167/13"	
Video colour systems	15-70 kHz (horizontal), 45-85 Hz (vertical), 12-108 MHz (pixel clock) (plug & play VESA: DDC 1/2B) NTSC 3.58/NTSC 4.43/PAL/PAL (60Hz)/PAL-M/PAL-N/SECAM DTV (480i/480P/540P/576i/576P/720P/1035i/1080i-50Hz/60 Hz)	
Lens	1:1.15 manual zoom and focus	
Projection size	40" (102 cm) to 300" (762 cm) diagonal [Normal Mode (4:3)]	
Projection distance	40" (102 cm): 1.4 – 1.6 m, 100" (254 cm): 3.5 – 4.0 m, 300" (762 cm): 10.4 – 12.1 m	
Luminance	3,000 ANSI lumen (Standard Mode) 2,400 ANSI lumen (Low Power Mode)	2,500 ANSI lumen (Standard Mode) 2,000 ANSI lumen (Low Power Mode)
Contrast ratio	2000:1	
Audio amplifiers	2W (mono)	
Speakers	4 x 2.85 cm (oval) x 1	
Input terminals	Computer RGB/component x 2 (15-pin mini D-sub), video x 1 (RCA), S-video x 1, audio x 2 (3.5 mm mini jack x 1 / RCA L/R), RS-232C serial x 1 (9-pin mini DIN)	
Output terminals	Computer RGB/component x 1 (15-pin mini D-sub), audio x 1 (3.5 mm stereo mini jack)	
Power source	AC 100-240V, 50/60 Hz (Multi-Voltage)	
Power consumption	350W (Standard Mode), 280W (Low Power Mode), 4.7W (Standby) with AC 100V 330W (Standard Mode), 270W (Low Power Mode), 6.1W (Standby) with AC 240V	
Heat dissipation	1,315 BTU/hour (Standard Mode)/ 1,050 BTU/hour (Low Power Mode) with AC 100V 1,240 BTU/hour (Standard Mode)/ 1,010 BTU/hour (Low Power Mode) with AC 240V	
Fan noise	35 dB (Standard Mode)/ 30 dB (Low Power Mode)	
Projection lamp	275W	
Lamp life*1	3,000 hours (Low Power Mode)	
Dimensions (W x H x D)	315 x 109 x 280 mm (main body only), 315 x 120 x 294 mm (including adjuster legs and projecting parts)	
Weight	3.9 kg	
Supplied accessories	Remote control, Two R-6 batteries (AA size, UM/SUM-3, HP-7 or similar), RGB cable (3.0 m), Lens cap, Power cord (1.8 m), DIN-D-sub RS-232C adaptor (15 cm), Operation manual	

Design and specifications are current as of December 2006, but are subject to change without notice.

* DLP®, the DLP logo and TrueVision are registered trademarks of Texas Instruments.

* All company and/or product names are trademarks and/or registered trademarks of their respective manufacturers.

Sharp makes no warranties or representations of any kind with respect to these products.

*1 The lamp life may vary depending on the usage condition.

SHARP

XG-MB65X-L/XG-MB55X-L
True XGA Multimedia Projector



Long-Lasting High-Quality Performance from DLP® Technology to Respond to Multiple Needs from Business to Education



SHARP
SHARP CORPORATION OSAKA, JAPAN
URL <http://www.sharp-world.com/>

© SHARP CORP. (DEC. 2006 PRINT) | E



TrueVision™

Simple-to-Use New DLP® Projector with High-Contrast, High-Brightness and High-Quality Performance Reliability to Meet Your Needs

High-Performance Projection Elements

3000 ANSI Lumen (XG-MB65X-L)
2500 ANSI Lumen (XG-MB55X-L)
High Brightness (Standard Mode)

Sharp's advanced optoelectronics technology maximizes light output, providing crystal clear images in amazingly high brightness.

Low Fan Noise

The DLP® high-speed colour wheel with non-contact Fluid Dynamic Bearings together with multiple ultra-quiet cooling fans reduce unpleasant noise, enabling quiet operation at 30dB in Low Power mode. The operation is so quiet it causes no disturbance even in meetings or school classes.

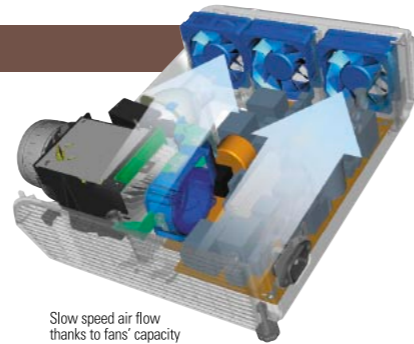

Slow speed air flow thanks to fans' capacity

Cutting Edge Technology Provides High-Quality Picture

2000:1 High-Contrast, High-Quality Image

By utilizing the DLP® optical system and Sharp's optical technology, the projectors produce crisp details and sharper blacks in black parts thanks to a 2000:1 high contrast ratio.

Comparison of Contrast Ratio



XG-MB65X-L/55X-L

Models in the same class as the XG-MB65X-L/55X-L generally provide a contrast ratio of 400:1.

IP Conversion from TrueVision™ Image Processing

TrueVision™ Image Processing provides optimal video performance. The motion-adaptive scan images produce smooth moving scenes and ensure smooth natural lines and edges.



DLP® Digital Image

Using DLP chip, each pixel is individually composed of one of over a half a million micromirrors to produce a high resolution, and the micromirrors lie at a distance of merely one micron, providing a seamless finely detailed picture. Also, high-speed on/off switching delivers smooth moving scenes.

High-Resolution Seamless Image Comparison

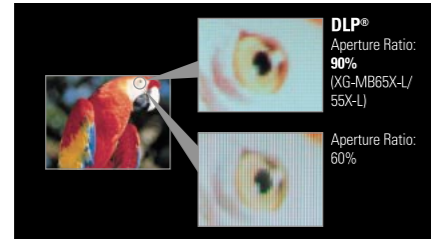

DLP® Aperture Ratio: 90% (XG-MB65X-L/55X-L)

Aperture Ratio: 60%

3X Speed Colour Wheel

The projectors employ a colour wheel with a 3x speed engine, improving colour break-up to an invisible level. Also, the non-contact Fluid Dynamic Bearings for the high-speed rotating colour wheel axle have a longer lifespan.

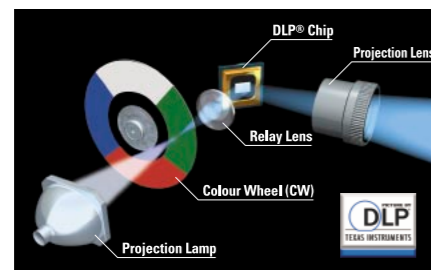

High-Quality Reliability

Long-Life High-Performance DLP® Picture

With DLP® technology minimally absorbing high-output light, the projectors maintain uniform colour reproduction capability for a long period of time. Also, DLP® chip formation with finely structured mirrors provides stable performance and delivers high-quality pictures for longer periods. The DLP® chip in the XG-MB65X-L/55X-L contributes to a long lifespan. In addition, because there is no burn-in or remaining afterimage, the projectors are ideal for still picture projection such as for guidance board applications and projecting CAD images.

DLP® projection

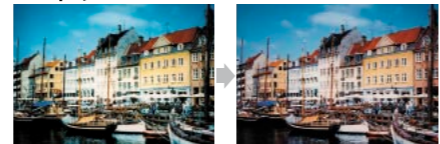

After 4,100 hours (The picture shows no significant deterioration even after using the DLP® chip 4,100 hours.)

* By RIT/Munsell Colour Science Laboratory Test

Double Sealed Mechanism

The optical mechanism is sealed in its structure, preventing dust, dirt and smoke from entering core parts of the optics to a much greater degree. Plus, filters have been added for an enhanced interactive combination to even further block entry of these elements.

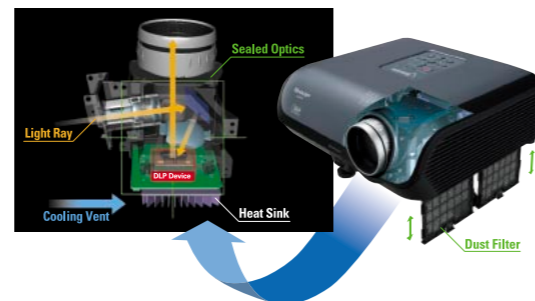

BUSINESS

EDUCATION

Operation Simple Enough for Anyone to Use

Setup Guide for Interactive Operation

The XG-MB65X-L/MB55X-L Setup Guide provides intuitive OSD images to show the next step interactively for setup including focus, zoom and height adjustment.

Setup Guides

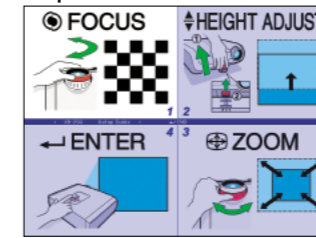

Setup guide is displayed after the projector is turned on.

Interactive Help Menu

The Help Menu displays any problems and assists the user in solving problems with operation.

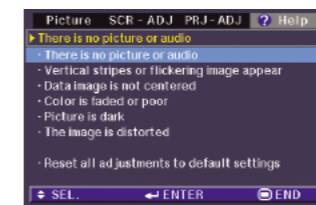

Advanced Picture Mode

Quickly and directly choose the appropriate settings for the picture mode and lamp brightness to match the intended application.

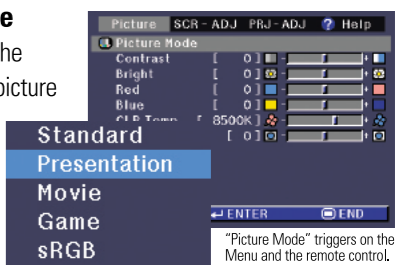

"Picture Mode" triggers on the Menu and the remote control.

Universal Design

The beeping sound informs the user when the power is on and cooling down has completed. Also, intuitive button layout allows the user to operate the projector simply.



Intuitive Button Layout

Quick Start

It takes only approx. 3 seconds to project the image.

Multiple Connections for a Wide Range of Applications

Multiple Input Terminals

Projectors can be connected to DVD players, cable or satellite boxes, laptop and desktop computers, HDTV tuners, VCRs and video game consoles.



Other Outstanding Features

- **4:3 and 16:9 Aspect Ratios and HDTV/DTV and DVD Compatible** (1080i, 1035i, 720P, 576P, 576i, 540P, 480P and 480i).
- **Image Shift Function**
Images projected in 16 x 9 format can be vertically shifted for better viewing in limited spaces.
- **Auto Keystone Correction**
- **Presentation Support: Freeze, AV Mute**
- **Theft Deterrent Function "System Lock"**
- **Key Lock Function**

Correlation of the Projector to the screen

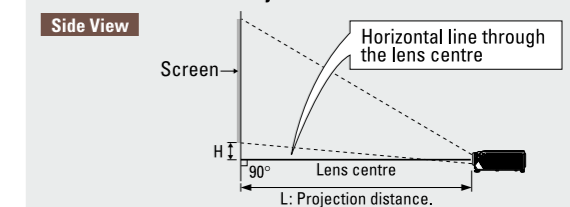

Screen Size and Projection Distance

Picture size			Projection distance [L]		Distance from the bottom of the image to the lens centre [H]
Diag. (inches)	Width (cm)	Height (cm)	Minimum	Maximum	
300	610	457	10.4m	12.1m	48cm
200	406	305	7.0m	8.1m	32cm
100	203	152	3.5m	4.0m	16cm
60	122	91	2.1m	2.4m	10cm
40	81	61	1.4m	1.6m	6cm

STRETCH Mode (16:9)

Picture size			Projection distance [L]		Distance from the bottom of the image to the lens centre [H]	Adjustable range of image position [S]
Diag. (inches)	Width (cm)	Height (cm)	Minimum	Maximum		
250	553	311	9.5m	11.0m	96cm	±52cm
200	443	249	7.6m	8.8m	77cm	±42cm
100	221	125	3.8m	4.4m	38cm	±21cm
60	133	75	2.3m	2.6m	23cm	±12cm
40	89	50	1.5m	1.8m	15cm	±8cm

* Allow a margin of error in the above values.