

# SHARP®

## MULTIMEDIA PROJECTOR

### MODEL

# XR-1S

# OPERATION MANUAL

---



香港電器安全規格  
(國際電工委員會規格適合)

Introduction

Quick Start

Setup

Connections

Basic  
Operation

Useful  
Features

Appendix



## IMPORTANT

For your assistance in reporting the loss or theft of your Projector, please record the Serial Number located on the bottom of the projector and retain this information. Before recycling the packaging, please be sure that you have checked the contents of the carton thoroughly against the list of "Supplied accessories" on page 11.

**Model No.: XR-1S**

**Serial No.:**

### **SPECIAL NOTE FOR USERS IN THE U.K.**

The mains lead of this product is fitted with a non-rewireable (moulded) plug incorporating a 5A fuse. Should the fuse need to be replaced, a BSI or ASTA approved BS 1362 fuse marked  or  and of the same rating as above, which is also indicated on the pin face of the plug, must be used.

Always refit the fuse cover after replacing the fuse. Never use the plug without the fuse cover fitted.

In the unlikely event of the socket outlet in your home not being compatible with the plug supplied, cut off the mains plug and fit an appropriate type.

### **DANGER:**

The fuse from the cut-off plug should be removed and the cut-off plug destroyed immediately and disposed of in a safe manner.

Under no circumstances should the cut-off plug be inserted elsewhere into a 5A socket outlet, as a serious electric shock may occur.

To fit an appropriate plug to the mains lead, follow the instructions below:

### **WARNING:**

THIS APPARATUS MUST BE EARTHED.

### **IMPORTANT:**

The wires in this mains lead are coloured in accordance with the following code:

Green-and-yellow	: Earth
Blue	: Neutral
Brown	: Live

As the colours of the wires in the mains lead of this apparatus may not correspond with the coloured markings identifying the terminals in your plug proceed as follows:

- The wire which is coloured green-and-yellow must be connected to the terminal in the plug which is marked by the letter E or by the safety earth symbol  or coloured green or green-and-yellow.
- The wire which is coloured blue must be connected to the terminal which is marked with the letter N or coloured black.
- The wire which is coloured brown must be connected to the terminal which is marked with the letter L or coloured red.

IF YOU HAVE ANY DOUBT, CONSULT A QUALIFIED ELECTRICIAN.

This apparatus complies with the requirements of Council Directives 89/336/EEC and 73/23/EEC as amended by Council Directive 93/68/EEC.

Dieses Gerät entspricht den Anforderungen der EG-Richtlinien 89/336/EWG und 73/23/EWG mit Änderung 93/68/EWG.

Ce matériel répond aux exigences contenues dans les directives 89/336/CEE et 73/23/CEE modifiées par la directive 93/68/CEE.

Dit apparaat voldoet aan de eisen van de richtlijnen 89/336/EEG en 73/23/EEG, gewijzigd door 93/68/EEG.

Dette udstyr overholder kravene i direktiv nr. 89/336/EEC og 73/23/EEC med tillæg nr. 93/68/EEC.

Quest' apparecchio è conforme ai requisiti delle direttive 89/336/EEC e 73/23/EEC, come emendata dalla direttiva 93/68/EEC.

Αυτή η συσκευή συμμορφώνεται με τις απαιτήσεις των οδηγιών του Συμβουλίου 89/336/ΕΟΚ και 73/23/ΕΟΚ όπως τροποποιήθηκαν από την οδηγία του Συμβουλίου 93/68/ΕΟΚ.

Este equipamento obedece às exigências das directivas 89/336/CEE e 73/23/CEE, na sua versão corrigida pela directiva 93/68/CEE.

Este aparato satisface las exigencias de las Directivas 89/336/CEE y 73/23/CEE, modificadas por medio de la 93/68/CEE.

Denna utrustning uppfyller kraven enligt riktlinjerna 89/336/EEC och 73/23/EEC så som kompletteras av 93/68/EEC.

Dette produktet oppfyller betingelsene i direktivene 89/336/EEC og 73/23/EEC i endringen 93/68/EEC.

Tämä laite täyttää direktiivien 89/336/EEC ja 73/23/EEC vaatimukset, joita on muutettu direktiivillä 93/68/EEC.

Bu cihaz Konsey Direktifi 93/68/EEC tarafından düzeltilen 89/336/EEC ve 73/23/EEC Konsey Direktiflerinin gerekliliklerine uygundur.

Tento přístroj je v souladu s požadavky směrnic rady 89/336/EEC a 73/23/EEC, tak jak byly upraveny směrnicí rady 93/68/EEC.

See seade on vastavuses Nõukogu Direktiivis nr 89/336/EEC ja 73/23/EEC esitatud nõuetega, vastavalt Nõukogu Direktiivis nr 93/68/EEC esitatud parandustele

Ez a készülék megfelel a Tanács által kiadott, 89/336/EGK és 73/23/EGK Irányelveknek és az utóbbi módosító 93/68/EGK Irányelvnek

Ši ierice atbilst tehnikam prasibam pec 89/336/EEC un 73/23/EEC direktivam papildinats ar direktivu 93/68/EEC.

Šis prietais atitinka ES Tarybos direktyvu 89/336/EEC ir 73/23/EEC patikslintos direktyvos 93/68/EEC reikalavimus.

To urządzenie spełnia wymagania dyrektyw 89/336/EEC i 73/23/EEC wraz z poprawkami dyrektywy 93/68/EEC.

Tento přístroj je v súlade s požiadavkami smerníc rady 89/336/EEC a 73/23/EEC tak ako boli upravené smernicou rady 93/68/EEC.

Ta aparat je v skladu z zahtevami Direktiv Sveta 89/336/EEC in 73/23/EEC kot je navedeno v dopolnilu k Direktivi Sveta 93/68/EEC.

The supplied CD-ROM contains operation instructions in English, German, French, Swedish, Spanish, Italian, Dutch, Portuguese, Chinese (Traditional Chinese and Simplified Chinese) and Korean. Carefully read through the operation instructions before operating the projector.

Die mitgelieferte CD-ROM enthält Bedienungsanleitungen in Englisch, Deutsch, Französisch, Schwedisch, Spanisch, Italienisch, Niederländisch, Portugiesisch, Chinesisch (Traditionelles Chinesisch und einfaches Chinesisch) und Koreanisch. Bitte lesen Sie die Bedienungsanleitung vor der Verwendung des Projektors sorgfältig durch.

Le CD-ROM fourni contient les instructions de fonctionnement en anglais, allemand, français, suédois, espagnol, italien, néerlandais, portugais, chinois (chinois traditionnel et chinois simplifié) et coréen. Veuillez lire attentivement ces instructions avant de faire fonctionner le projecteur.

Den medföljande CD-ROM-skivan innehåller bruksanvisningar på engelska, tyska, franska, svenska, spanska, italienska, holländska, portugisiska, kinesiska (traditionell kinesiska och förenklad kinesiska) och koreanska. Läs noga igenom bruksanvisningen innan projektorn tas i bruk.

El CD-ROM suministrado contiene instrucciones de operación en inglés, alemán, francés, sueco, español, italiano, holandés, portugués, chino (chino tradicional y chino simplificado) y coreano. Lea cuidadosamente las instrucciones de operación antes de utilizar el proyector.

Il CD-ROM in dotazione contiene istruzioni per l'uso in inglese, tedesco, francese, svedese, spagnolo, italiano, olandese, portoghese, cinese (cinese tradizionale e cinese semplificato) e coreano. Leggere attentamente le istruzioni per l'uso prima di usare il proiettore.

De meegeleverde CD-ROM bevat handleidingen in het Engels, Duits, Frans, Zweeds, Spaans, Italiaans, Nederlands, Portugees, Chinees (Traditioneel Chinees en Vereenvoudigd Chinees) en Koreaans. Lees de handleiding zorgvuldig door voor u de projector in gebruik neemt.

O CD-ROM fornecido contém instruções de operação em Inglês, Alemão, Francês, Sueco, Espanhol, Italiano, Holandês, Português, Chinês, (Chinês Tradicional e Chinês Simplificado) e Coreano. Leia cuidadosamente todas as instruções de operação antes de operar o projetor.

附送之CD-ROM光碟中，有用英文、德文、法文、瑞典文、西班牙文、意大利文、荷蘭文、葡萄牙文、中文（繁體中文和簡體中文）和韓國文所寫的使用說明書。在操作本投影機之前，請務必仔細閱讀整本使用說明書。

附送之CD-ROM光碟中，有用英文、德文、法文、瑞典文、西班牙文、意大利文、荷蘭文、葡萄牙文、中文（繁体中文和简体中文）和韩国文所写的使用说明书。在操作本投影机之前，请务必仔细阅读整本使用说明书。

제공된 CD-ROM에는 영어, 독일어, 프랑스어, 스웨덴어, 스페인어, 이탈리아어, 네덜란드어, 포르투갈어, 중국어(번체자와 간체자), 그리고 한국어로 작성된 조작 설명서가 포함되어 있습니다. 프로젝터를 조작하기 전에 조작 지침을 상세하게 숙지하십시오.

Before using the projector, please read this operation manual carefully.

# Introduction

ENGLISH

There are two important reasons for prompt warranty registration of your new SHARP Projector, using the REGISTRATION CARD packed with the projector.

## 1. WARRANTY

This is to assure that you immediately receive the full benefit of the parts, service and labor warranty applicable to your purchase.

## 2. CONSUMER PRODUCT SAFETY ACT

To ensure that you will promptly receive any safety notification of inspection, modification, or recall that SHARP may be required to give under the 1972 Consumer Product Safety Act, PLEASE READ CAREFULLY THE IMPORTANT "LIMITED WARRANTY" CLAUSE.



U.S.A. ONLY

**WARNING:** High brightness light source. Do not stare into the beam of light, or view directly. Be especially careful that children do not stare directly into the beam of light.



**WARNING:** To reduce the risk of fire or electric shock, do not expose this product to rain or moisture.

See bottom of projector.

	<b>CAUTION</b> <b>RISK OF ELECTRIC SHOCK.</b> <b>DO NOT REMOVE SCREWS</b> <b>EXCEPT SPECIFIED USER</b> <b>SERVICE SCREW.</b>	
<b>CAUTION: TO REDUCE THE RISK OF ELECTRIC SHOCK,</b> <b>DO NOT REMOVE COVER.</b> <b>NO USER-SERVICEABLE PARTS EXCEPT LAMP UNIT.</b> <b>REFER SERVICING TO QUALIFIED SERVICE</b> <b>PERSONNEL.</b>		



The lightning flash with arrowhead symbol, within an equilateral triangle, is intended to alert the user to the presence of uninsulated "dangerous voltage" within the product's enclosure that may be of sufficient magnitude to constitute a risk or electric shock to persons.



The exclamation point within a triangle is intended to alert the user to the presence of important operating and maintenance (servicing) instructions in the literature accompanying the product.

**WARNING:** FCC Regulations state that any unauthorized changes or modifications to this equipment not expressly approved by the manufacturer could void the user's authority to operate this equipment.

U.S.A. ONLY

## INFORMATION

This equipment has been tested and found to comply with the limits for a Class A digital device, pursuant to Part 15 of the FCC Rules. These limits are designed to provide reasonable protection against harmful interference when the equipment is operated in a commercial environment. This equipment generates, uses, and can radiate radio frequency energy and, if not installed and used in accordance with the operation manual, may cause harmful interference to radio communications. Operation of this equipment in a residential area is likely to cause harmful interference, in which case the user will be required to correct the interference at his own expense.

U.S.A. ONLY

The enclosed computer cable must be used with the device. The cable is provided to ensure that the device complies with FCC Class A verification.

U.S.A. ONLY

## WARNING:

This is a Class A product. In a domestic environment this product may cause radio interference in which case the user may be required to take adequate measures.

## WARNING:

The cooling fan in this projector continues to run for about 90 seconds after the projector enters the standby mode. During normal operation, when putting the projector into the standby mode always use the ON/STANDBY button on the projector or on the remote control. Ensure the cooling fan has stopped before disconnecting the power cord.

DURING NORMAL OPERATION, NEVER TURN THE PROJECTOR OFF BY DISCONNECTING THE POWER CORD. FAILURE TO OBSERVE THIS WILL RESULT IN PREMATURE LAMP FAILURE.

## PRODUCT DISPOSAL

This projector utilizes tin-lead solder, and a pressurized lamp containing a small amount of mercury. Disposal of these materials may be regulated due to environmental considerations. For disposal or recycling information, please contact your local authorities or, if you are located in the United States of America, the Electronic Industries Alliance: [www.eiae.org](http://www.eiae.org).

## CAUTION ON LITHIUM BATTERY (for Remote Control unit)

If a battery is reversed (positive end where the negative end belongs and vice versa), it can overheat and rupture. This has happened when young children install batteries backwards. Warn children *not* to take out batteries or install them. *Parents should install the lithium battery in the remote control.*

## Caution Concerning Lamp Replacement

See "Replacing the Lamp" on page 55.

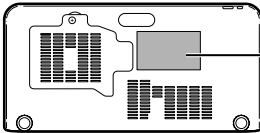

### ▲ LAMP REPLACEMENT CAUTION

BEFORE REMOVING THE SCREW, DISCONNECT POWER CORD. HOT SURFACE INSIDE. ALLOW 1 HOUR TO COOL BEFORE REPLACING THE LAMP. REPLACE WITH SAME SHARP LAMP UNIT TYPE AN-XR1LP ONLY.  
UV RADIATION : CAN CAUSE EYE DAMAGE. TURN OFF LAMP BEFORE SERVICING.  
HIGH PRESSURE LAMP - RISK OF EXPLOSION. POTENTIAL HAZARD OF GLASS PARTICLES IF LAMP HAS RUPTURED. HANDLE WITH CARE. SEE OPERATION MANUAL.

### ▲ PRECAUTIONS A OBSERVER LORS DU REMPLACEMENT DE LA LAMPE.

DEBRANCHER LE CORDON D'ALIMENTATION AVANT DE RETIRER LA VIS. L'INTERIEUR DU BOITIER ETANT EXTREMEMENT CHAUD, ATTENDRE 1 HEURE AVANT DE PROCEDER AU REMPLACEMENT DE LA LAMPE.  
NE REMPLACER QUE PAR UNE LAMPE SHARP DE TYPE AN-XR1LP.  
RAYONS ULTRAVIOLETS : PEUVENT ENDOMMAGER LES YEUX. ETEINDRE LA LAMPE AVANT DE PROCEDER A L'ENTRETIEN.

LAMPE A HAUTE PRESSION : RISQUE D'EXPLOSION. DANGER POTENTIEL DE PARTICULES DE VERRE EN CAS D'ECLAITEMENT DE LA LAMPE. A MANIPULER AVEC PRECAUTION. SE REPORTER AU MODE D'EMPLOI.

This SHARP projector uses a DMD panel. This very sophisticated panel contains 480,000 pixels micromirrors. As with any high technology electronic equipment such as large screen TVs, video systems and video cameras, there are certain acceptable tolerances that the equipment must conform to.

This unit has some inactive pixels within acceptable tolerances which may result in inactive dots on the picture screen. This will not affect the picture quality or the life expectancy of the unit.

# How to Read this Operation Manual

- In this operation manual, the illustration and the screen display are simplified for explanation, and may differ slightly from actual display.

## Using the Menu Screen

The menu can be operated to achieve two functions, adjustment and setting. (For setting the menu items, see pages 38 and 39.)

### Operating with the projector

When "PRJ - ADJ" - "Guide LEDs" is set to "On", the buttons used for menu adjustment on the projector light up.

Example: When  $\Delta$ ,  $\nabla$  and the MENU/HELP button light up on the projector, you can use those buttons for operation.

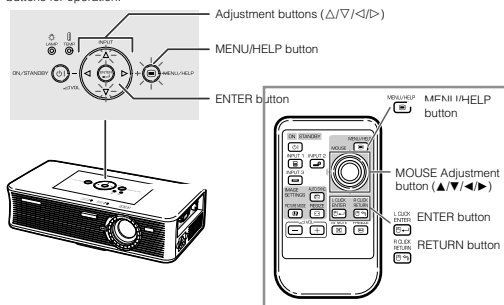

Buttons used in this operation

## Menu Selections (Adjustments)

Example: Adjusting "Bright".

- This operation can also be performed by using the buttons on the projector.

### 1 Press **MENU**.

- The "Picture" menu screen for the selected input mode is displayed.

### 2 Press **▶** or **◀** to display the other menu screen.

- The selected menu item is highlighted.

Example: "Picture" screen menu for INPUT 1 (RGB) mode

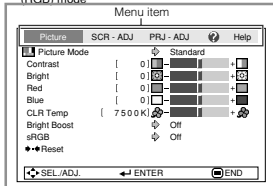

Button used in this step

On-screen display

**Info** .....Indicates safeguards for using the projector.

**Note** .....Indicates additional information for setting up and operating the projector.

## For Future Reference

Maintenance

➔ P. 52

Troubleshooting

➔ PP. 60 and 61

Index

➔ P. 65

# Contents

## Preparing

### Introduction

How to Read this Operation Manual .....	3
Contents .....	4
IMPORTANT SAFEGUARDS .....	6
How to Access the PDF Operation Manuals .....	10
Accessories .....	11
Part Names and Functions .....	12
Inserting the Lithium Battery .....	14
Usable Range .....	15

### Quick Start

Quick Start .....	16
-------------------	----

### Setup

Setting up the Projector .....	18
Setting up the Projector .....	18
Standard Setup (Front Projection) .....	18
Projecting a Reversed Image .....	19
Screen Size and Projection Distance ..	20

### Connections

Connections .....	21
Samples of Cables for Connection .....	22
Connecting to a Computer .....	23
Connecting to Video Equipment .....	24
Connecting the Power Cord .....	25

## Using

### Basic Operation

Turning the Projector On/Off .....	26
Turning the Projector on .....	26
Turning the Power off (Putting the Projector into Standby Mode) .....	26
Image Projection .....	27
About the Setup Guide .....	27
Adjusting the Projected Image .....	27
Switching the Input Mode .....	29
Adjusting the Volume .....	29
Displaying the Black Screen and Turning off the Sound Temporarily .....	29
Resize Mode .....	30

### Useful Features

Adjusting/Operating with the Remote Control .....	32
Auto Sync (Auto Sync Adjustment) .....	32
Freezing a Moving Image .....	32
Selecting the Picture Mode .....	32
Using Mouse Function .....	33
Menu Items .....	34
Using the Menu Screen .....	36
Menu Selections (Adjustments) .....	36
Menu Selections (Settings) .....	38

Picture Adjustment (“Picture” menu) ..	40
Selecting the Picture mode .....	40
Adjusting the Image .....	40
Adjusting the Color Temperature .....	41
Emphasizing the Contrast .....	41
Progressive .....	42
sRGB Setting .....	42

Adjusting the Projected Image (“SCR - ADJ” menu) .....	43
Setting the Resize Mode .....	43
Adjusting the Image Position .....	43
Keystone Correction .....	44
Setting On-screen Display .....	44
Selecting the Background Image .....	45
Setting the Setup Guide .....	45
Reversing/Inverting Projected Images .....	46
Selecting the On-screen Display Language .....	46

Setting the Projector Function (“PRJ - ADJ” menu) .....	47
Eco/Quiet Mode .....	47
Auto Search Function .....	47
Auto Power Off Function .....	48
Setting the Guide LEDs .....	48
System Lock Function .....	49
Setting/Changing the keycode .....	49
Setting the Confirmation Sound .....	50
Checking the Lamp Life Status .....	50
Troubleshooting with “Help” menu .....	51
Displaying “Help” menu screen .....	51



## Reference

### Appendix

Maintenance .....	52
Maintenance Indicators .....	53
Regarding the Lamp .....	55
Lamp .....	55
Caution Concerning the Lamp .....	55
Replacing the Lamp .....	55
Removing and Installing the Lamp Unit .....	56
Resetting the Lamp Timer .....	57

Connecting Pin Assignments .....	58
Computer Compatibility Chart .....	59
Troubleshooting .....	60
For SHARP Assistance .....	62
Specifications .....	63
Dimensions .....	64
Index .....	65

# IMPORTANT SAFEGUARDS

**CAUTION:** Please read all of these instructions before you operate this product and save these instructions for later use.

Electrical energy can perform many useful functions. This product has been engineered and manufactured to assure your personal safety. BUT IMPROPER USE CAN RESULT IN POTENTIAL ELECTRICAL SHOCK OR FIRE HAZARDS. In order not to defeat the safeguards incorporated in this product, observe the following basic rules for its installation, use and servicing.

## 1. Read Instructions

All the safety and operating instructions should be read before the product is operated.

## 2. Retain Instructions

The safety and operating instructions should be retained for future reference.

## 3. Heed Warnings

All warnings on the product and in the operating instructions should be adhered to.

## 4. Follow Instructions

All operating and use instructions should be followed.

## 5. Cleaning

Unplug this product from the wall outlet before cleaning. Do not use liquid cleaners or aerosol cleaners. Use a damp cloth for cleaning.

## 6. Attachments

Do not use attachments not recommended by the product manufacturer as they may cause hazards.

## 7. Water and Moisture

Do not use this product near water—for example, near a bath tub, wash bowl, kitchen sink, or laundry tub; in a wet basement; or near a swimming pool; and the like.

## 8. Accessories

Do not place this product on an unstable cart, stand, tripod, bracket, or table. The product may fall, causing serious injury to a child or adult, and serious damage to the product. Use only with a cart, stand, tripod, bracket, or table recommended by the manufacturer, or sold with the product. Any mounting of the product should follow the manufacturer's instructions, and should use a mounting accessory recommended by the manufacturer.

## 9. Transportation

A product and cart combination should be moved with care. Quick stops, excessive force, and uneven surfaces may cause the product and cart combination to overturn.



## 10. Ventilation

Slots and openings in the cabinet are provided for ventilation to ensure reliable operation of the product and to protect it from overheating, and these openings must not be blocked or covered. The openings should never be blocked by placing the product on a bed, sofa, rug, or other similar surface. This product should not be placed in a built-in installation such as a bookcase or rack unless proper ventilation is provided or the manufacturer's instructions have been adhered to.

## 11. Power Sources

This product should be operated only from the type of power source indicated on the marking label. If you are not sure of the type of power supply to your home, consult your product dealer or local power company. For products intended to operate from battery power, or other sources, refer to the operating instructions.

## 12. Grounding or Polarization

This product is provided with one of the following types of plugs. If the plug should fail to fit into the power outlet,

please contact your electrician.

Do not defeat the safety purpose of the plug.

a. Two-wire type (mains) plug.

b. Three-wire grounding type (mains) plug with a grounding terminal.

This plug will only fit into a grounding type power outlet.

## 13. Power-Cord Protection

Power-supply cords should be routed so that they are not likely to be walked on or pinched by items placed upon or against them, paying particular attention to cords at plugs, convenience receptacles, and the point where they exit from the product.

## 14. Lightning

For added protection for this product during a lightning storm, or when it is left unattended and unused for long periods of time, unplug it from the wall outlet and disconnect the cable system. This will prevent damage to the product due to lightning and power-line surges.

**15. Overloading**

Do not overload wall outlets, extension cords, or integral convenience receptacles as this can result in a risk of fire or electric shock.

**16. Object and Liquid Entry**

Never push objects of any kind into this product through openings as they may touch dangerous voltage points or short-out parts that could result in a fire or electric shock. Never spill liquid of any kind on the product.

**17. Servicing**

Do not attempt to service this product yourself as opening or removing covers may expose you to dangerous voltage or other hazards. Refer all servicing to qualified service personnel.

**18. Damage Requiring Service**

Unplug this product from the wall outlet and refer servicing to qualified service personnel under the following conditions:

- a. When the power-supply cord or plug is damaged.
- b. If liquid has been spilled, or objects have fallen into the product.
- c. If the product has been exposed to rain or water.
- d. If the product does not operate normally by following the operating instructions. Adjust only those controls that are covered by the operating instructions, as an improper adjustment of other controls may result in damage and will often require extensive work by a qualified technician to restore the product to normal operation.
- e. If the product has been dropped or damaged in any way.
- f. When the product exhibits a distinct change in performance, this indicates a need for service.

**19. Replacement Parts**

When replacement parts are required, be sure the service technician has used replacement parts specified by the manufacturer or have the same characteristics as the original part. Unauthorized substitutions may result in fire, electric shock, or other hazards.

**20. Safety Check**

Upon completion of any service or repairs to this product, ask the service technician to perform safety checks to determine that the product is in proper operating condition.

**21. Heat**

This product should be situated away from heat sources such as radiators, heat registers, stoves, or other products (including amplifiers) that produce heat.

- DLP™ (Digital Light Processing) and DMD™ (Digital Micromirror Device) are trademarks of Texas Instruments, Inc.
- Microsoft and Windows are registered trademarks of Microsoft Corporation in the United States and/or other countries.
- PC/AT is a registered trademark of International Business Machines Corporation in the United States.
- Adobe Reader is a trademark of Adobe Systems Incorporated.
- Macintosh is a registered trademark of Apple Computer, Inc. in the United States and/or other countries.
- All other company or product names are trademarks or registered trademarks of their respective companies.

## Be sure to read the following safeguards when setting up your projector.

### Caution concerning the lamp unit

- Potential hazard of glass particles if lamp ruptures. In case of lamp rupture, contact your nearest Sharp Authorized Projector Dealer or Service Center for a replacement. See “Replacing the Lamp” on page 55.

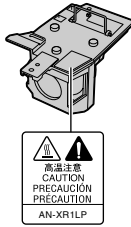

### Caution concerning the setup of the projector

- For minimal servicing and to maintain high image quality, SHARP recommends that this projector be installed in an area free from humidity, dust and cigarette smoke. When the projector is subjected to these environments, the vents and lens must be cleaned more often. As long as the projector is regularly cleaned, use in these environments will not reduce the overall operation life of the unit. Internal cleaning should only be performed by a Sharp Authorized Projector Dealer or Service Center.

### Do not set up the projector in places exposed to direct sunlight or bright light.

- Position the screen so that it is not in direct sunlight or room light. Light falling directly on the screen washes out the colors, making viewing difficult. Close the curtains and dim the lights when setting up the screen in a sunny or bright room.

### Caution regarding placing of the projector.

- Place the projector on a level site within the adjustment range of the adjustment foot.

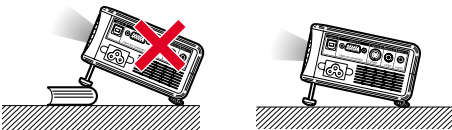

### Do not use the projector upside down.

- This can cause personal injury due to rise in internal temperature.

### Warning about placing the projector in a high position

- When placing the projector in a high position, be sure to secure it carefully to avoid personal injury caused by the projector falling down.

### Do not subject the projector to hard impact and/or vibration.

- Take care with the lens so as not to hit or damage the surface of the lens.

### Rest your eyes occasionally.

- Continuously watching the screen for long hours will cause eye strain. Be sure to occasionally rest your eyes.

### Avoid locations with extremes of temperature.

- The operating temperature of the projector is from 41°F to 95°F (+5°C to +35°C).
- The storage temperature of the projector is from -4°F to 140°F (-20°C to +60°C).

### Do not block the exhaust and intake vents.

- Allow at least 11 <sup>13</sup>/<sub>16</sub> inches (30 cm) of space between the exhaust vent and the nearest wall or obstruction.
- Be sure that the intake vent and the exhaust vent are not obstructed.
- If the cooling fan becomes obstructed, a protection circuit will automatically put the projector into the standby mode to prevent over-heat damage. This does not indicate a malfunction. (See pages 53 and 54.) Remove the projector power cord from the wall outlet and wait at least 10 minutes. Place the projector where the intake and exhaust vents are not blocked, plug the power cord back in and turn on the projector. This will return the projector to the normal operating condition.

## Caution regarding transportation of the projector

- When transporting the projector, be sure not to subject it to hard impact and/or vibration, as this can result in damage. Take extra care with the lens. Before moving the projector, be sure to unplug the power cord from the wall outlet, and disconnect any other cables connected to it.
- Do not carry the projector by holding the lens.
- When transporting the projector, be sure to place the projector in the supplied soft case. (See page 11.)

## Other connected equipment

- When connecting a computer or other audio-visual equipment to the projector, make the connections AFTER unplugging the power cord of the projector from the AC outlet and turning off the equipment to be connected.
- Please read the operation manuals of the projector and the equipment to be connected for instructions on how to make the connections.

## Using the projector in other countries

- The power supply voltage and the shape of the plug may vary depending on the region or country you are using the projector in. When using the projector overseas, be sure to use an appropriate power cord for the country you are in.

## Temperature monitor function



- If the projector starts to overheat due to setup problems or blockage of the air vents, “” and “TEMP.” will illuminate in the lower left corner of the picture. If the temperature continues to rise, the lamp will turn off, the temperature warning indicator on the projector will blink, and after a 90-second cooling-off period the projector will enter the standby mode. Refer to “Maintenance Indicators” on page 53 for details.

## Info

- The cooling fan regulates the internal temperature, and its performance is automatically controlled. The sound of the fan may change during projector operation due to changes in the fan speed. This does not indicate malfunction.
- Do not unplug the power cord during projection or cooling fan operation. This can cause damage due to rise in internal temperature, as the cooling fan also stops.

# How to Access the PDF Operation Manuals

PDF operation manuals in several languages are included in the CD-ROM, so that you can work with the projector, even if you do not have this manual. To utilize these manuals, you need to install Adobe Reader on your computer (Windows or Macintosh).

Please download Adobe Reader from the Internet (<http://www.adobe.com>).

## Accessing the PDF Manuals

### For Windows:

- ① Insert the CD-ROM in the CD-ROM drive.
- ② Double click the “My Computer” icon.
- ③ Double click the “CD-ROM” drive.
- ④ Double click the language (name of the folder) that you want to view.
- ⑤ Double click the “XR1” pdf file to access the projector manuals.

### For Macintosh:

- ① Insert the CD-ROM in the CD-ROM drive.
- ② Double click the “CD-ROM” icon.
- ③ Double click the language (name of the folder) that you want to view.
- ④ Double click the “XR1” pdf file to access the projector manuals.

### Note

- If the desired pdf file cannot be opened by double clicking the mouse, start Adobe Reader first, then specify the desired file using the “File”, “Open” menu.

# Accessories

## Supplied accessories



Remote control  
RRMCGA256WJSA



Lithium battery  
(CR2025)  
UBATL0011TAZZ

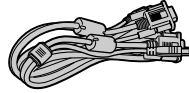

RGB/USB cable  
(6' (1.8 m))  
QCNWGA047WJPZ



Cable tie x 2  
UBNDTA015WJZZ

- For the RGB/USB cable
- For the power cord

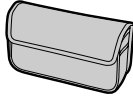

Soft case  
GCASNA011WJZZ

- Projector manual CD-ROM  
UDSKAA045WJZZ
- Operation manual (this manual)

Power cord\*

(1)

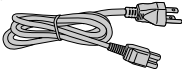

For U.S., Canada,  
etc.  
(6' (1.8 m))  
QACCCDA029WJPZ

(2)

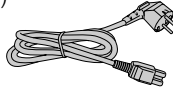

For Europe, except  
U.K.  
(6' (1.8 m))  
QACCVAA006WJPZ

(3)

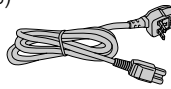

For U.K., Hong Kong  
and Singapore  
(6' (1.8 m))  
QACCBAA015WJPZ

(4)

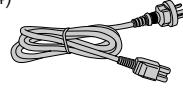

For Australia, New  
Zealand and Oceania  
(6' (1.8 m))  
QACCLA024WJPZ

\* Use the power cord that corresponds to the wall outlet in your country.

## Optional accessories

- 3 RCA to 15-pin D-sub cable (9'10" (3.0 m))
- Lamp unit

AN-C3CP  
AN-XR1LP



### Note

- Some of the optional accessories may not be available depending on the region. Please check with your nearest Sharp Authorized Projector Dealer or Service Center.

## Carrying the Projector

### Using the Soft Case

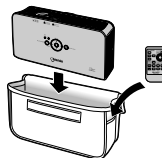
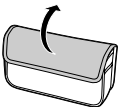

### Info

- Be sure the projector has cooled down sufficiently before placing it in the case.
- This soft case is only for storing and carrying the projector.
- Shipping the projector in the soft case as a parcel may cause damage to the projector. If you send the projector in the carrying case as a parcel, be sure to place it in a sturdy case and with enough shock absorbing material to avoid any damage.

## Tying the Cables

Tie the cable using the supplied cable ties.

Power cord

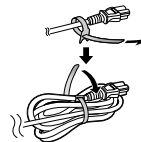

RGB/USB cable

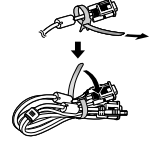

### Note

- You cannot store the supplied cables within the soft case. When transporting the projector, prepare a bag for these cables.

# Part Names and Functions

Numbers in    refer to the main pages in this operation manual where the topic is explained.

## Projector

### Top View

Lamp indicator

**ON/STANDBY button**  
For turning the power on and putting the projector into the standby mode.

**ENTER button**  
For setting items selected or adjusted on the menu.

**Adjustment buttons**  
( $\Delta/\nabla$ / $\leftarrow/\rightarrow$ )  
For selecting menu items.

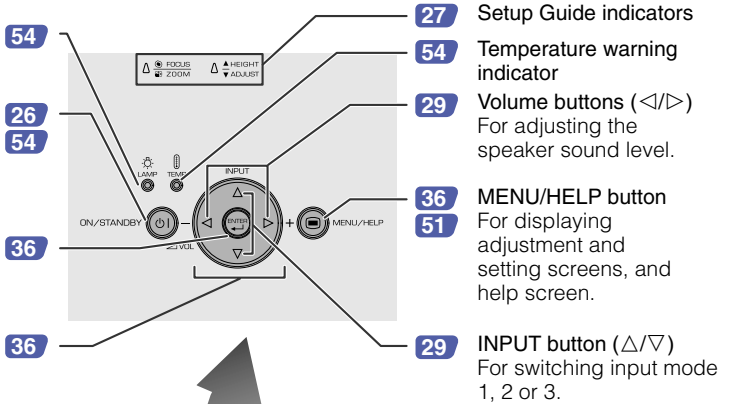

### Front View

**HEIGHT ADJUST button**

**Zoom knob**  
For enlarging/reducing the picture.

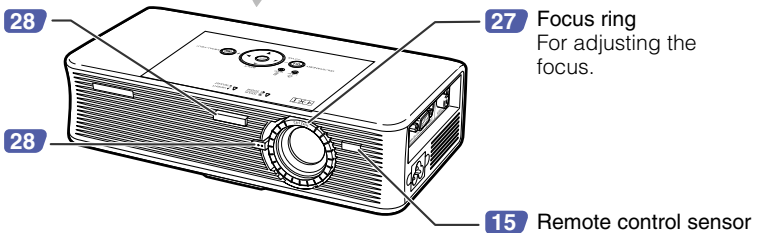

### Indicators on the Projector

ON/STANDBY button	Red on	Normal (Standby)
	Green on	Normal (Power on)
	Red blinks	Abnormal (See page 54.)
Lamp indicator	Green on	Normal
	Green blinks	The lamp is warming up or shutting down.
	Red on	The lamp is shut down abnormally or requires to be changed. (See page 54.)
Temperature warning indicator	Off	Normal
	Red on	The internal temperature is abnormally high. (See page 54.)
FOCUS/ZOOM indicator	FOCUS ZOOM	Orange blinks "1 FOCUS" or "3 ZOOM" is highlighted on the Setup Guide. (See page 27.)
HEIGHT ADJUST indicator	HEIGHT ADJUST	Orange blinks "2 HEIGHT ADJUST" is highlighted on the Setup Guide. (See page 27.)



Numbers in    refer to the main pages in this operation manual where the topic is explained.

## Side View

**Terminals** Refer to “INPUT Terminals and Connectable Main Equipment” on page 21.

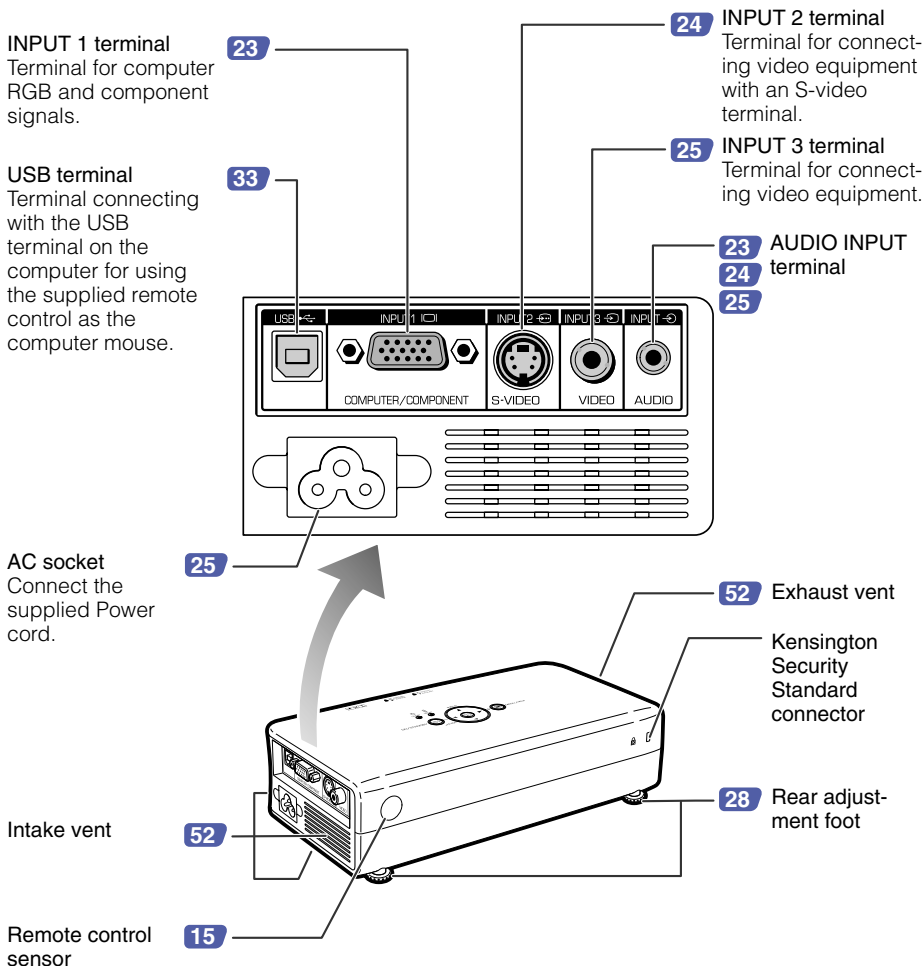

### Using the Kensington Lock

- This projector has a Kensington Security Standard connector for use with a Kensington MicroSaver Security System. Refer to the information that came with the system for instructions on how to use it to secure the projector.

# Part Names and Functions (Continued)

Numbers in **■** refer to the main pages in this operation manual where the topic is explained.

**ON/STANDBY button**  
For turning the power on and putting the projector into the standby mode.

**INPUT 1, 2, and 3 buttons**  
For switching to the respective input modes.

**AUTO SYNC button**  
For automatically adjusting images when connected to a computer.

**RESIZE button**  
For switching the screen size (NORMAL, BORDER, etc.).

**PICTURE MODE buttons**  
For switching the picture mode.

**Volume buttons**  
For adjusting the speaker sound level.

**26**

**29**

**32**

**30**

**32**

**29**

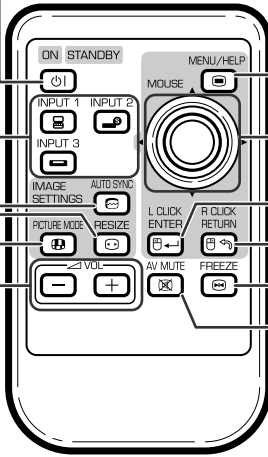

**36** MENU/HELP button  
**51** For displaying adjustment and setting screens, and help screen.

**33** MOUSE/Adjustment buttons (▲/▼/◀/▶)  
**36**

- For moving the computer cursor when connecting the projector USB terminal to the computer with RGB/USB cable.
- For selecting menu items.

**33** L CLICK/ENTER button  
**36**

- For the Left click when connecting the projector USB terminal to the computer with RGB/USB cable.
- For setting items selected or adjusted on the menu.

**33** R CLICK/RETURN button  
**36**

- For the Right click when connecting the projector USB terminal to the computer with RGB/USB cable.
- For undoing an operation or returning to the previous display.

**32** FREEZE button  
For freezing images.

**29** AV MUTE button  
For temporarily displaying the black screen and turning off the sound.

## Note

- All the buttons on the remote control, except the MOUSE/Adjustment button, are made of luminous rubber, that is visible in the dark. (The luminous light weakens over time.)

## Inserting the Lithium Battery

**1** While pressing the tab (①), pull the battery holder (②).

**2** Pull the battery holder.

**3** Insert the supplied lithium battery (CR2025).  
• Insert the lithium battery with the + side of the battery facing the + mark of the battery holder.

**4** Insert the battery holder into the remote control.

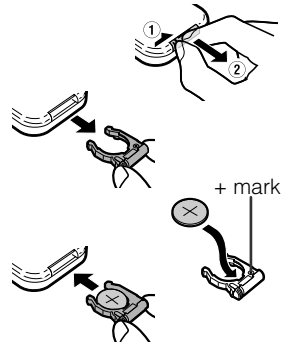

## Usable Range

The remote control can be used to control the projector within the ranges shown in the illustration.

### Note

- The signal from the remote control can be reflected off a screen for easy operation. However, the effective distance of the signal may differ depending on the screen material.

### When using the remote control

- Be sure not to drop, expose to moisture or high temperature.
- The remote control may malfunction under a fluorescent lamp. In this case, move the projector away from the fluorescent lamp.

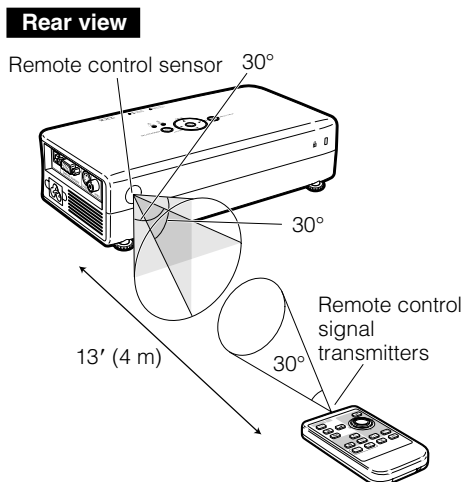
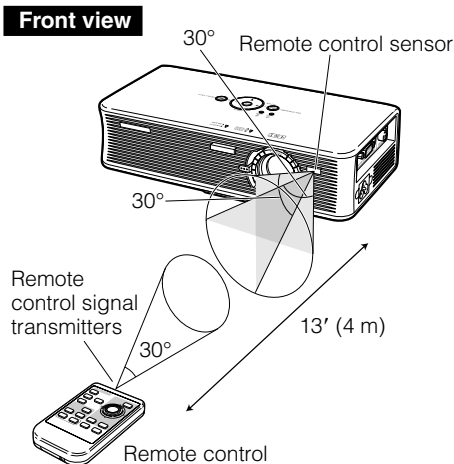

### Notes the Use of the Lithium Battery

**CAUTION** The battery used in this device may present a risk of fire or chemical burn if mis-treated. Do not recharge, disassemble, heat above 212°F (100°C), or incinerate. Replace battery with the type CR2025 only. Use of another battery may present a risk of fire or explosion. Dispose of used battery promptly. Keep away from children. Do not disassemble and do not dispose of in fire.

- See page 2 for caution on the lithium battery.
- Do not short-circuit, recharge, disassemble, or heat the lithium battery.
- Should the lithium battery leak, wipe the battery compartment clean, and then insert a new battery.

### Replacement of lithium battery

- Replace with a new battery (CR2025) if remote control operation often fails.
- When disposing the battery, follow the recycling or disposal regulations in your community.

# Quick Start

This section shows the basic operation (projector connecting with the computer). For details, see the page described below for each step.

## Setup and Projection

In this section, connection of the projector and the computer is explained using one example.

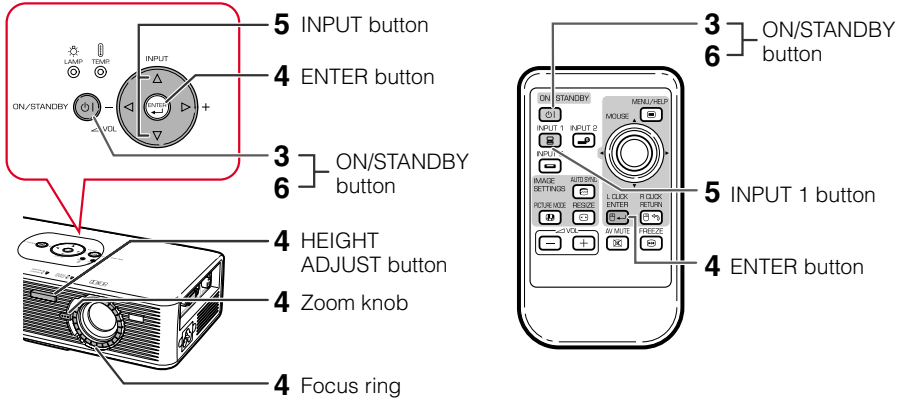

### 1. Place the projector facing a wall or a screen

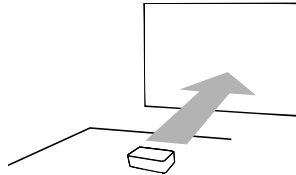

→ P. 18

### 2. Connect the projector to the computer and plug the power cord into the AC socket of the projector

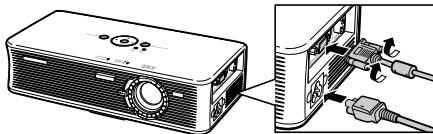

When connecting equipment other than the computer, see pages 24 and 25.

→ PP. 21–25

### 3. Press the ON/STANDBY button to turn the projector on

On the projector



On the remote control



→ P. 26

## 4. Adjust the projected image with the Setup Guide

- 1** After the projector turns on, the Setup Guide appears. (When “Setup Guide” is set to “On”. → page 45)

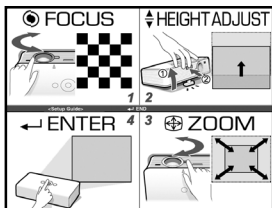

- Refer to the Setup Guide screen to adjust the focus, angle and zoom.
- Press **ENTER** to finish the Setup Guide.

- 2** Focus (See page 27.)

- Bring the projected image into focus using the focus ring.

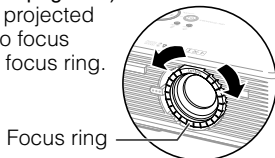

- 3** Angle (See page 28.)

- Adjust the projector angle using the HEIGHT ADJUST button.

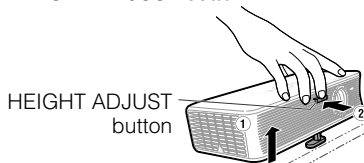

- 4** Zoom (See page 28.)

- Adjust the projected image size using the zoom knob.

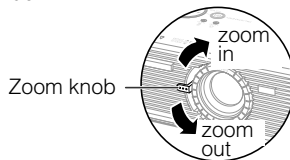

- 5** After adjusting the focus, height and screen size, press **ENTER** to finish the Setup Guide.

→ P. 27

## 5. Select the INPUT mode

Select the “INPUT 1” using the INPUT button on the projector or **INPUT 1** on the remote control.

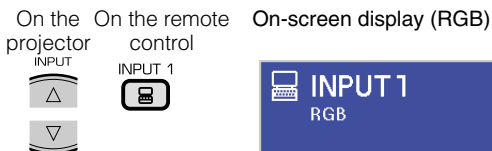

- When pressing the INPUT button on the projector, input mode switches in order of **INPUT1↔INPUT2↔INPUT3**.
- When using the remote control, press the **INPUT 1** / **INPUT 2** / **INPUT 3** button to switch the INPUT mode.

→ P. 29

## 6. Turn the Power off

Press the ON/STANDBY button, then press that button again while the confirmation message is displayed, to put the projector into the standby mode.

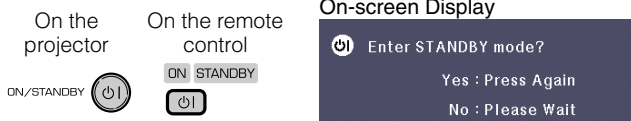

- While the cooling fan is running, the Adjustment buttons blinks. (When “Guide LEDs” is set to “On”. → page 48)
- Unplug the power cord from the AC outlet after the cooling fan stops.

→ P. 26

# Setting up the Projector

## Setting up the Projector

Position the projector perpendicular to the screen with the projector's feet flat and level to achieve an optimal image.

### Note

- For an optimal image, position the screen so that it is not in direct sunlight or room light. Light falling directly on the screen washes out the colors, making viewing difficult. Close the curtains and dim the lights when setting up the screen in a sunny or bright room.

## Standard Setup (Front Projection)

- Place the projector at the required distance from the screen according to the desired picture size. (See page 20.)

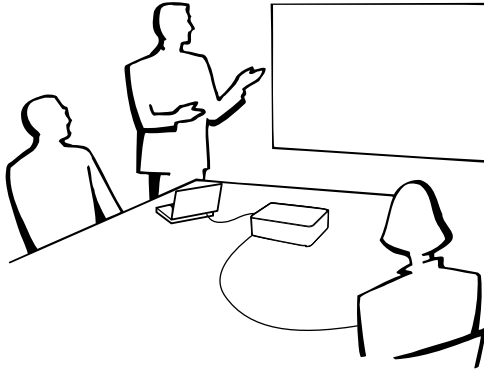

### Example of standard setup

#### Side View

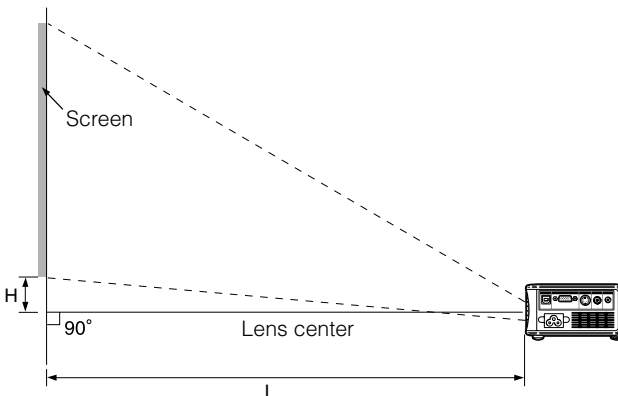

## Projecting a Reversed Image

### Projection from behind the Screen

- Place a translucent screen between the projector and the audience.
- Reverse the image by setting “Rear” in the “PRJ Mode” menu. (See page 46.)

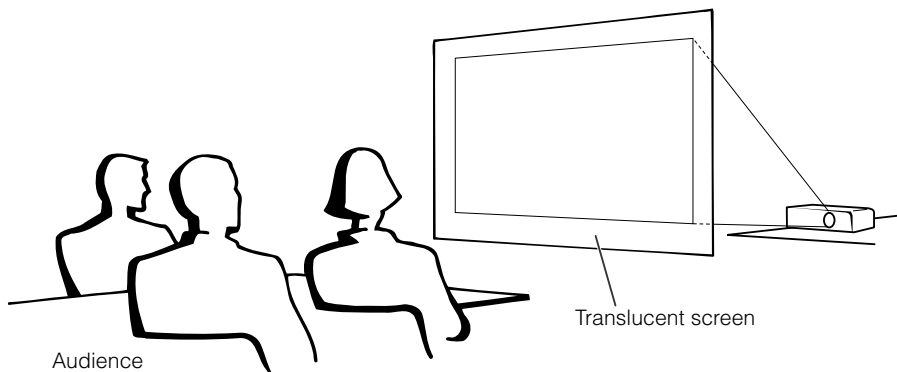

### Projection Using a Mirror

- Place a mirror (normal flat type) in front of the lens.
- When the translucent screen is placed between the mirror and audience, set to “Front” in the “PRJ Mode” menu. (See page 46.)
- When the mirror is placed on the audience side, set to “Rear” in the “PRJ Mode” menu. (See page 46.)

Set to “Front”

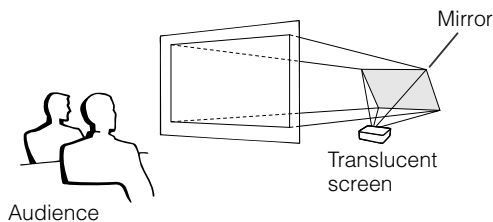

Set to “Rear”

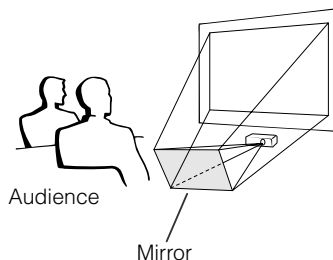

#### Info

- When using a mirror, be sure to carefully position both the projector and the mirror so the light does not shine into the eyes of the audience.

# Setting up the Projector (Continued)

## Screen Size and Projection Distance

### NORMAL Mode (4:3)

Picture (Screen) size			Projection distance [L]		Distance from the bottom of the image to the lens center [H]
Diag. [χ]	Width	Height	Minimum [L1]	Maximum [L2]	
280" (711 cm)	569 cm (224")	427 cm (168")	9.8 m (32' 2")		- 61.5 cm (- 24 <sup>7</sup> / <sub>32</sub> "
250" (635 cm)	508 cm (200")	381 cm (150")	8.8 m (28' 9")		- 54.9 cm (- 21 <sup>5</sup> / <sub>8</sub> "
200" (508 cm)	406 cm (160")	305 cm (120")	7.0 m (23' 0")	8.1 m (26' 8")	- 43.9 cm (- 17 <sup>19</sup> / <sub>64</sub> "
150" (381 cm)	305 cm (120")	229 cm (90")	5.3 m (17' 3")	6.1 m (20' 0")	- 33.0 cm (- 12 <sup>31</sup> / <sub>32</sub> "
100" (254 cm)	203 cm (80")	152 cm (60")	3.5 m (11' 6")	4.1 m (13' 4")	- 22.0 cm (- 8 <sup>21</sup> / <sub>32</sub> "
84" (213 cm)	171 cm (67")	128 cm (50")	2.9 m (9' 8")	3.4 m (11' 2")	- 18.5 cm (- 7 <sup>17</sup> / <sub>64</sub> "
72" (183 cm)	146 cm (58")	110 cm (43")	2.5 m (8' 3")	2.9 m (9' 7")	- 15.8 cm (- 6 <sup>15</sup> / <sub>64</sub> "
60" (152 cm)	122 cm (48")	91 cm (36")	2.1 m (6' 11")	2.4 m (8' 0")	- 13.2 cm (- 5 <sup>3</sup> / <sub>16</sub> "
40" (102 cm)	81 cm (32")	61 cm (24")	1.4 m (4' 7")	1.6 m (5' 4")	- 8.8 cm (- 3 <sup>29</sup> / <sub>64</sub> "
30" (76 cm)	61 cm (24")	46 cm (18")	1.1 m (3' 5")	1.2 m (4' 0")	- 6.6 cm (- 2 <sup>19</sup> / <sub>32</sub> "

χ: Picture size (diag.) (in/cm)

L: Projection distance (m/ft)

L1: Minimum projection distance (m/ft)

L2: Maximum projection distance (m/ft)

H: Distance from the bottom of the image to the lens center (cm/in)

The formula for picture size and projection distance

[m/cm]

L1 (m) = 0.03503χ

L2 (m) = 0.04064χ

H (cm) = - 0.21971χ

[Feet/inches]

L1 (ft) = 0.03503χ / 0.3048

L2 (ft) = 0.04064χ / 0.3048

H (in) = - 0.21971χ / 2.54

### STRETCH Mode (16:9)

Picture (Screen) size			Projection distance [L]		Distance from the bottom of the image to the lens center [H]	Adjustable range of image position [S]
Diag. [χ]	Width	Height	Minimum [L1]	Maximum [L2]		
260" (660 cm)	576 cm (227")	324 cm (127")	9.9 m (32' 7")		- 116.2 cm (- 45 <sup>3</sup> / <sub>4</sub> "	± 54.0 cm (± 21 <sup>1</sup> / <sub>4</sub> "
250" (635 cm)	553 cm (218")	311 cm (123")	9.5 m (31' 4")		- 111.7 cm (- 43 <sup>69</sup> / <sub>64</sub> "	± 51.9 cm (± 20 <sup>27</sup> / <sub>64</sub> "
225" (572 cm)	498 cm (196")	280 cm (110")	8.6 m (28' 2")	10.0 m (32' 8")	- 100.6 cm (- 39 <sup>19</sup> / <sub>32</sub> "	± 46.7 cm (± 18 <sup>25</sup> / <sub>64</sub> "
200" (508 cm)	443 cm (174")	249 cm (98")	7.6 m (25' 1")	8.9 m (29' 1")	- 89.4 cm (- 35 <sup>3</sup> / <sub>16</sub> "	± 41.5 cm (± 16 <sup>11</sup> / <sub>32</sub> "
150" (381 cm)	332 cm (131")	187 cm (74")	5.7 m (18' 9")	6.6 m (21' 9")	- 67.0 cm (- 26 <sup>29</sup> / <sub>64</sub> "	± 31.1 cm (± 12 <sup>1</sup> / <sub>4</sub> "
133" (338 cm)	294 cm (116")	166 cm (65")	5.1 m (16' 8")	5.9 m (19' 4")	- 59.4 cm (- 23 <sup>13</sup> / <sub>32</sub> "	± 27.6 cm (± 10 <sup>7</sup> / <sub>8</sub> "
106" (269 cm)	235 cm (92")	132 cm (52")	4.0 m (13' 3")	4.7 m (15' 5")	- 47.4 cm (- 18 <sup>21</sup> / <sub>32</sub> "	± 22.0 cm (± 8 <sup>21</sup> / <sub>32</sub> "
100" (254 cm)	221 cm (87")	125 cm (49")	3.8 m (12' 6")	4.4 m (14' 6")	- 44.7 cm (- 17 <sup>19</sup> / <sub>32</sub> "	± 20.8 cm (± 8 <sup>11</sup> / <sub>64</sub> "
92" (234 cm)	204 cm (80")	115 cm (45")	3.5 m (11' 6")	4.1 m (13' 4")	- 41.1 cm (- 16 <sup>3</sup> / <sub>16</sub> "	± 19.1 cm (± 7 <sup>39</sup> / <sub>64</sub> "
84" (213 cm)	186 cm (73")	105 cm (41")	3.2 m (10' 6")	3.7 m (12' 2")	- 37.5 cm (- 14 <sup>26</sup> / <sub>32</sub> "	± 17.4 cm (± 6 <sup>56</sup> / <sub>64</sub> "
72" (183 cm)	159 cm (63")	90 cm (35")	2.7 m (9' 0")	3.2 m (10' 6")	- 32.2 cm (- 12 <sup>49</sup> / <sub>64</sub> "	± 14.9 cm (± 5 <sup>57</sup> / <sub>64</sub> "
60" (152 cm)	133 cm (52")	75 cm (29")	2.3 m (7' 6")	2.7 m (8' 9")	- 26.8 cm (- 10 <sup>9</sup> / <sub>16</sub> "	± 12.5 cm (± 4 <sup>29</sup> / <sub>32</sub> "
40" (102 cm)	89 cm (35")	50 cm (20")	1.5 m (5' 0")	1.8 m (5' 10")	- 17.9 cm (- 7 <sup>1</sup> / <sub>32</sub> "	± 8.3 cm (± 3 <sup>17</sup> / <sub>64</sub> "
30" (76 cm)	66 cm (26")	37 cm (15")	1.1 m (3' 9")	1.3 m (4' 4")	- 13.4 cm (- 5 <sup>9</sup> / <sub>32</sub> "	± 6.2 cm (± 2 <sup>29</sup> / <sub>64</sub> "

χ: Picture size (diag.) (in/cm)

L: Projection distance (m/ft)

L1: Minimum projection distance (m/ft)

L2: Maximum projection distance (m/ft)

H: Distance from the bottom of the image to the lens center (cm/in)

S: Adjustable range of image position (cm/in) See page 43.

The formula for picture size and projection distance

[m/cm]

L1 (m) = 0.038169χ

L2 (m) = 0.044276χ

H (cm) = - 0.44691χ

S (cm) = ± 0.20754χ

[Feet/inches]

L1 (ft) = 0.038169χ / 0.3048

L2 (ft) = 0.044276χ / 0.3048

H (in) = - 0.44691χ / 2.54

S (in) = ± 0.20754χ / 2.54

#### Note

- There may be an error of ±3% in the above values.
- Values with a minus (-) sign indicate that the lens center is lower than the bottom of the projected image.







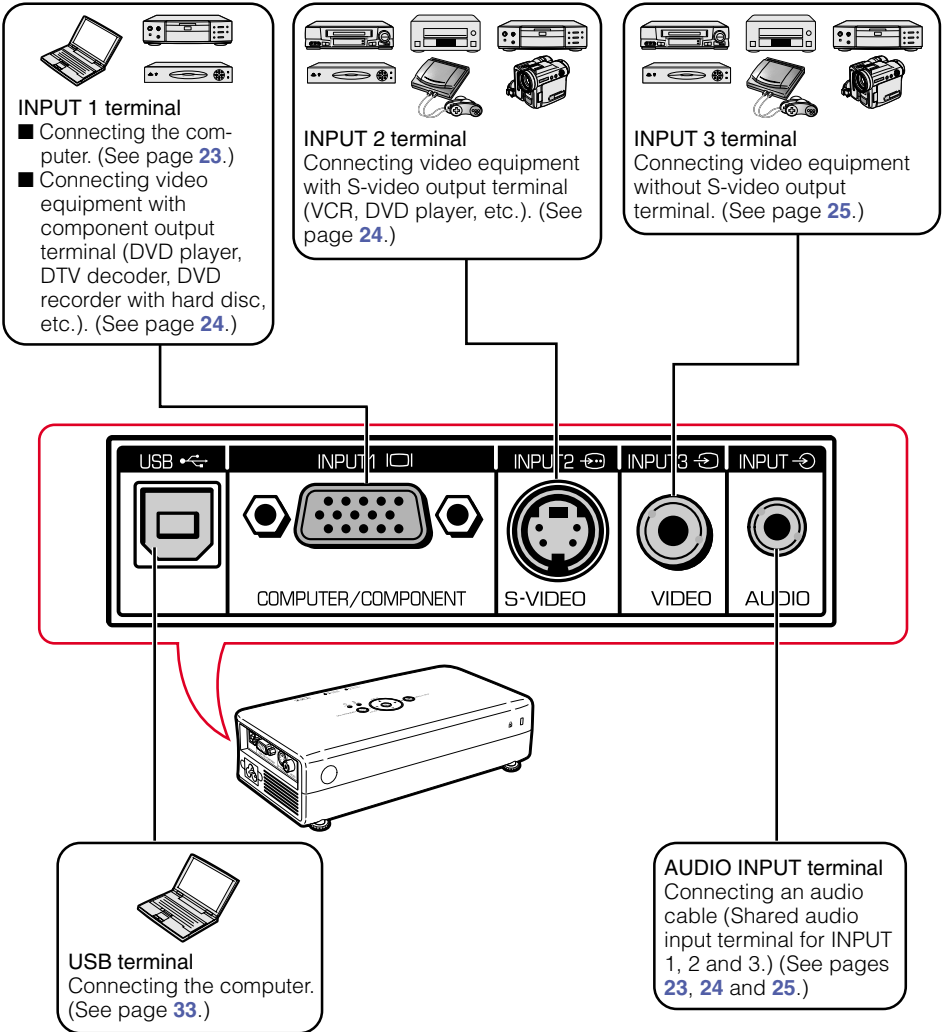





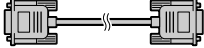
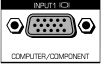
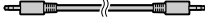

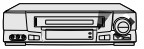
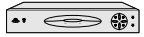
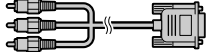
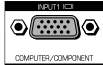
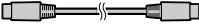

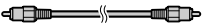

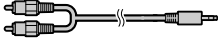

# Connections

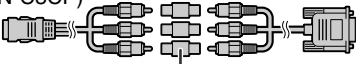
## INPUT Terminals and Connectable Main Equipment

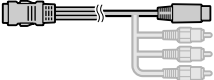

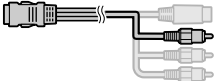
# Samples of Cables for Connection

- For more details of connection and cables, refer to the operation manual of the connecting equipment.
- You may need other cables or connectors not listed above.

Equipment	Input Signal	Cable	Terminal on the projector
	RGB video	RGB/USB cable (supplied) 	INPUT1 
	Computer audio	ø3.5 mm stereo audio cable 	AUDIO INPUT 
  	Component video	3 RCA (Component) to 15-pin D-sub cable (optional, AN-C3CP) 	INPUT1 
	S-video	S-video cable (commercially available) 	INPUT2 
	Video	Video cable (commercially available) 	INPUT3 
	Audio	ø3.5 mm minijack to RCA audio cable (commercially available) 	AUDIO INPUT 
 	Component video	Cables for a camera or a video game/3 RCA (Component) to 15-pin D-sub cable (optional, AN-C3CP)  Cable adapter (commercially available)	INPUT1 
	S-video	Cables for a camera or a video game 	INPUT2 
	Video	Cables for a camera or a video game 	INPUT3 
	Audio	Cables for a camera or a video game/ø3.5 mm minijack to RCA audio cable (commercially available)  Cable adapter (commercially available)	AUDIO INPUT 

# Connecting to a Computer

**Before connecting, be sure to unplug the power cord of the projector from the AC outlet and turn off the devices to be connected. After making all connections, turn on the projector and then the other devices. When connecting a computer, be sure that it is the last device to be turned on after all the connections are made.**

Be sure to read the operation manuals of the devices to be connected before making connections.

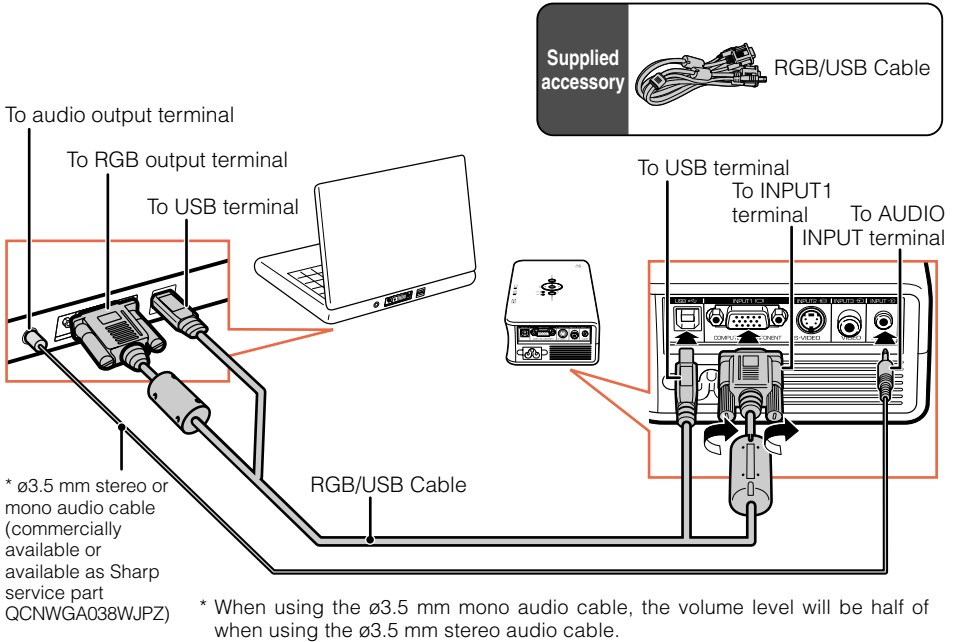

## Note

- When connecting with USB cable, you can use the remote control as a mouse for controlling cursor. See page 33.
- See page 59 "Computer Compatibility Chart" for a list of computer signals compatible with the projector. Use with computer signals other than those listed may cause some of the functions to not work.
- A Macintosh adaptor may be required for use with some Macintosh computers. Contact your nearest Macintosh Dealer.
- **Depending on the computer you are using, an image may not be projected unless the signal output setting of the computer is switched to the external output.** Refer to the computer operation manual for switching the computer signal output settings.

## "Plug and Play" function (when connecting to a 15-pin terminal)

- This projector is compatible with VESA-standard DDC 1/DDC 2B. The projector and a VESA DDC compatible computer will communicate their setting requirements, allowing for quick and easy setup.
- Before using the "Plug and Play" function, **be sure to turn on the projector first and the connected computer last.**

## Note

- The DDC "Plug and Play" function of this projector operates only when used in conjunction with a VESA DDC compatible computer.

# Connecting to Video Equipment

The projector has a COMPUTER/COMPONENT terminal, an S-VIDEO terminal and a VIDEO terminal for video input. See the illustration below to connect with the audio-visual equipment. The image quality is highest in order of the component signal, the S-video signal and the video signal. If your audio-visual equipment has a component output terminal, use the COMPUTER/COMPONENT terminal (INPUT1) on the projector for video connection.

## When using a 3 RCA (Component) to 15-pin D-sub cable

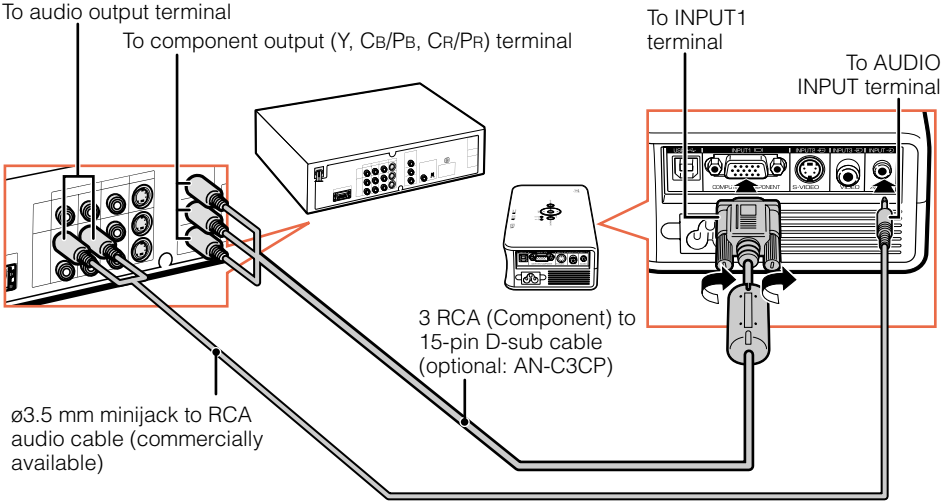

## When using an S-video cable

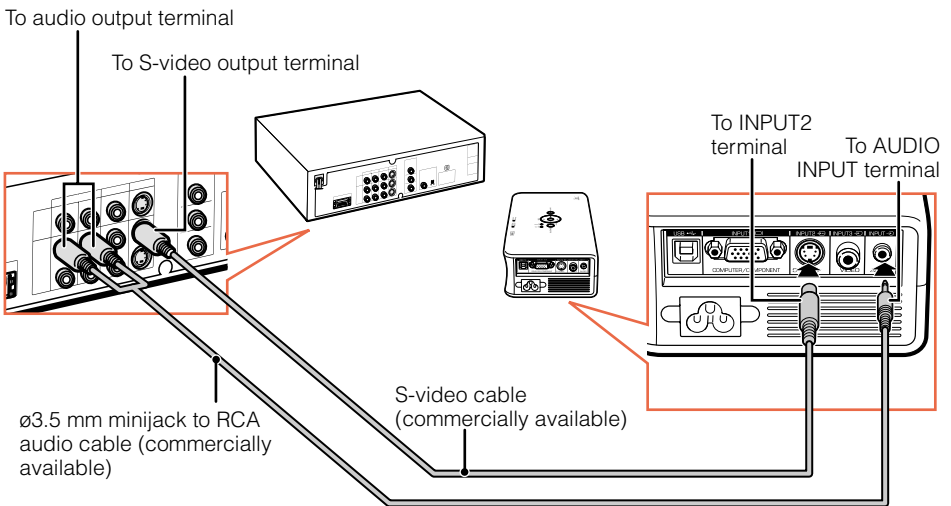

## When using a composite video cable

To audio output terminal

To video output terminal

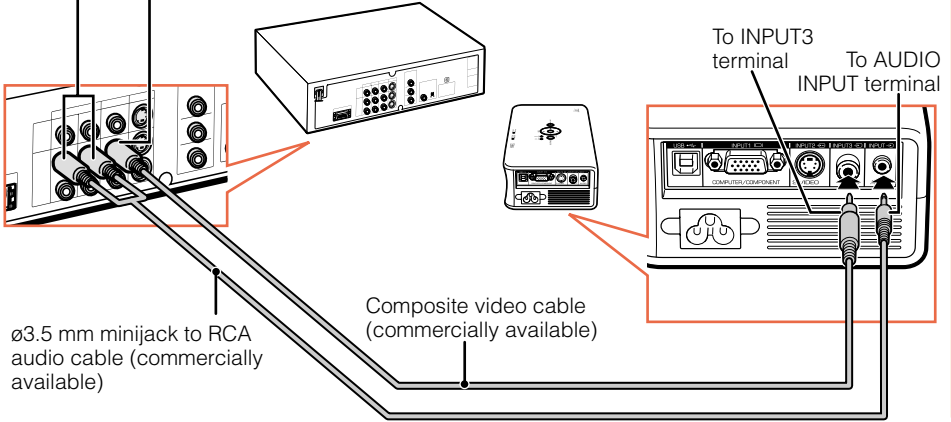

### Note

- ø3.5 mm minijack to RCA audio cable (commercially available) is required for audio input.

## Connecting the Power Cord

Plug the supplied power cord into the AC socket on the side of the projector.

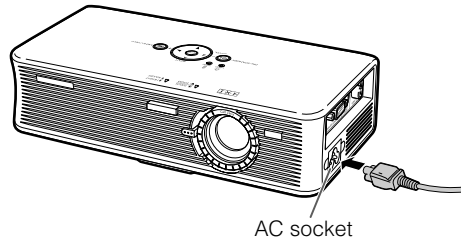

# Turning the Projector On/Off

## Turning the Projector on

Before performing the steps in this section, connect any equipment that you use with the projector. (See pages 23, 24 and 25.) Also connect the power cord to the projector. (See page 25.)

Press **ON/STANDBY** on the projector or **ON/STANDBY** on the remote control.

- When turning on the projector, you will hear the system sound. (When "System Sound" is set to "On". → page 50)
- When the lamp is warming up, the Adjustment buttons blink in a clockwise direction. (When "Guide LEDs" is set to "On". → page 48)
- After the projector turns on, the Setup Guide screen appears. (When "Setup Guide" is set to "On". → page 45)
- When System Lock is set, the keycode input box appears. Enter the right keycode to start projection. See page 49 for details.

### Note

#### About the Lamp Indicator

- The lamp indicator lights up or blinks, indicating the status of the lamp.
  - Green:** The lamp is ready.
  - Blinking in green:** The lamp is warming up or shutting down.
  - Red:** The lamp is shut down abnormally or the lamp should be replaced.
- If the projector is put into the standby mode and immediately turned on again, the lamp may take some time to start projection.

### Info

- English is the factory default language. If you want to change the on-screen display to another language, change the language according to the procedure on page 46.

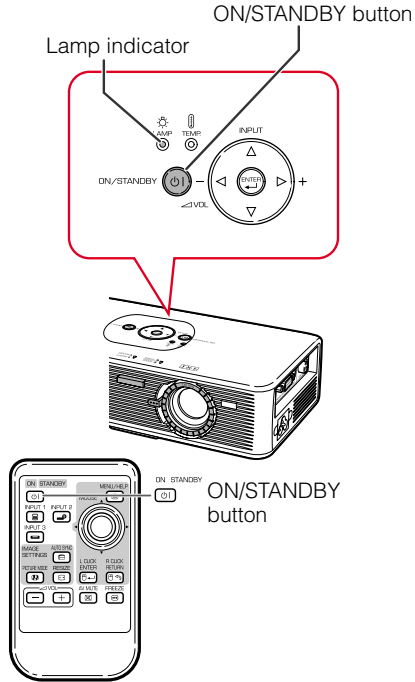

On-screen Display (confirmation message)

**ON/STANDBY** Enter STANDBY mode?  
Yes : Press Again  
No : Please Wait

Shutting Down. Please Wait.

### Info

- Do not unplug the power cord during projection or cooling fan operation. This can cause damage due to rise in internal temperature, as the cooling fan also stops.

## Turning the Power off (Putting the Projector into Standby Mode)

**1** Press **ON/STANDBY** on the projector or **ON/STANDBY** on the remote control, then press that button again while the confirmation message is displayed, to put the projector into standby mode.

**2** Unplug the power cord from the AC outlet after the cooling fan stops.

- When the projector is turned off, the Adjustment buttons blink in a counterclockwise direction. (When "Guide LEDs" is set to "On". → page 48)

# Image Projection

## About the Setup Guide

After turning on the projector, the Setup Guide screen appears to assist you with projector setup.

- Guidance items
- 1 FOCUS
  - 2 HEIGHT ADJUST
  - 3 ZOOM
  - 4 ENTER

Adjust the projector by following the illuminated buttons or Setup Guide indicators.

Press **ENTER** to turn off the Setup Guide screen.

### Note

- The Setup Guide screen automatically highlights the items in order of **1 FOCUS → 2 HEIGHT ADJUST → 3 ZOOM → 4 ENTER**.
- You can adjust the focus, height or zoom anytime you want, regardless of the selection on the Setup Guide.
- If you do not want to display the Setup Guide for the next time, set "Menu" - "SCR - ADJ" - "Setup Guide" to "Off". (See page 45.)

Setup Guide screen

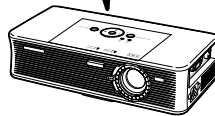
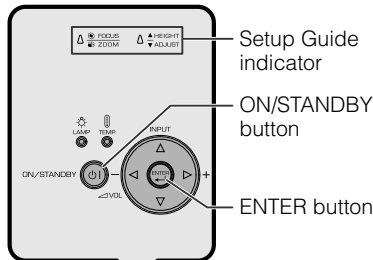
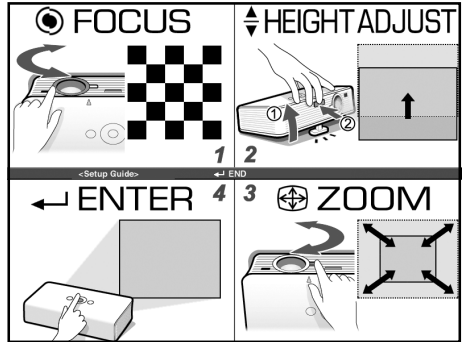

## Adjusting the Projected Image

### 1 Adjusting the Focus

You can adjust the focus with the focus ring on the projector.

Rotate the focus ring to adjust the focus while watching the projected image.

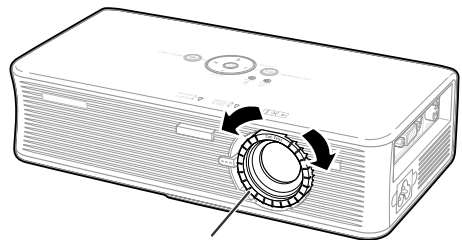

Focus ring

# Image Projection (Continued)

## 2 Adjusting the Height

The height of the projector can be adjusted using the adjustment feet at the front and rear of the projector.

When the screen is in a higher position than the projector, the projection image can be made higher by adjusting the projector.

**1** Lift the projector to adjust its height while pressing the HEIGHT ADJUST button.

**2** Remove your hands from the HEIGHT ADJUST button of the projector after its height has been finely adjusted.

- The angle of projection is adjustable up to 7.5 degrees from the surface on which the projector is placed.

**3** Use the rear adjustment foot to make the projector level.

- The projector is adjustable  $\pm 1$  degree from the standard position.

### Note

- When adjusting the height of the projector, trapezoidal distortion occurs. When "Auto Keystone" is set to "On", keystone correction functions automatically to correct trapezoidal distortion. When you want to adjust the automatically corrected image, use the manual keystone correction. (See page 44.)

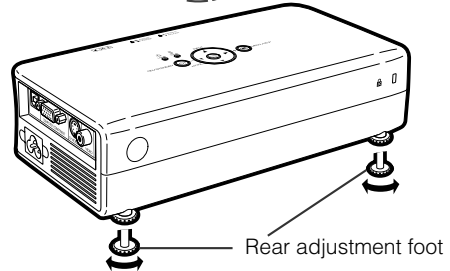
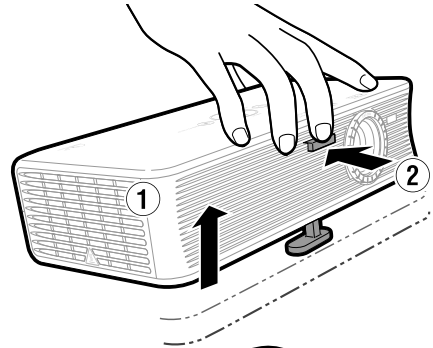
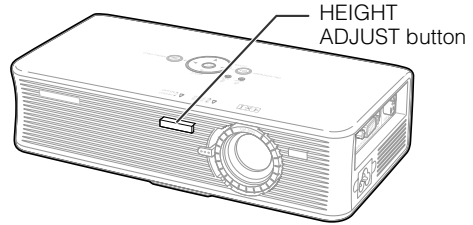

### Info

- Do not apply too much pressure on the projector when the front adjustment foot comes out.
- When lowering the projector, be careful not to get your fingers caught in the area between the adjustment foot and the projector.

## 3 Adjusting the Screen Size

You can adjust the screen size using the zoom knob on the projector.

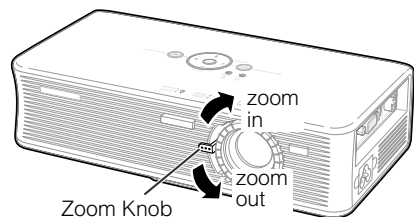



## Switching the Input Mode

Select the appropriate input mode for the connected equipment.

Press **INPUT 1**, **INPUT 2** or **INPUT 3** on the remote control to select the input mode.

- When pressing INPUT ( $\Delta/\nabla$ ) on the projector, input mode switches in order of .
- When "Auto Search" is set to "On", INPUT ( $\Delta/\nabla$ ) on the projector functions as the Auto Search buttons. (See page 47.)

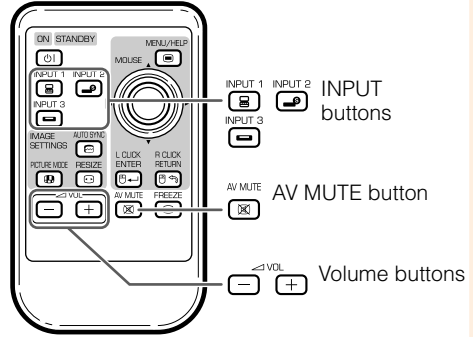

## Adjusting the Volume

Press / on the remote control or  $\triangleleft/\triangleright$  on the projector to adjust the volume.

### Note

- Pressing / $\triangleleft$  will lower the volume.
- Pressing / $\triangleright$  will raise the volume.

## Displaying the Black Screen and Turning off the Sound Temporarily

Press **AV MUTE** on the remote control to temporarily display a black screen and turn off the sound.

### Note

- Pressing AV MUTE again will turn the projected image back on.

On-screen Display



On-screen Display



# Image Projection (Continued)

## Resize Mode

This function allows you to modify or customize the resize mode to enhance the input image. Depending on the input signal, you can choose “NORMAL”, “BORDER” or “STRETCH” image.

Press  **RESIZE**.

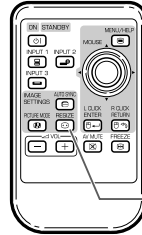

- See page 43 for setting on menu screen.



 RESIZE button

### Computer

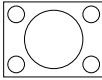
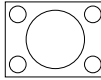
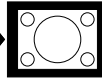
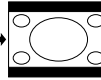
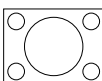
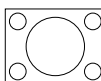
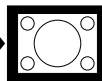
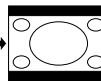
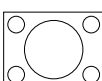
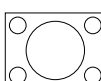
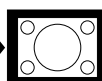
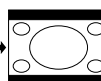
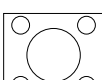
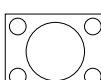
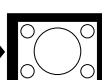
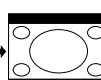
		NORMAL	BORDER	STRETCH
4:3 aspect ratio	SVGA (800 × 600)	800 × 600	600 × 450	800 × 450
	XGA (1024 × 768)			
	SXGA (1280 × 960)			
	SXGA + (1400 × 1050)			
Other aspect ratios	SXGA (1280 × 1024)	—	—	800 × 450
	1280 × 720			





Input Signal		Output screen image		
Computer	Image type	NORMAL Projects a full screen image while maintaining the aspect ratio.	BORDER Projects 4:3 image fully in STRETCH (the following column) image.	STRETCH Projects 16:9 image evenly over entire screen (top/bottom blank bands).
Resolution lower than SVGA	 4:3 aspect ratio			
SVGA	 4:3 aspect ratio			
Resolution higher than SVGA	 4:3 aspect ratio			
SXGA (1280 × 1024)	 5:4 aspect ratio			
1280 × 720	 16:9 aspect ratio	—	—	

\* Mode for projecting an image with the original aspect ratio without cutting any portions.

 : Cutout area on which images cannot be projected.

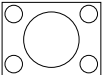
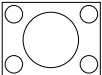
# VIDEO

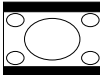
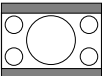
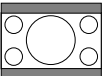
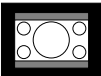
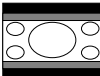
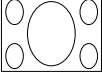
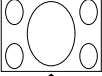
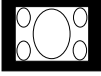
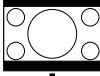
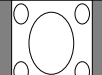
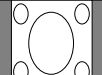
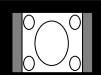
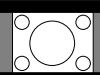
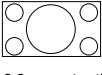
- “STRETCH” is fixed when 540P, 720P or 1080I signals are entered.

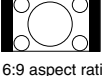
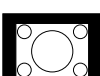
Input Signal		Output screen image		
		NORMAL Projects a full screen image.	BORDER Projects 4:3 image fully in STRETCH (the following column) image.	STRETCH Projects 16:9 image evenly over entire screen (top/bottom black bands).
DVD / Video	Image type			
480I, 480P, NTSC, PAL, SECAM	 4:3 aspect ratio	* 	* 	
	 Letter box	* 	* 	
	 Squeezed 16:9 image			* 
	 Squeezed 4:3 image			* 
540P, 720P, 1080I (16:9)	 16:9 aspect ratio	—	—	* 
	 16:9 aspect ratio (4:3 aspect ratio in 16:9 screen)	—	—	* 

\* Mode for projecting an image with the original aspect ratio without cutting any portions.

: Cutout area on which images cannot be projected.

: Area on which the image is not included in the original signals.

# Adjusting/Operating with the Remote Control

## Auto Sync (Auto Sync Adjustment)

Auto Sync function works when detecting input signal after the projector turns on.

Press  AUTO SYNC to manually adjust with Auto Sync function.

### Note

- When the optimum image cannot be achieved with Auto Sync adjustment, use the help menu for manual adjustments. (See page 51.)

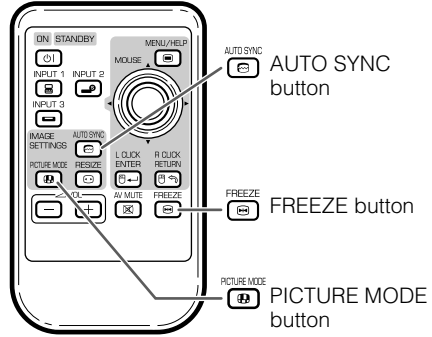

## Freezing a Moving Image

**1** Press  FREEZE.





- The projected image is frozen.

**2** Press  FREEZE again to return to the moving image from the currently connected device.

## Selecting the Picture Mode

You can select the suitable picture mode for the projected image, such as movie or video game.

Press  PICTURE MODE.

- When pressing  PICTURE MODE, the picture mode changes in order of  Standard  Presentation  Cinema  Game.

### Note

- See page 40 for details on the picture mode.

## Using Mouse Function

When connecting the projector and computer with the USB terminals, you can use the remote control as the computer mouse.

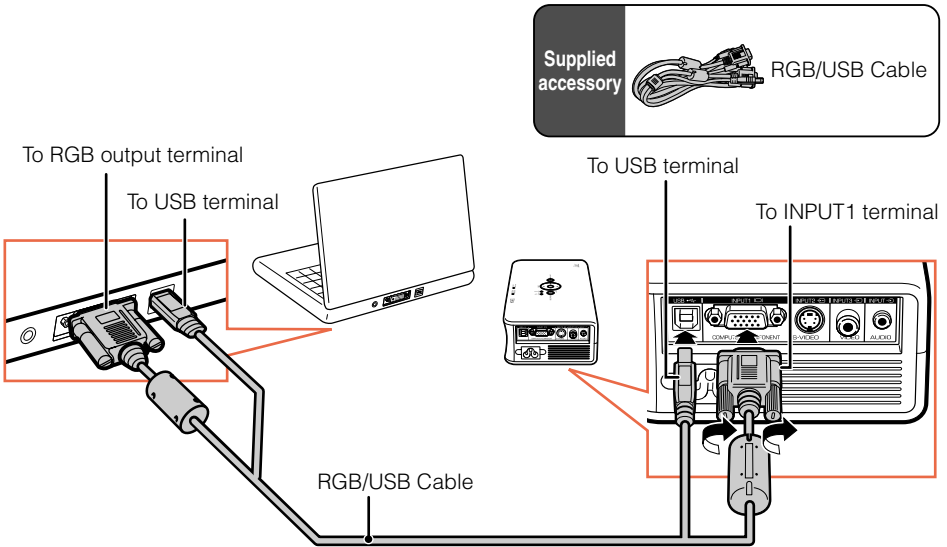

**1** Connect the projector and the computer with the supplied RGB/USB cable.

**2** Use the mouse functions.

- MOUSE/Adjustment button (▲/▼/◀/▶) functions to move cursor.
- L CLICK button functions as the left click.
- R CLICK button functions as the right click.
- L CLICK and R CLICK have common function when your computer supports only a one-click mouse, such as Macintosh.

### Note

- you can not use this function when displaying the menu screen.

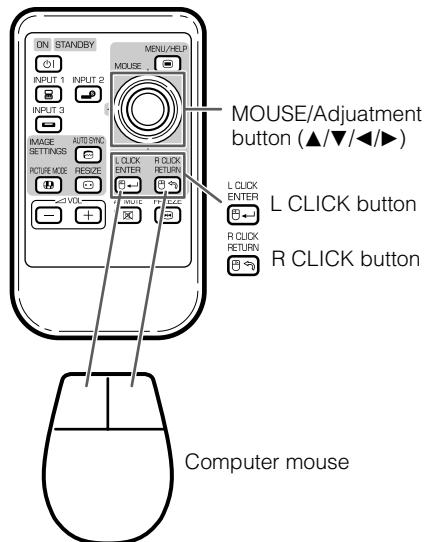

# Menu Items

The following shows the items that can be set in the projector.

## “Picture” menu

### INPUT 1 (RGB)

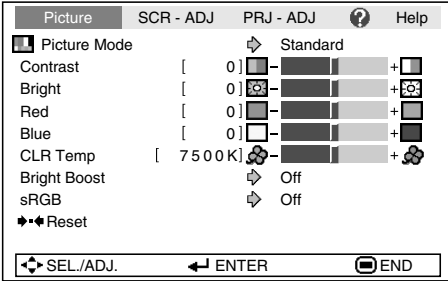

### INPUT 1 (Component)/INPUT 2/INPUT 3

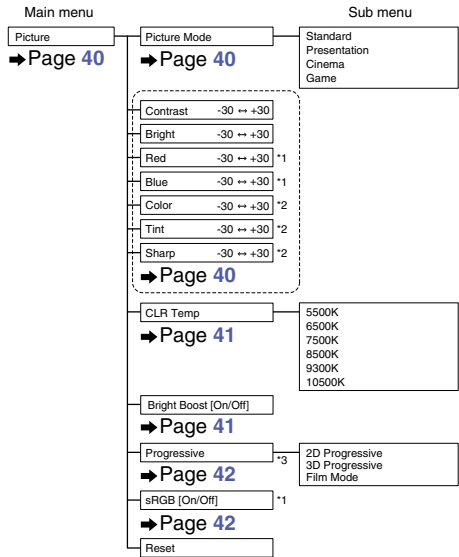
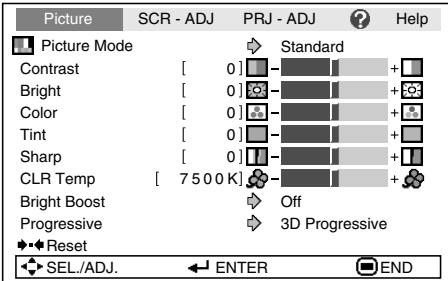

\*1 Items when inputting RGB signal through INPUT 1

\*2 Items when inputting component signal through INPUT 1, or when selecting INPUT 2 or INPUT 3

\*3 Items when selecting INPUT 2 or INPUT 3

## “SCR - ADJ” menu

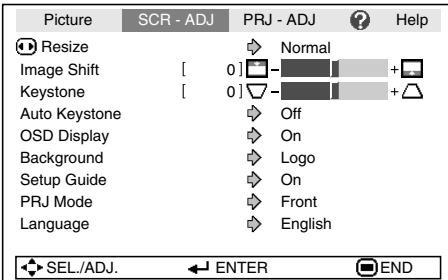

- You can adjust the menu items with icons (Image Shift) and (Keystone) using the respective buttons on the remote control.

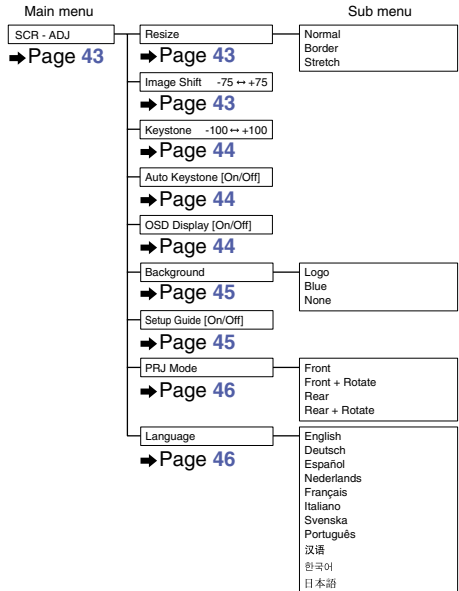

## “PRJ - ADJ” menu

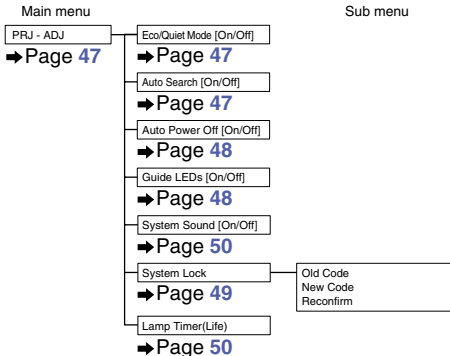
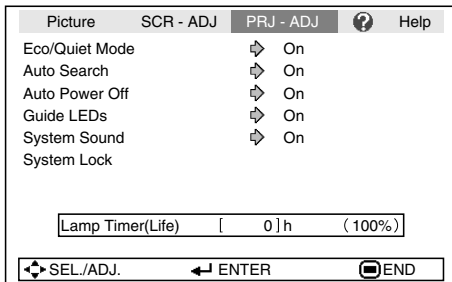

## “Help” menu

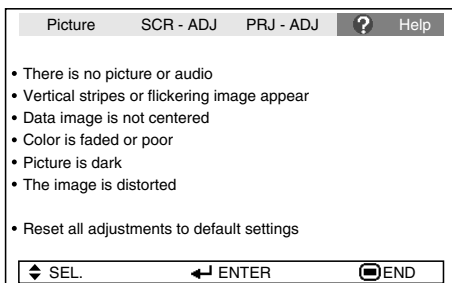

## The items you can set with “Help” menu

### “Help” menu → Page 51

- Vertical stripes or flickering image appear
  - Auto Sync
  - Adjust vertical noise
  - Adjust horizontal noise
- Data image is not centered
  - Auto Sync
  - H-Pos
  - V-Pos
- Color is faded or poor
  - INPUT 1
    - Signal type: Auto/RGB/Component
  - INPUT 2 or INPUT 3
    - Video System: A u t o / P A L / S E C A M / NTSC3.58/NTSC4.43/PAL-M/PAL-N/PAL-60

\* The selectable items vary depending on the input signal and the selected input mode.

# Using the Menu Screen

The menu can be operated to achieve two functions, adjustment and setting. (For setting the menu items, see pages 38 and 39.)

## Operating with the projector

When “PRJ - ADJ” - “Guide LEDs” is set to “On”, the buttons used for menu adjustment on the projector light up.

Example: When  $\Delta$ ,  $\nabla$  and the MENU/HELP button light up on the projector, you can use those buttons for operation.

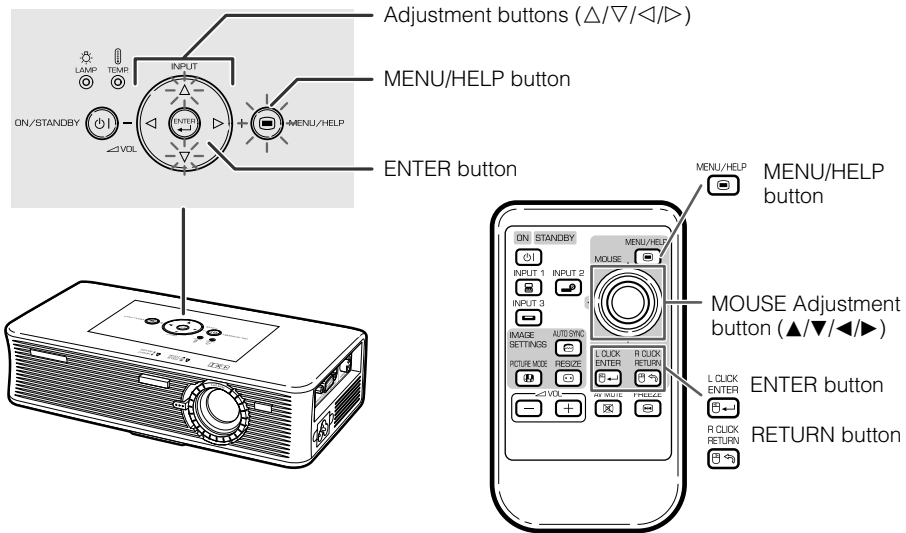

## Menu Selections (Adjustments)

Example: Adjusting “Bright”.

- This operation can also be performed by using the buttons on the projector.

**1** Press **MENU**.  
 • The “Picture” menu screen for the selected input mode is displayed.

**2** Press **▶** or **◀** to display the other menu screen.  
 • The selected menu item is highlighted.

Example: “Picture” screen menu for INPUT 1 (RGB) mode

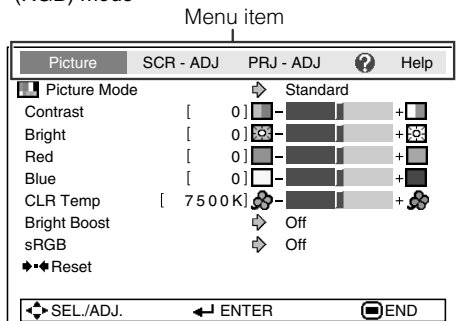



### 3 Press ▲ or ▼ to select the item you want to adjust.

- The selected item is highlighted.

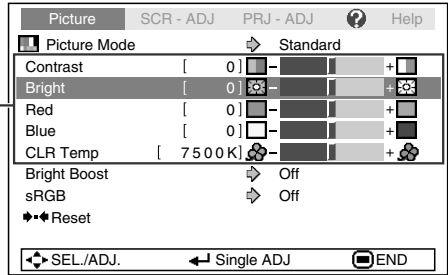

Single adjustment items

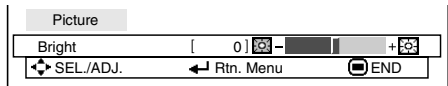
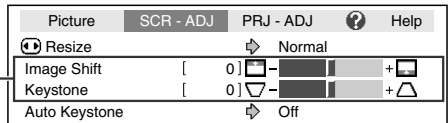

## To adjust the projected image while watching it

### Press ENTER.

- The selected single adjustment item (e.g. "Bright") appears instead of the menu.
- When pressing ▲ or ▼, the following item ("Red" after "Bright") will be displayed.

#### Note

- Press ENTER to return to the previous screen.

### 4 Press ◀ or ▶ to adjust the item selected.

- The adjustment is stored.

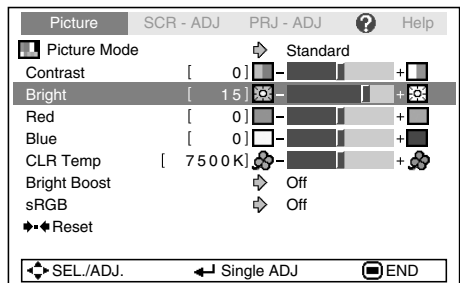

### 5 Press MENU.

- The menu screen will disappear.

#### Note

- Press RETURN to return to the previous screen when the menu is displayed.

# Using the Menu Screen (Continued)

The menu can be operated to achieve two functions, adjustment and setting. (For adjusting the menu items, see pages 36 and 37.)

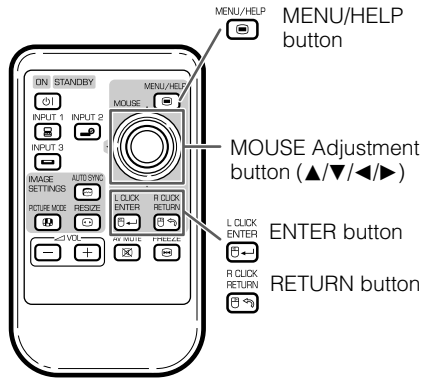

## Menu Selections (Settings)

Example: Setting "Background".

- This operation can also be performed by using the buttons on the projector.

### 1 Press MENU.

- The "Picture" menu screen for the selected input mode is displayed.

### 2 Press or to display the other menu screen.

- The selected menu item is highlighted.

Example: "Picture" screen menu for INPUT 1 (RGB) mode

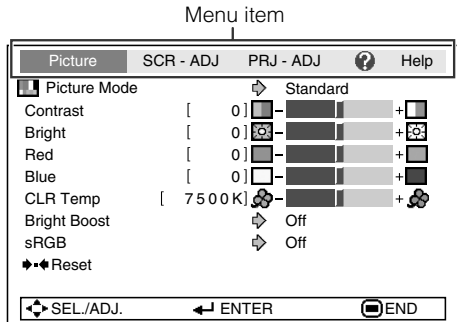

**3** Press ▲ or ▼ to select the item you want to set, and then press **ENTER** or ► to display the sub menu.

- The selected item is highlighted.

**Note**

- Press **RETURN** or ◀ to return to the previous screen.

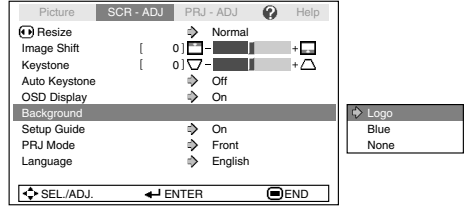

**4** Press ▲ or ▼ select the setting of the item displayed in the sub menu.

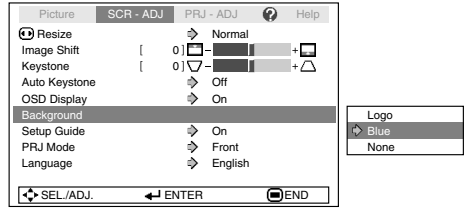

**5** Press **ENTER**.

**6** Press **MENU**.

- The menu screen will disappear.

# Picture Adjustment (“Picture” menu)

You can adjust the projector’s picture to your preferences using the “Picture” menu.

## Selecting the Picture mode

Menu operation → Page 38

- ▶ Example: “Picture” screen menu for INPUT 1 (RGB) mode

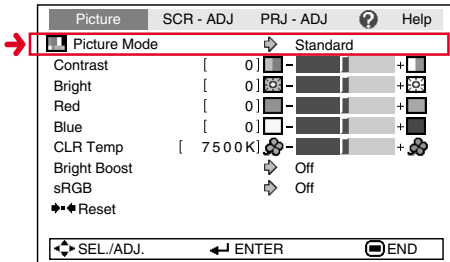

### Description of Items

Selectable items	Description
Standard	For standard image
Presentation	Brightens darker portions of image for more enhanced presentations.
Cinema	Gives greater depth to darker portions of image for a more exciting theater experience.
Game	For natural color gradation for playing a game, etc.

#### Note

- You can also press PICTURE MODE on the remote control to select the picture mode. (See page 32.)

## Adjusting the Image

Menu operation → Page 36

- ▶ Example: “Picture” screen menu for INPUT 1 (RGB) mode

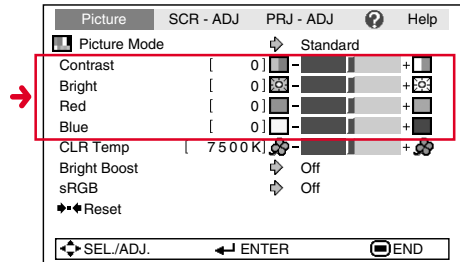

### Description of Adjustment Items

Adjustment Items	◀ button	▶ button
Contrast	For less contrast.	For more contrast.
Bright	For less brightness.	For more brightness.
Red*1	For weaker red.	For stronger red.
Blue*1	For weaker blue.	For stronger blue.
Color*2	For less color intensity.	For more color intensity.
Tint*2	For making skin tones purplish.	For making skin tones greenish.
Sharp*2	For less sharpness.	For more sharpness.

\*1 Not adjustable/selectable when you set “sRGB” menu item to “On”, or the input signal is component.

\*2 Not displayed in the RGB input mode.

#### Note

- To reset all adjustment items, select “Reset” and press ENTER.

## Adjusting the Color Temperature

Menu operation → Page 36

▶ Example: “Picture” screen menu for INPUT 1 (RGB) mode

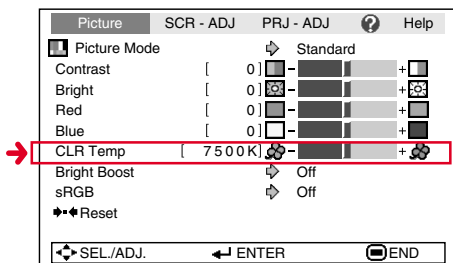

### Note

- Values on “CLR Temp” are only for general standard purposes.
- “CLR Temp” cannot be set when “sRGB” is set to “On”.

### Description of Items

Selectable items	Description
5500K	
6500K	
7500K	
8500K	
9300K	
10500K	For higher color temperature for cooler, bluish, fluorescent-like images.

## Emphasizing the Contrast

This function emphasizes the bright portions of images to obtain a higher contrast image.

Menu operation → Page 38

▶ Example: “Picture” screen menu for INPUT 1 (RGB) mode

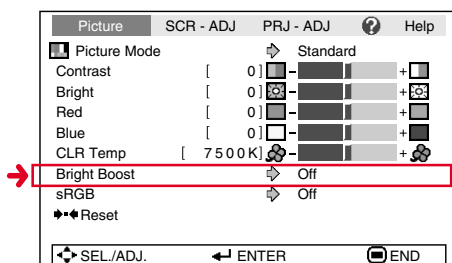

### Note

- When using this function, the image color may become pale or the tint may be inappropriate.
- “Bright Boost” cannot be set when “sRGB” is set to “On”.

# Picture Adjustment (“Picture” menu) (Continued)

## Progressive

Menu operation → Page 38

▶ Example: “Picture” screen menu for INPUT 2 mode

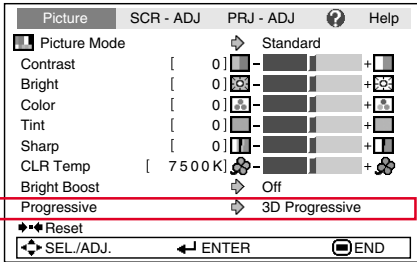

Description of Items

Selectable items	Description
2D Progressive	Useful to display fast-moving images such as sports and action films.
3D Progressive	Useful to display relatively slow-moving images such as drama and documentary more clearly.
Film Mode	Reproduces the image of film source* clearly. Displays the optimized image of film transformed with three-two pull down (NTSC and PAL60Hz) or two-two pull down (PAL50Hz and SECAM) enhancement to progressive mode images.

\* The film source is a digital video recording with the original encoded as is at 24 frames/second. The projector can convert this film source to progressive video at 60 frames/second with NTSC and PAL60Hz or at 50 frames/second with PAL50Hz and SECAM to play back a high-definition image.

### Note

- In NTSC or PAL60Hz, even if the 3D Progressive mode has been set, the three-two pull down enhancement will be enabled automatically when the film source has been entered.
- When the image is blurred or noisy, switch to the optimal mode.
- When using progressive inputs, inputs are directly displayed so that 2D Progressive, 3D Progressive and Film Mode cannot be selected.

## sRGB Setting

Menu operation → Page 38

▶ Example: “Picture” screen menu for INPUT 1 (RGB) mode

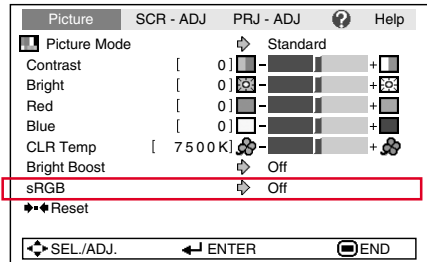

### Note

- An international standard of color reproduction regulated by the IEC (International Electrotechnical Commission). As the fixed color area has been decided by the IEC, the images are displayed in a natural tint based on an original image, when “sRGB” is set to “ON”.
- For additional information about the sRGB function, visit “<http://www.srgb.com/>”.
- You cannot set the items, “Red”, “Blue”, “CLR Temp”, “Bright Boost”, when “sRGB” is set to “On”.

### Info

- When “sRGB” is set to “On”, the projected image may become dark, but this does not indicate a malfunction.

# Adjusting the Projected Image (“SCR - ADJ” menu)

You can adjust the projected image and on-screen display to your preferences using the “SCR - ADJ” menu.

## Setting the Resize Mode

Menu operation → Page 38

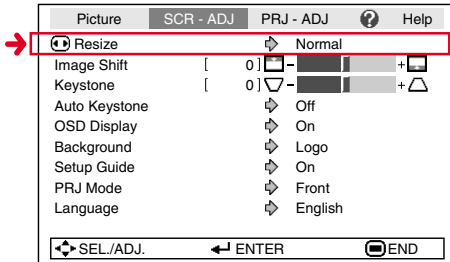

### Note

- For details of the Resize mode, see pages 30 and 31.
- You can also press **RESIZE** on the remote control to set the resize mode. (See page 30.)

## Adjusting the Image Position

You can move the projected image vertically.

Menu operation → Page 36

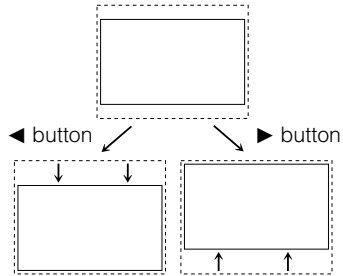
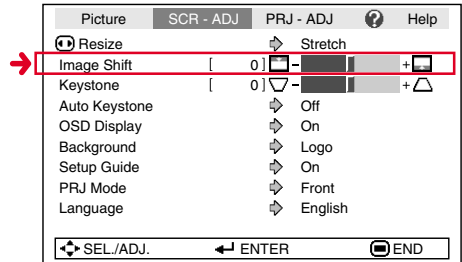

### Note

- You cannot set this item when “Resize” is set to “Normal”.
- To reset this function, select “0”.
- When adjusting the image shift, “Keystone” is set to “0” and “Auto Keystone” is set to “Off”.

# Adjusting the Projected Image (“SCR - ADJ” menu) (Continued)

## Keystone Correction

When the image is projected either from the top or from the bottom towards the screen at an angle, the image becomes distorted trapezoidally. The function for correcting trapezoidal distortion is called Keystone Correction.

Auto Keystone Correction

**Set “Auto Keystone” on the “SCR - ADJ” menu to “On”.**

Menu operation → Page 38

Manual Keystone Correction

**Set “Auto Keystone” on the “SCR - ADJ” menu to “Off”, and select “Keystone”, then adjust with the slide bar.**

Menu operation → Page 36

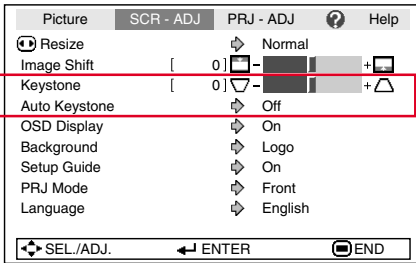

## Setting On-screen Display

This function allows you to turn the on-screen messages on or off.

Menu operation → Page 38

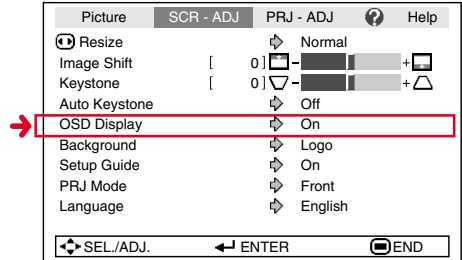

Description of Items

Selectable items	Description
On	All On-screen Displays are displayed.
Off	INPUT/VOLUME/AV MUTE/FREEZE/AUTO SYNC/RESIZE/PICTURE MODE/“An invalid button has been pressed.” are not displayed.

## Manual Correction

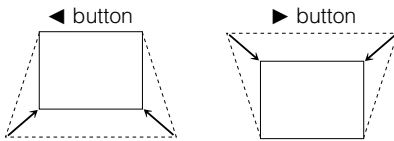

### Note

- The Keystone Correction can be adjusted up to an angle of approximately  $\pm 13$  degrees with the “Auto Keystone” and up to an angle of approximately  $\pm 15$  degrees with the manual “Keystone”. (when “Resize” is set to “Normal”)
- When the screen is slanting or the image is deteriorated, set “Auto Keystone” to “Off”.
- When adjusting the keystone or when “Auto Keystone” is set to “On”, “Image Shift” is automatically set to “0”.



## Selecting the Background Image

Menu operation → Page 38

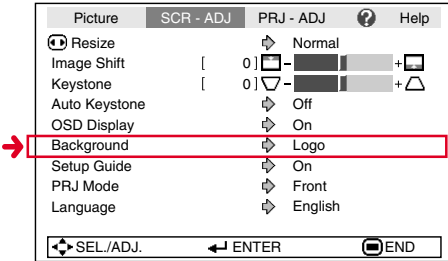

Description of Items

Selectable items	Description
Logo	Sharp logo screen
Blue	Blue screen
None	—

## Setting the Setup Guide

You can set the Setup Guide screen during the projector startup.

Menu operation → Page 38

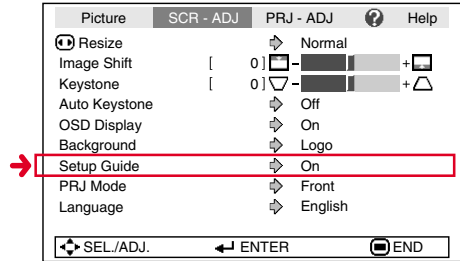

Description of Items

Selectable items	Description
On	Displaying the Setup Guide when turning the projector on.
Off	Not displaying the Setup Guide.

# Adjusting the Projected Image (“SCR - ADJ” menu) (Continued)

## Reversing/Inverting Projected Images

Menu operation → Page 38

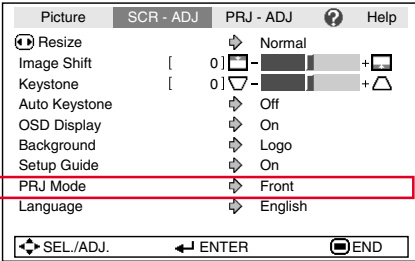

Description of Items

Selectable items	Description
Front	Projecting from the front of the screen
Front + Rotate	Projecting with a mirror
Rear	Projecting from the rear of the screen or with a mirror
Rear + Rotate	Projecting with a mirror

## Selecting the On-screen Display Language

The projector can switch the on-screen display language among 11 languages.

Menu operation → Page 38

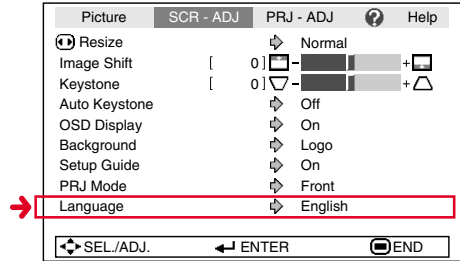

Selectable items

- English
- Deutsch
- Español
- Nederlands
- Français
- Italiano
- Svenska
- Português
- 汉语
- 한국어
- 日本語

# Setting the Projector Function (“PRJ - ADJ” menu)

You can use the “PRJ - ADJ” menu to enhance the usage for the projector.

## Eco/Quiet Mode

Menu operation → Page 38

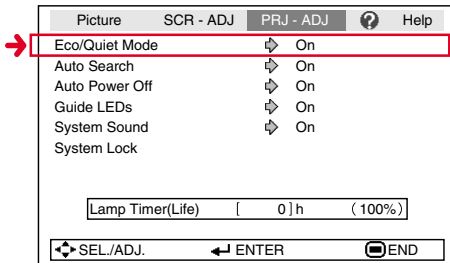

### Note

- This function is factory preset to “Off”.
- When “Eco/Quiet Mode” is set to “On”, the power consumption will decrease and the lamp life will extend. (Projection brightness decreases 10%.)

### Description of items

Selectable items	Brightness	Fan sound	Power consumption (When using AC 100V)	Lamp Life
On	Approx. 90%	Low	177W	Approx. 4,000 hours
Off	100%	Standard	195W	Approx. 3,000 hours

## Auto Search Function

This function automatically searches for and switches to the input mode in which signals are being received, when the projector is turned on, or when the INPUT button is pressed.

Menu operation → Page 38

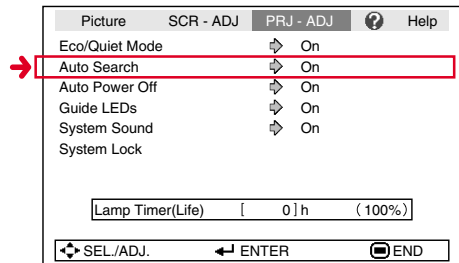

### Note

#### When “Auto Search” is set to “On”

- The projector automatically selects the available input source.
- If two or more input signals are found, the projector selects the input source in the order of INPUT 1 → INPUT 2 → INPUT 3 when you press INPUT ( $\Delta/\nabla$ ) on the projector.
- While “Auto Search” is set to “On”, press  $\square$  INPUT 1,  $\square$  INPUT 2 or  $\square$  INPUT 3 on the remote control to select an input mode other than the input mode selected by the projector.
- When “Auto Search” is set to “Off”, input mode switches in order of  $\square$  INPUT1 $\leftrightarrow$ INPUT2 $\leftrightarrow$ INPUT3 $\leftarrow$  by pressing INPUT ( $\Delta/\nabla$ ) on the projector.

# Setting the Projector Function (“PRJ - ADJ” menu) (Continued)

## Auto Power Off Function

Menu operation → Page 38

Picture	SCR - ADJ	PRJ - ADJ	?	Help
Eco/Quiet Mode		↕ On		
Auto Search		↕ On		
Auto Power Off		↕ On		
Guide LEDs		↕ On		
System Sound		↕ On		
System Lock				

Lamp Timer(Life) [ 0 ]h (100%)

◀SEL./ADJ.    ↩ENTER    ▶END

Description of items

Selectable items	Description
On	When no input signal is detected for more than 15 minutes, the projector will automatically enter the standby mode.
Off	The Auto Power Off function will be disabled.

### Note

- When the Auto Power Off function is set to “On”, 5 minutes before the projector enters standby mode, the message “Enter STANDBY mode in X min.” will appear on the screen to indicate the remaining minutes.

## Setting the Guide LEDs

Menu operation → Page 38

Picture	SCR - ADJ	PRJ - ADJ	?	Help
Eco/Quiet Mode		↕ On		
Auto Search		↕ On		
Auto Power Off		↕ On		
Guide LEDs		↕ On		
System Sound		↕ On		
System Lock				

Lamp Timer(Life) [ 0 ]h (100%)

◀SEL./ADJ.    ↩ENTER    ▶END

Description of items

Selectable items	Description
On	The indicators for operation guidance and the buttons for operation light up.
Off	No indicators or buttons for operation guidance blinks or lights up.

## System Lock Function

This function prevents unauthorized use of the projector. Once this function is activated, users must enter the correct keycode each time the projector is turned on. **We suggest you record the keycode in a safe place where only authorized users have access.**

### Info

- If you lose or forget your keycode, contact your nearest Sharp Authorized Projector Dealer or Service Center (see page 62). Even if the product warranty is valid, the keycode reset will incur a charge.

Menu operation → Page 38

Picture	SCR - ADJ	PRJ - ADJ	?	Help
Eco/Quiet Mode		↔	On	
Auto Search		↔	On	
Auto Power Off		↔	On	
Guide LEDs		↔	On	
System Sound		↔	On	
 System Lock				

## Setting/Changing the keycode

**1 Press the 4 buttons on the remote control or on the projector to enter the preset keycode in “Old Code”.**

- When setting the keycode for the first time, press  $\nabla$  on the projector for four times.





PRJ - ADJ	
Setting the System Lock	
Old Code	— — — —
New Code	— — — —
Reconfirm	— — — —

### Note

- If you input a wrong keycode, the cursor returns to the first point of the “Old Code”.
- The preset keycode is 4  $\nabla$  buttons on the projector. When this keycode is set, the keycode input screen does not appear.

**2 Press the 4 buttons on the remote control or on the projector to enter the new keycode in “New code”.**

### Note

- You can not use the following buttons for keycode:
  -  ON/STANDBY
  -  ENTER
  -  RETURN
  -  MENU/HELP
- **System lock function recognizes each button on the remote control or on the projector as an individual button, even if they share the same button name. If you set the keycode with the buttons on the projector, use only those buttons on the projector. If you set the keycode with the buttons on the remote control, use only those buttons on the remote control.**

PRJ - ADJ	
Setting the System Lock	
Old Code	* * * *
New Code	— — — —
Reconfirm	— — — —

**3 Enter the same keycode in “Reconfirm”.**

### Note

Not displaying the keycode input screen when turning the projector on

- Press  $\nabla$  on the projector for four times in steps 2 and 3 above.

**When the System Lock is set**

- When System Lock is set, the keycode input screen appears after the power is turned on. When it appears, enter the right keycode to start projection.

Input screen for keycode

System Lock	— — — —
-------------	---------

# Setting the Projector Function (“PRJ - ADJ” menu) (Continued)

## Setting the Confirmation Sound

Menu operation → Page 38

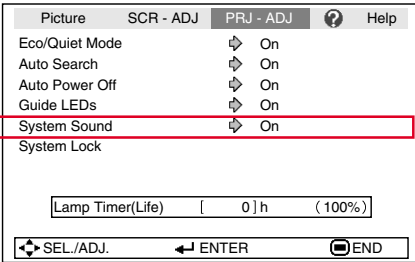

### Description of items

Selectable items	Description
On	A confirmation sound is made when the projector turns on/off.
Off	No confirmation sound is made.

## Checking the Lamp Life Status

You can confirm the cumulative lamp usage time and the remaining lamp life (percentage).

Menu operation → Page 36

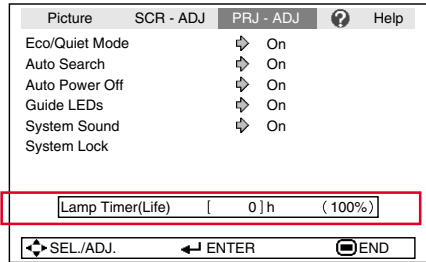

### Description of Lamp Life

Lamp usage condition	Remaining lamp life	
	“Life”	
	100%	5%
Operated exclusively in Eco/Quiet Mode “On”	Approx. 4,000 hours	Approx. 200 hours
Operated exclusively in Eco/Quiet Mode “Off”	Approx. 3,000 hours	Approx. 150 hours

### Note

- It is recommended that the lamp be changed when the remaining lamp life becomes 5%. For lamp replacement, contact your nearest Sharp Authorized Projector Dealer or Service Center.
- The lamp life may vary depending on the usage condition.

# Troubleshooting with “Help” menu

This function advises you to solve the problems during usage.

## Displaying “Help” menu screen

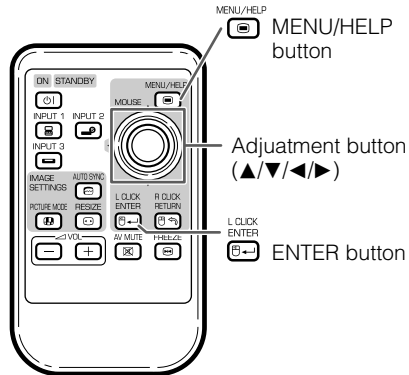

Example: When image flickering appears

Operation to solve image flickering when projecting the computer RGB signal.

**1** Press MENU/HELP.

**2** Press or to select “Help”, then press ENTER.

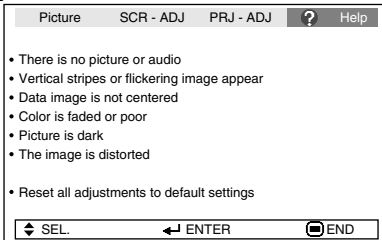

**3** Press or to select “Vertical stripes or flickering image appears” on Help menu, then press ENTER.

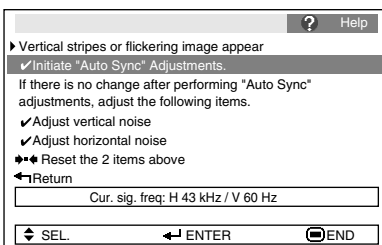

**4** Select “Initiate “Auto Sync” Adjustments”, then press ENTER.

**5** If the image is not improved, select “Adjust horizontal noise.”, then press ENTER.

**6** Press or to adjust.

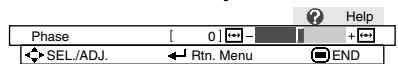

### Note

- You can adjust the items with check marks (✓).
- Some items in the Help menu may not appear, depending on the projected image.
- If the problem is not solved, refer to “Troubleshooting”. (see pages 60 and 61)

# Maintenance

## Cleaning the projector

- Be sure to unplug the power cord before cleaning the projector.
- The cabinet as well as the operation panel is made of plastic. Avoid using benzene or thinner, as these can damage the finish on the cabinet.
- Do not use volatile agents such as insecticides on the projector.  
Do not attach rubber or plastic items to the projector for long periods.  
The effects of some of the agents in the plastic may cause damage to the quality or finish of the projector.

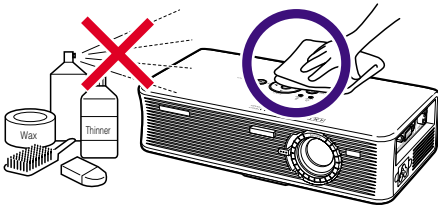
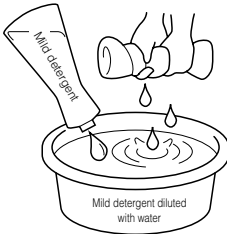

- Wipe off dirt gently with a soft flannel cloth.
- When the dirt is hard to remove, soak a cloth in a mild detergent diluted with water, wring the cloth well and then wipe the projector. Strong cleaning detergents may discolor, warp or damage the coating on the projector. Make sure to test on a small, inconspicuous area on the projector before use.

## Cleaning the lens

- Use a commercially available blower or lens cleaning paper (for glasses and camera lenses) for cleaning the lens. Do not use any liquid type cleaning agents, as they may wear off the coating film on the surface of the lens.
- As the surface of the lens can easily get damaged, be sure not to scrape or hit the lens.

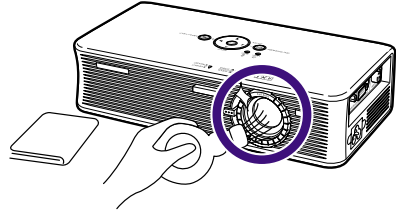

## Cleaning the exhaust and intake vents

- Use a vacuum cleaner to clean dust from the exhaust vent and the intake vent.

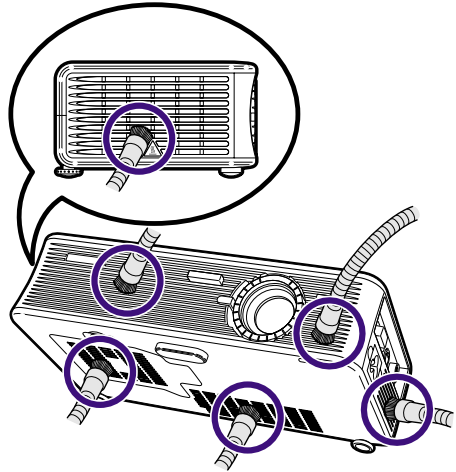



# Maintenance Indicators

- The warning lights (ON/STANDBY button, lamp indicator and temperature warning indicator) on the projector indicate problems inside the projector.
- If a problem occurs, either the temperature warning indicator or the lamp indicator will illuminate red, and the projector will enter the standby mode. After the projector has entered the standby mode, follow the procedures given below.

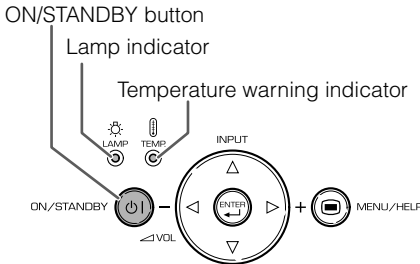

## About the temperature warning indicator



If the temperature inside the projector increases, due to blockage of the air vents, or the setting location, "TEMP." will illuminate in the lower left corner of the picture. If the temperature keeps on rising, the lamp will turn off and the temperature warning indicator will blink, the cooling fan will run, and then the projector will enter the standby mode. After "TEMP." appears, be sure to perform the measures described on page 54.

## About the lamp indicator





- When the remaining lamp life becomes 5% or less, (yellow) and "Change The Lamp" will be displayed on the screen. When the percentage becomes 0%, it will change to (red), the lamp will automatically turn off and then the projector will automatically enter the standby mode. At this time, the lamp indicator will illuminate in red.
- **If you try to turn on the projector a fourth time without replacing the lamp, the projector will not turn on.**

# Maintenance Indicators (Continued)

	Maintenance indicator		Problem	Cause	Possible Solution
	Normal	Abnormal			
Temperature warning indicator	Off	Red on (Standby)	The internal temperature is abnormally high.	<ul style="list-style-type: none"> <li>Blocked air intake</li> </ul>	<ul style="list-style-type: none"> <li>Relocate the projector to an area with proper ventilation. (see page 8)</li> </ul>
				<ul style="list-style-type: none"> <li>Cooling fan breakdown</li> <li>Internal circuit failure</li> <li>Clogged air intake</li> </ul>	<ul style="list-style-type: none"> <li>Take the projector to your nearest Sharp Authorized Projector Dealer or Service Center (see page 62) for repair.</li> </ul>
Lamp indicator	Green on (Green blinks when the lamp is warming up.)	Red on	The lamp does not illuminate.	<ul style="list-style-type: none"> <li>The lamp is shut down abnormally.</li> </ul>	<ul style="list-style-type: none"> <li>Disconnect the power cord from the AC outlet, and then connect it again.</li> </ul>
			Time to change the lamp.	<ul style="list-style-type: none"> <li>Remaining lamp life becomes 5% or less.</li> </ul>	<ul style="list-style-type: none"> <li>Carefully replace the lamp. (See page 56.)</li> <li>Take the projector to your nearest Sharp Authorized Projector Dealer or Service Center (see page 62) for repair.</li> <li>Please exercise care when replacing the lamp.</li> <li>Securely install the cover.</li> </ul>
		Red on (Standby)	The lamp does not illuminate.	<ul style="list-style-type: none"> <li>Burnt-out lamp</li> <li>Lamp circuit failure</li> </ul>	
Power button	Green on/ Red on	Red blinks	The power indicator blinks in red when the projector is on.	<ul style="list-style-type: none"> <li>The lamp unit cover is open.</li> </ul>	<ul style="list-style-type: none"> <li>If the power indicator blinks in red even when the lamp unit cover is secured installed, contact your nearest Sharp Authorized Projector Dealer or Service Center (see page 62) for advice.</li> </ul>

## Info

- If the temperature warning indicator illuminates, and the projector enters the standby mode, follow the possible solutions above and then wait until the projector has cooled down completely before plugging in the power cord and turning the power back on. (At least 10 minutes.)
- If the power is turned off for a brief moment due to power outage or some other cause while using the projector, and the power supply recovers immediately after that, the lamp indicator will illuminate in red and the lamp may not be lit. In this case, unplug the power cord from the AC outlet, replace the power cord in the AC outlet and then turn the power on again.
- If you want to clean the air vents during projector operation, be sure to press  ON/STANDBY on the projector or  ON/STANDBY on the remote control and put the projector into the standby mode. After the cooling fan has stopped, clean the vents.
- The cooling fan keeps the internal temperature of the projector constant and this function is controlled automatically. The sound of the cooling fan may change during operation because the fan speed may change and this is not a malfunction.
- Do not unplug the power cord after the projector has entered the standby mode and while the cooling fan is running. The cooling fan runs for about 90 seconds.

# Regarding the Lamp

## Lamp

- It is recommended that the lamp (sold separately) be replaced when the remaining lamp life becomes 5% or less, or when you notice a significant deterioration in the picture and color quality. The lamp life (percentage) can be checked with the on-screen display. (see page 50)
- Purchase a replacement lamp of type AN-XR1LP from your place of purchase, nearest Sharp Projector Dealer or Service Center.

### IMPORTANT NOTE TO U.S. CUSTOMERS:

The lamp included with this projector is backed by a 90-day parts and labor limited warranty. All service of this projector under warranty, including lamp replacement, must be obtained through a Sharp Authorized Projector Dealer or Service Center. For the name of the nearest Sharp Authorized Projector Dealer or Service Center, please call toll-free: 1-888-GO-SHARP (1-888-467-4277).

**Hg LAMP CONTAINS MERCURY** For State Lamp Disposal Information

[www.lamprecycle.org](http://www.lamprecycle.org) or 1-800-BE-SHARP

U.S.A. ONLY

## Caution Concerning the Lamp

- This projector utilizes a pressurized mercury lamp. A loud sound may indicate lamp failure. Lamp failure can be attributed to numerous sources such as: excessive shock, improper cooling, surface scratches or deterioration of the lamp due to a lapse of usage time.  
The period of time up to failure largely varies depending on the individual lamp and/or the condition and the frequency of use. It is important to note that failure can often result in the bulb cracking.
- When the lamp replacement indicator and on-screen display icon are illuminated, it is recommended that the lamp be replaced with a new one immediately, even if the lamp appears to be operating normally.
- Should the lamp break, there is also a possibility that glass particles may spread inside of the projector. In such a case, it is recommended you contact your nearest Sharp Authorized Projector Dealer or Service Center to assure safe operation.
- Should the lamp break, the glass particles may spread inside the lamp cage or gas contained in the lamp may be vented into the room from the exhaust vent. Because the gas in this lamp includes mercury, ventilate the room well if the lamp breaks and avoid all exposure to the released gas. In case of exposure to the gas, consult a doctor as soon as possible.

## Replacing the Lamp

- Do not remove the lamp unit from the projector right after use. The lamp will be very hot and may cause burn or injury.
- **Carefully change the lamp by following the instructions described in this section. \* If you wish, you may have the lamp replaced at your nearest Sharp Authorized Projector Dealer or Service Center.**

\* If the new lamp does not light after replacement, take your projector to the nearest Sharp Authorized Projector Dealer or Service Center for repair.

# Regarding the Lamp (Continued)

## Removing and Installing the Lamp Unit

### Info

- Be sure to remove the lamp unit using the handle. Be sure not to touch the glass surface of the lamp unit or the inside of the projector.
- To avoid injury to yourself and damage to the lamp, be sure to carefully follow the steps below.
- Do not loosen other screws except for the lamp unit cover and lamp unit.

Optional accessory

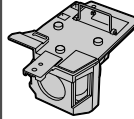

Lamp unit AN-XR1LP

- 1 Press  ON/STANDBY on the projector or  ON/STANDBY on the remote control to put the projector into the standby mode.**

- Wait until the cooling fan stops.

### Warning!

- Do not remove the lamp unit from the projector right after use. The lamp and parts around the lamp will be very hot and may cause burns or injury.

- 2 Disconnect the power cord.**
  - Unplug the power cord from the AC socket.
  - Leave the lamp until it has fully cooled down (about 1 hour).

- 3 Remove the lamp unit cover.**
  - Turn the projector over. Loosen the user service screw (1) that secures the lamp unit cover. Remove the lamp unit cover (2).

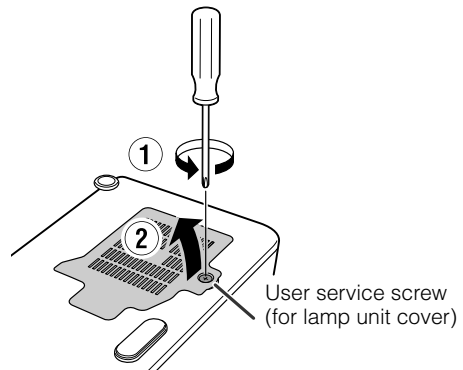
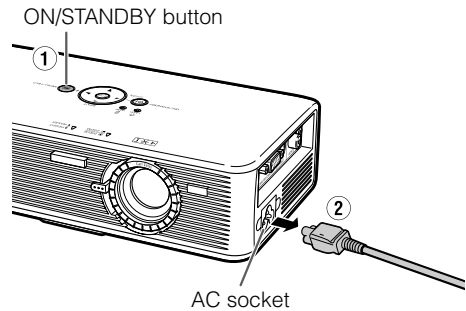

#### 4 Remove the lamp unit.

- Loosen the securing screws from the lamp unit. Hold the lamp unit by the handle and pull it in the direction of the arrow. At this time, keep the lamp unit horizontal and do not tilt it.

#### 5 Insert the new lamp unit.

- Press the lamp unit firmly into the lamp unit compartment. Fasten the securing screws.

#### 6 Replace the lamp unit cover.

- Align the tab on the lamp unit cover (①) and place it while pressing the tab (②) to close it. Then tighten the user service screw (③) to secure the lamp unit cover.

#### Info

- If the lamp unit and lamp unit cover are not correctly installed, the power will not turn on, even if the power cord is connected to the projector.

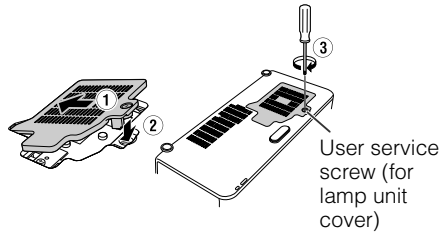
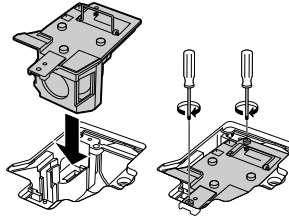
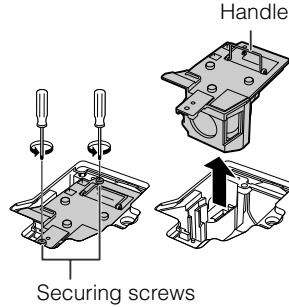

## Resetting the Lamp Timer

Reset the lamp timer after replacing the lamp.

#### Info

- Make sure to reset the lamp timer only when replacing the lamp. If you reset the lamp timer and continue to use the same lamp, this may cause the lamp to become damaged or explode.

#### 1 Connect the power cord.

- Plug the power cord into the AC socket of the projector.

#### 2 Reset the lamp timer.

- While simultaneously holding down  $\ominus$  MENU,  $\ominus$  ENTER and  $\nabla$  on the projector, press and  $\odot$  ON/STANDBY on the projector.
- "LAMP 0000H" is displayed, indicating that the lamp timer is reset.

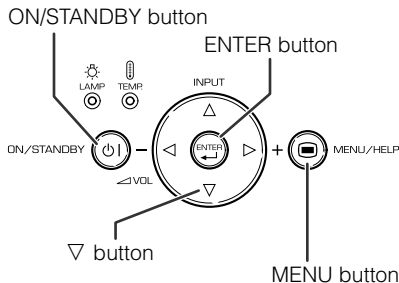
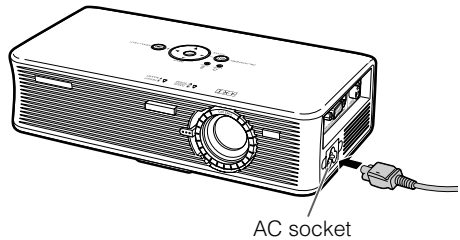

# Connecting Pin Assignments

INPUT 1 RGB Signal Terminal: 15-pin Mini D-sub female connector

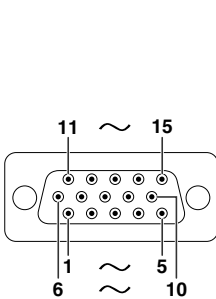

## RGB Input

1. Video input (red)
2. Video input (green/sync on green)
3. Video input (blue)
4. Not connected
5. Not connected
6. Earth (red)
7. Earth (green/sync on green)
8. Earth (green/sync on green)
9. Not connected
10. GND
11. Not connected
12. Bi-directional data
13. Horizontal sync signal: TTL level
14. Horizontal sync signal: TTL level
15. Data clock

## Component Input

1. PR (CR)
2. Y
3. PB (CB)
4. Not connected
5. Not connected
6. Earth (PR)
7. Earth (PR)
8. Earth (PB)
9. Not connected
10. Not connected
11. Not connected
12. Not connected
13. Not connected
14. Not connected
15. Not connected

USB Terminal: 4-pin B-type USB female connector

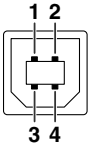

- | Signal  | Signal name |
|---------|-------------|
| 1. SG   | GND         |
| 2. USB+ | USB data+   |
| 3. VCC  | USB power   |
| 4. USB- | USB data-   |

# Computer Compatibility Chart

## Computer

- Multiple signal support  
Horizontal Frequency: 15-70 kHz,  
Vertical Frequency: 45-85 Hz,  
Pixel Clock: 12-108 MHz  
Sync signal: Compatible with TTL level
- Compatible with sync on green signal
- SXGA+, SXGA and XGA compatible in intelligent compression
- Intelligent Compression and Expansion System resizing technology

The following is a list of modes that conform to VESA. However, this projector supports other signals that are not VESA standards.

PC/MAC/WS	Resolution	Horizontal Frequency (kHz)	Vertical Frequency (Hz)	VESA Standard	Display		
PC	VGA	640 × 350	27.0	60		Upscale	
			31.5	70			
			37.5	85	✓		
		640 × 400	27.0	60			
			31.5	70			
			37.9	85	✓		
		720 × 350	27.0	60			
			31.5	70			
			37.9	85	✓		
		720 × 400	27.0	60			
				31.5	70		
				37.9	85		✓
	640 × 480		26.2	50			
			31.5	60	✓		
			34.7	70			
	SVGA	800 × 600	37.9	72	✓	True	
			37.5	75	✓		
			43.3	85	✓		
			31.4	50			
			35.1	56	✓		
			37.9	60	✓		
		XGA	1,024 × 768	46.6	70		
				48.1	72	✓	
				46.9	75	✓	
				53.7	85	✓	
				40.3	50		
				48.4	60	✓	
	SXGA	1,152 × 864	56.5	70	✓	Intelligent Compression	
			60.0	75	✓		
			68.7	85	✓		
			55.0	60			
			66.2	70			
			67.5	75			
SXGA+	1,280 × 1,024	64.0	60	✓			
		64.0	60	✓			
MAC 13"	VGA	640 × 480	34.9	67	Upscale		
MAC 16"	SVGA	832 × 624	49.7	75	Intelligent Compression		
MAC 19"	XGA	1,024 × 768	60.2	75			
MAC 21"	SXGA	1,152 × 870	68.7	75			







### Note

- This projector may not be able to display images from notebook computers in simultaneous (CRT/LCD) mode. Should this occur, turn off the LCD display on the notebook computer and output the display data in "CRT only" mode. Details on how to change display modes can be found in your notebook computer's operation manual.
- When this projector receives 640 × 350 VESA format VGA signals, "640 × 400" appears on the screen.

## DTV

Signal	Horizontal Frequency (kHz)	Vertical Frequency (Hz)
480I	15.7	60
480P	31.5	60
540P	33.8	60
576I	15.6	50
576P	31.3	50
720P	45.0	60
1035I	28.1	50
1035I	33.8	60
1080I	28.1	50
1080I	33.8	60

# Troubleshooting

Problem	Check	Page
 No picture and no sound or projector does not start.	<ul style="list-style-type: none"> <li>• Projector power cord is not plugged into the wall outlet.</li> </ul>	25
	<ul style="list-style-type: none"> <li>• Power to the external connected devices is off.</li> </ul>	–
	<ul style="list-style-type: none"> <li>• The selected input mode is wrong.</li> </ul>	29
	<ul style="list-style-type: none"> <li>• Cables incorrectly connected to the projector.</li> </ul>	23, 24, 25
	<ul style="list-style-type: none"> <li>• Remote control battery has run out.</li> </ul>	14, 15
	<ul style="list-style-type: none"> <li>• External output has not been set when connecting notebook computer.</li> </ul>	23
 Sound is heard but no picture appears (or picture is dark).	<ul style="list-style-type: none"> <li>• The lamp unit cover is not installed correctly.</li> </ul>	56, 57
	<ul style="list-style-type: none"> <li>• Cables incorrectly connected to the projector.</li> <li>• “Bright” is set to minimum position.</li> </ul>	23, 24, 25 40
 Color is faded or poor.	<ul style="list-style-type: none"> <li>• Image adjustments are incorrectly set.</li> </ul> (Video Input only)	40
	<ul style="list-style-type: none"> <li>• Video input system is incorrectly set.</li> </ul>	51
 Picture is blurred; noise appears.	<ul style="list-style-type: none"> <li>• Adjust the focus.</li> </ul>	27
	<ul style="list-style-type: none"> <li>• The projection distance exceeds the focus range.</li> </ul>	20
	(Computer Input only) <ul style="list-style-type: none"> <li>• Perform “Fine Sync” Adjustments (“Clock” Adjustment)</li> <li>• Perform “Fine Sync” Adjustments (“Phase” Adjustment)</li> <li>• Noise may appear depending on the computer.</li> </ul>	51 51 –
 Picture appears but no sound is heard.	<ul style="list-style-type: none"> <li>• Cables incorrectly connected to the projector.</li> </ul>	23, 24, 25
	<ul style="list-style-type: none"> <li>• Volume is set to minimum.</li> </ul>	29
An unusual sound is occasionally heard from the cabinet.	<ul style="list-style-type: none"> <li>• If the picture is normal, the sound is due to cabinet shrinkage caused by room temperature changes. This will not affect operation or performance.</li> </ul>	–
Maintenance indicator on the projector illuminates or blinks in red.	<ul style="list-style-type: none"> <li>• See “Maintenance Indicators”.</li> </ul>	54



Problem	Check	Page
Picture is green on INPUT 1 COMPONENT.	<ul style="list-style-type: none"> <li>Change the input signal type setting.</li> </ul>	51
Picture is pink (no green) on INPUT 1 RGB.		
Picture is too bright and whitish.	<ul style="list-style-type: none"> <li>Image adjustments are incorrectly set.</li> </ul>	40
The cooling fan becomes noisy.	<ul style="list-style-type: none"> <li>When temperature inside the projector increases, the cooling fan runs faster.</li> </ul>	–
The lamp does not light up even after the projector turns on.	<ul style="list-style-type: none"> <li>The lamp indicator is illuminating in red. Replace the lamp.</li> </ul>	53
The lamp suddenly turns off during projection		
The image sometimes flickers.	<ul style="list-style-type: none"> <li>Cables incorrectly connected to the projector or the connected equipment works improperly.</li> <li>If this happens frequently, replace the lamp.</li> </ul>	23, 24, 25, 51, 56
The lamp needs much time to turn on.	<ul style="list-style-type: none"> <li>The lamp will eventually need to be changed. While the remaining lamp life draws to a close, replace the lamp.</li> </ul>	56
Picture is dark.		

# For SHARP Assistance

If you encounter any problems during setup or operation of this projector, first refer to the “Troubleshooting” section on pages 60 and 61. If this operation manual does not answer your question, please contact the SHARP Service departments listed below.

<b>U.S.A.</b>	<b>Sharp Electronics Corporation</b> 1-888-GO-SHARP (1-888-467-4277)  lcdsupport@sharpsec.com <a href="http://www.sharplcd.com">http://www.sharplcd.com</a>	<b>Benelux</b>	<b>SHARP Electronics Benelux BV</b> 0900-SHARPCE (0900-7427723) Nederland 9900-0159 Belgium <a href="http://www.sharp.nl">http://www.sharp.nl</a> <a href="http://www.sharp.be">http://www.sharp.be</a> <a href="http://www.sharp.lu">http://www.sharp.lu</a>
<b>Canada</b>	<b>Sharp Electronics of Canada Ltd.</b>  (905) 568-7140 <a href="http://www.sharp.ca">http://www.sharp.ca</a>	<b>Australia</b>	<b>Sharp Corporation of Australia Pty. Ltd.</b> 1300-135-022 <a href="http://www.sharp.net.au">http://www.sharp.net.au</a>
<b>Mexico</b>	<b>Sharp Electronics Corporation Mexico Branch</b> (525) 716-9000 <a href="http://www.sharp.com.mx">http://www.sharp.com.mx</a>	<b>New Zealand</b>	<b>Sharp Corporation of New Zealand</b> (09) 634-2059, (09) 636-6972 <a href="http://www.sharpnz.co.nz">http://www.sharpnz.co.nz</a>
<b>Latin America</b>	<b>Sharp Electronics Corp. Latin American Group</b> (305) 264-2277 <a href="http://www.servicio@sharpsec.com">www.servicio@sharpsec.com</a> <a href="http://www.siempresharp.com">http://www.siempresharp.com</a>	<b>Singapore</b>	<b>Sharp-Roxy Sales (S) Pte. Ltd.</b> 65-226-6556 <a href="mailto:ckng@srs.global.sharp.co.jp">ckng@srs.global.sharp.co.jp</a> <a href="http://www.sharp.com.sg">http://www.sharp.com.sg</a>
<b>Germany</b>	<b>Sharp Electronics (Europe) GMBH</b> 01805-234675 <a href="http://www.sharp.de">http://www.sharp.de</a>	<b>Hong Kong</b>	<b>Sharp-Roxy (HK) Ltd.</b> (852) 2410-2623 <a href="mailto:dcmktg@srh.global.sharp.co.jp">dcmktg@srh.global.sharp.co.jp</a> <a href="http://www.sharp.com.hk">http://www.sharp.com.hk</a>
<b>U.K.</b>	<b>Sharp Electronics (U.K.) Ltd.</b> 0161-205-2333 <a href="mailto:cic@sharp-uk.co.uk">cic@sharp-uk.co.uk</a> <a href="http://www.sharp.co.uk">http://www.sharp.co.uk</a>	<b>Taiwan</b>	<b>Sharp Corporation (Taiwan)</b> 0800-025111 <a href="http://www.sharp-scot.com.tw">http://www.sharp-scot.com.tw</a>
<b>Italy</b>	<b>Sharp Electronics (Italy) S.P.A.</b> (39) 02-89595-1 <a href="http://www.sharp.it">http://www.sharp.it</a>	<b>Malaysia</b>	<b>Sharp-Roxy Sales &amp; Service Co.</b> (60) 3-5125678
<b>France</b>	<b>Sharp Electronics France</b> 01 49 90 35 40 <a href="mailto:hotlineced@sef.sharp-eu.com">hotlineced@sef.sharp-eu.com</a> <a href="http://www.sharp.fr">http://www.sharp.fr</a>	<b>U.A.E.</b>	<b>Sharp Middle East Fze</b> 971-4-81-5311 <a href="mailto:helpdesk@smef.global.sharp.co.jp">helpdesk@smef.global.sharp.co.jp</a>
<b>Spain</b>	<b>Sharp Electronica Espana, S.A.</b> 93 5819700 <a href="mailto:sharplcd@sees.sharp-eu.com">sharplcd@sees.sharp-eu.com</a> <a href="http://www.sharp.es">http://www.sharp.es</a>	<b>Thailand</b>	<b>Sharp Thebnakorn Co. Ltd.</b> 02-236-0170 <a href="mailto:svc@stcl.global.sharp.co.jp">svc@stcl.global.sharp.co.jp</a> <a href="http://www.sharp-th.com">http://www.sharp-th.com</a>
<b>Switzerland</b>	<b>Sharp Electronics (Schweiz) AG</b> 0041 1 846 63 11 <a href="mailto:cattaneo@sez.sharp-eu.com">cattaneo@sez.sharp-eu.com</a> <a href="http://www.sharp.ch">http://www.sharp.ch</a>	<b>Korea</b>	<b>Sharp Electronics Incorporated of Korea</b> (82) 2-3660-2002 <a href="mailto:lcd@sharp-korea.co.kr">lcd@sharp-korea.co.kr</a> <a href="http://www.sharpkorea.co.kr">http://www.sharpkorea.co.kr</a>
<b>Sweden</b>	<b>Sharp Electronics (Nordic) AB</b> (46) 8 6343600 <a href="mailto:vision.support@sen.sharp-eu.com">vision.support@sen.sharp-eu.com</a> <a href="http://www.sharp.se">http://www.sharp.se</a>	<b>India</b>	<b>Sharp Business Systems (India) Limited</b> (91) 11- 6431313 <a href="mailto:service@sharp-oa.se">service@sharp-oa.se</a>
<b>Austria</b>	<b>Sharp Electronics Austria (Ges.m.b.H.)</b> 0043 1 727 19 123 <a href="mailto:pogats@sea.sharp-eu.com">pogats@sea.sharp-eu.com</a> <a href="http://www.sharp.at">http://www.sharp.at</a>		

# Specifications

Product type	Projector
Model	XR-1S
Video system	NTSC3.58/NTSC4.43/PAL/PAL-M/PAL-N/PAL-60/SECAM/DTV480I/DTV480P/DTV540P/DTV576I/DTV576P/DTV720P/DTV1035I/DTV1080I/DTV1080I-50
Display method	Single Chip Digital Micromirror Device™ (DMD™) by Texas Instruments
DMD panel	Panel size: 0.55" (13.7 mm) (8.2 [H] × 10.9 [W] mm), 1 chip SVGA DMD
Lens	No. of dots: 480,000 dots (800 [H] × 600 [V]) 1–1.16 × zoom lens, F2.60–2.84, f = 19.3–22.6 mm
Projection lamp	150 W DC lamp
Component input signal (INPUT1)	15-pin mini D-sub connector Y: 1.0 Vp-p, sync negative, 75 Ω terminated P <sub>B</sub> : 0.7 Vp-p, 75 Ω terminated P <sub>R</sub> : 0.7 Vp-p, 75 Ω terminated
Horizontal resolution	520 TV lines (DTV720P)
Computer RGB input signal (INPUT 1)	15-pin mini D-sub connector RGB separate/sync on green type analog input: 0–0.7 Vp-p, positive, 75 Ω terminated HORIZONTAL SYNC. SIGNAL: TTL level (positive/negative) VERTICAL SYNC. SIGNAL: Same as above
S-video input signal (INPUT 2)	4-pin mini DIN connector Y (luminance signal): 1.0 Vp-p, sync negative, 75 Ω terminated C (chrominance signal): Burst 0.286 Vp-p, 75 Ω terminated
Video input signal (INPUT 3)	RCA connector: VIDEO, composite video, 1.0 Vp-p, sync negative, 75 Ω terminated
Pixel clock	12–108 MHz
Vertical frequency	45–85 Hz
Horizontal frequency	15–70 kHz
Audio input signal	ø3.5 mm minijack: AUDIO, 0.5 Vrms, more than 22 kΩ (stereo)
Speaker system	2.8 cm round × 1
Rated voltage	AC 100–240 V
Input current	2.0 A
Rated frequency	50/60 Hz
Power consumption	195 W (Standard mode)/177 W (Eco/Quiet mode "On") with AC 100 V 190 W (Standard mode)/167 W (Eco/Quiet mode "On") with AC 240 V
Power consumption (standby)	4 W (AC 100 V) – 5 W (AC 240 V)
Heat dissipation	730 BTU/hour (Standard mode)/660 BTU/hour (Eco/Quiet mode "On") with AC 100 V 710 BTU/hour (Standard mode)/630 BTU/hour (Eco/Quiet mode "On") with AC 240 V
Operating temperature	41°F to 95°F (+5°C to +35°C)
Storage temperature	–4°F to 140°F (–20°C to +60°C)
Cabinet	Plastic
I/R carrier frequency	38 kHz
Dimensions (approx.)	9 <sup>47</sup> / <sub>64</sub> " × 2 <sup>17</sup> / <sub>32</sub> " × 4 <sup>13</sup> / <sub>16</sub> " (247 (W) × 64 (H) × 122 (D) mm) (main body only) 9 <sup>47</sup> / <sub>64</sub> " × 2 <sup>23</sup> / <sub>32</sub> " × 4 <sup>13</sup> / <sub>16</sub> " (247 (W) × 69 (H) × 122 (D) mm) (including adjustment foot and projecting parts)
Weight (approx.)	3.20 lbs. (1.45 kg)
Supplied accessories	Remote control, Lithium battery, Power cord for U.S., Canada etc. (6', 1.8 m), Power cord for Europe, except U.K. (6', 1.8 m), Power cord for U.K., Hong Kong and Singapore (6', 1.8 m), Power cord for Australia, New Zealand and Oceania (6', 1.8 m), RGB/USB cable (6', 1.8 m), Cable tie × 2, Soft case, Projector manual CD-ROM, Operation manual
Replacement parts	Lamp unit (Lamp/cage module) (AN-XR1LP), Remote control (RRMCGA256WJSA), Lithium battery, Power cord for U.S., Canada etc. (QACCCA029WJPZ), Power cord for Europe, except U.K. (QACCVA006WJPZ), Power cord for U.K., Hong Kong and Singapore (QACBA015WJPZ), Power cord for Australia, New Zealand and Oceania (QACCLA024WJPZ), RGB/USB cable (QCNWGA047WJPZ), Cable tie (UBNDTA015WJZZ), Soft case (GCASNA011WJZZ), Projector manual CD-ROM (UDSKAA045WJZZ), Operation manual (TINS-B148WJZZ)

*As a part of policy of continuous improvement, SHARP reserves the right to make design and specification changes for product improvement without prior notice. The performance specification figures indicated are nominal values of production units. There may be some deviations from these values in individual units.*

# Dimensions

Units: inches (mm)

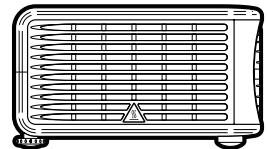
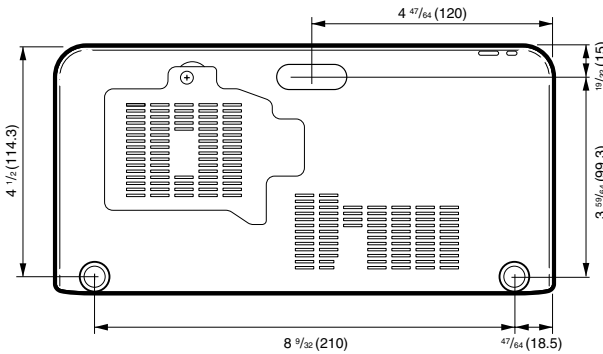
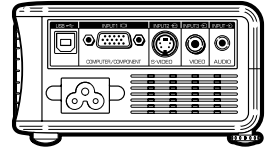
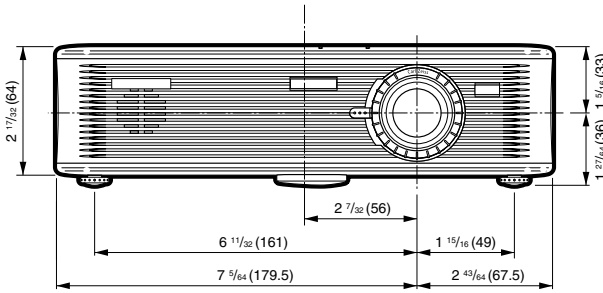
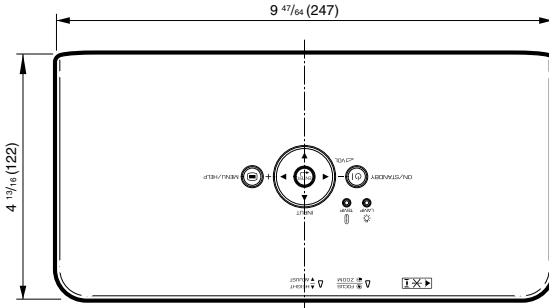

# Index

AC socket .....	25	Lamp Timer (Life) .....	50
Accessories .....	11	Lamp unit .....	56
Adjustment buttons .....	36	Language (on-screen display language) .....	46
Adjust vertical noise .....	35, 51	Lithium Battery .....	14, 15
Aspect ratio .....	30	MENU/HELP button .....	36, 51
AUDIO INPUT terminal .....	23, 24, 25	MOUSE/Adjustment buttons .....	33
Auto Keystone Correction .....	44	Mouse function .....	33
Auto Power Off .....	48	NORMAL .....	30, 31
Auto Search .....	47	ON/STANDBY button .....	26
Auto Sync (Auto Sync adjustment) .....	32, 35, 51	Optional accessories .....	11
AUTO SYNC button .....	32	OSD Display .....	44
AV MUTE button .....	29	PDF .....	10
Background .....	45	Phase .....	51
Blue .....	40	Picture Adjustment .....	40
BORDER .....	30, 31	Picture Mode .....	40
Bright .....	40	Power cord .....	25
Bright Boost .....	41	PRJ - ADJ .....	47
Clock .....	51	PRJ Mode .....	46
CLR Temp (Color Temperature) .....	41	Progressive .....	42
Color .....	40	R CLICK/RETURN button .....	33
Contrast .....	40	Rear adjustment foot .....	28
Eco/Quiet Mode .....	47	Red .....	40
ENTER button .....	36	Remote control .....	14
Exhaust vent .....	13	Remote control sensor .....	15
Fine Sync .....	51	Replacing the lamp .....	55
Focus ring .....	27	Resize .....	43
FREEZE button .....	32	RESIZE button .....	30
Front adjustment foot .....	28	RETURN button .....	37
Guide LEDs .....	48	RGB/USB cable .....	23
H-Pos .....	35, 51	SCR - ADJ .....	43
HEIGHT ADJUST button .....	28	Setup Guide .....	27
Help .....	51	Sharp .....	40
Image shift .....	43	Soft case .....	11
INPUT 1 terminal .....	23, 24	sRGB .....	42
INPUT 1 – 3 modes .....	29	STRETCH .....	30, 31
INPUT 2 terminal .....	24	Supplied accessories .....	11
INPUT 3 terminal .....	25	System Lock .....	49
INPUT button .....	29	Temperature warning indicator .....	53
Intake vent .....	13, 52	Tint .....	40
Kensington Security Standard connector .....	13	USB terminal .....	23
Keycode .....	49	Video System .....	35
Keystone Correction .....	44	Volume buttons .....	29
L CLICK/ENTER button .....	33	V-Pos .....	35, 51
Lamp .....	55	Zoom knob .....	28
Lamp indicator .....	53		

**SHARP®**

**SHARP CORPORATION**