

SHARP®

OPERATION MANUAL



MODEL **XG-NV6XA**

中国规格

LCD PROJECTOR

Notevision
SLIM & COMPACT LCD PROJECTOR



Important Information



Setup & Connections



Operation



Useful Features



Maintenance & Troubleshooting



Appendix



Before using the LCD projector, please read this operation manual carefully.

OPERATION MANUAL

ENGLISH

IMPORTANT

For your assistance in reporting the loss or theft of your Colour LCD Projector, please record the Serial Number located on the bottom of the projector and retain this information. Before recycling the packaging, please be sure that you have checked the contents of the carton thoroughly against the list of "Supplied Accessories" on page 10.

Model No.: XG-NV6XA

Serial No.:

WARNING:

Intense light source. Do not look into the beam or view it directly. Be especially careful that children do not look directly into the beam.

WARNING:

To reduce the risk of fire or electric shock, do not expose this appliance to liquids.

CAUTION:

To reduce the risk of electric shock, do not remove cabinet. No user-serviceable parts are inside. Refer servicing to qualified service personnel.



Important Safeguards

ATTENTION: Please read all of these instructions before you operate your LCD Projector for the first time. Save these instructions for future reference.

For your own protection and prolonged operation of your LCD Projector, be sure to read the following “Important Safeguards” carefully, before use.

This projector has been engineered and manufactured to ensure your personal safety. But IMPROPER USE CAN RESULT IN POTENTIAL ELECTRICAL SHOCK OR FIRE HAZARDS. In order not to defeat the safeguards incorporated into this LCD Projector, observe the following basic rules for its installation, use and servicing.

1. Unplug the LCD Projector from the wall outlet before cleaning.
2. Do not use liquid cleaners or aerosol cleaners. Use a damp cloth for cleaning.
3. Do not use attachments not recommended by the LCD Projector manufacturer, as they may cause hazards.
4. Do not use the LCD Projector near water; for example, near a bathtub, washbowl, kitchen sink, laundry tub, in a wet basement, near a swimming pool, etc. Never spill liquid into the projector.
5. Do not place the LCD Projector on an unstable cart, stand, or table. The LCD Projector may fall, which may cause serious injury to a child or an adult, and/or serious damage to the unit.
6. Wall or Ceiling Mounting—The product should be mounted to a wall or ceiling only as recommended by the manufacturer.
7. LCD Projector equipment and cart combinations should be moved with care. Quick stops, excessive force, and uneven surfaces may cause the equipment and cart combination to overturn. 
8. Slots and openings in the cabinet back and bottom are provided for ventilation. To ensure reliable operation of the LCD Projector and to protect it from overheating, these openings must not be blocked or covered. The openings should never be covered with cloth or other material.
9. This LCD Projector should never be placed near or over a radiator or heating vent. The LCD Projector should not be placed in a built-in installation such as a bookcase unless proper ventilation is provided.
10. The LCD Projector should be operated only from the type of power source indicated on the back of the projector or in the specifications. If you are not sure of the type of power supplied to your home, consult your LCD Projector dealer or local power company.
11. Do not place the LCD Projector where the cord will be abused by persons walking on it.
12. Follow all warnings and instructions marked on the LCD Projector.
13. To prevent damage to the projector due to lightning and power-line surges, unplug the projector from the power outlet, when not in use.
14. Do not overload wall outlets and extension cords with too many products, because this can result in fire or electric shock.
15. Never push objects of any kind into the LCD Projector through the cabinet slots as they may touch high-voltage points or cause a short circuit. This could result in a fire or electric shock.
16. Do not attempt to service the LCD Projector yourself. Opening or removing covers may expose you to dangerous voltage or other hazards. Refer all servicing to qualified service personnel.
17. Unplug the LCD Projector equipment from the wall outlet and refer servicing to qualified service personnel under the following conditions:
 - a. When the power cord or plug is damaged or frayed.
 - b. If liquid has been spilled into the LCD Projector.
 - c. If the LCD Projector has been exposed to rain or water.
 - d. If the LCD Projector does not operate normally when you follow the operating instructions. Adjust only those controls that are covered by the operating instructions, as improper adjustment of other controls may cause damage and will often require extensive work by a qualified technician to restore the LCD Projector to normal operation.
 - e. If the LCD Projector has been dropped or the cabinet has been damaged.
 - f. When the LCD Projector exhibits a distinct change in performance—this indicates a need for service.
18. When replacement parts are required, be sure the service technician has used replacement parts specified by the manufacturer that have the same characteristics as the original parts. Unauthorised substitutions may result in fire, electric shock, or other hazards.
19. This LCD Projector is provided with one of the following types of plugs. If the plug should fail to fit into the power outlet, please contact your electrician. Do not defeat the safety purpose of the plug.
 - a. Two-wire type mains plug.
 - b. Three-wire grounding type mains plug with a grounding terminal.
This plug will only fit into a grounding type power outlet.



Outstanding Features

1. **ADVANCED COMPATIBILITY WITH HIGH-END WORKSTATIONS AND PCS**

Compatible with up to 200 Hz vertical refresh rate, Sync on Green and **Composite Sync** signals for use with a wide variety of high-end PCs and Workstations. (Page 11)

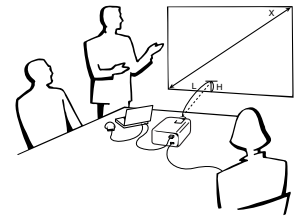

2. **FOR USE WITH DTV***

Allows projection of DTV images and 16:9 wide-screen images when connected to a DTV decoder or similar video systems. (Page 13)

3. **BNC TERMINALS FOR COMPONENT AND RGB INPUT**

Equipped with BNC terminals for connection to a DTV decoder, DVD player and similar video systems for higher quality images. An RCA adaptor can also be used with the BNC terminals. (Page 13)

4. **3-D Y/C DIGITAL COMB FILTER**

Provides high quality images with minimal dot crawl and cross colour noise.

5. **POWER ZOOM AND FOCUS FUNCTION**

Features a 130% power zoom function that allows you to easily adjust the screen size with the remote control. Use these functions when adjusting the projection distance to achieve a 102- to 762-cm (40- to 300-inch) screen size. (Page 19)

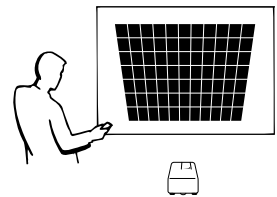

6. **DIGITAL KEYSTONE CORRECTION**

Digitally adjusts an image that is projected at an angle while maintaining image quality and brightness. (Page 19)

7. **EASY-TO-USE GRAPHICAL USER INTERFACE (GUI)**

A multi-colour, icon based menu system allows for simple image adjustments. (Page 23)

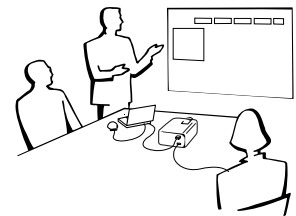

8. **USER-FRIENDLY DESIGN**

The two-colour design along with an intuitive Graphical User Interface (GUI) makes this projector very easy to set up and adjust.

9. **WIRELESS PRESENTATIONS WITH IrCOM**

The IrCOM function allows for wireless transmission of digital images via infrared communication from a PC or digital camera. (Page 25)

10. **AUTO SYNC TECHNOLOGY FOR AUTOMATIC IMAGE PERFECTION**

Automatically makes any necessary adjustments for perfectly synced computer images. (Page 29)

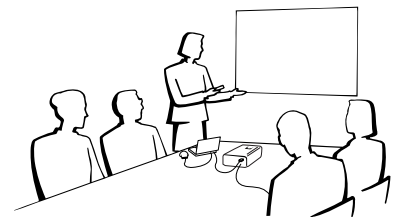

11. **INTELLIGENT COMPRESSION AND EXPANSION**

By using intelligent resizing technology, this projector can display higher and lower resolution images in detail without compromising quality. (Page 36)

12. **XGA RESOLUTION FOR HIGH RESOLUTION PRESENTATIONS**

With XGA (1,024 × 768) resolution, this projector can display very detailed presentation information.

13. **UXGA COMPATIBLE**

UXGA (1,600 × 1,200) resolution images are intelligently resized to 1,024 × 768 for full-screen or default presentations.

14. **CUSTOMISABLE STARTUP SCREEN**

Allows you to load a custom startup image (i.e. your company logo) to be displayed while the projector is warming up. (Page 41)

15. **BUILT-IN PRESENTATION TOOLS**

A variety of helpful presentation utilities are incorporated to enhance presentations. These include "Stamp" functions, "Break Timer", and "Digital Enlarge". (Page 43)

*DTV is the umbrella term used to describe the new digital television system in the united states.

Contents

Important Information

| | |
|--|---|
| Important Safeguards | 2 |
| Outstanding Features | 3 |
| Contents | 4 |
| Usage Guidelines | 5 |
| How to Access the PDF Operation Manuals (for Windows and Macintosh) | 6 |
| Part Names | 7 |

Setup & Connections

| | |
|-----------------------------------|----|
| Setting up the Projector | 10 |
| 1. Supplied Accessories | 10 |
| 2. Connecting the Projector | 11 |

Operation

| | |
|--|----|
| Basic Operations | 16 |
| 1. Turning on/off the Power | 16 |
| 2. Setting up the Screen | 18 |
| 3. Operating the Wireless Mouse from the Remote Control | 21 |
| Using the GUI (Graphical User Interface) Menu Screens | 23 |
| Using IrCOM for Wireless Presentations | 25 |
| Selecting the On-screen Display Language ... | 26 |
| Selecting the Video Input System Mode (VIDEO mode only) | 26 |
| Picture Adjustments | 27 |
| Audio Adjustments | 28 |
| Computer Image Adjustments | 29 |
| Auto Sync Adjustment | 30 |
| Auto Sync Display Function | 30 |
| Saving and Selecting Adjustment Settings ... | 31 |
| Special Mode Adjustment | 32 |

Useful Features

| | |
|---|----|
| Freeze Function | 33 |
| Digital Image Magnification | 34 |
| Gamma Correction | 35 |
| Selecting the Picture Display Mode | 36 |
| Black Screen Function | 37 |
| On-screen Display Override Function | 37 |
| Selecting the Economy Mode | 38 |
| I/P Conversion | 39 |
| Checking the Lamp Usage Time | 39 |
| Selecting the Signal Type | 40 |
| Checking the Input Signal | 40 |
| Setting a Background Image | 41 |
| Selecting a Startup Image | 41 |
| Reverse/Invert Image Function | 42 |
| Using the Presentation Tools | 43 |
| Status Function | 44 |

Maintenance & Troubleshooting

| | |
|-----------------------------------|----|
| Air Filter Maintenance | 46 |
| Lamp/Maintenance Indicators | 47 |
| Using the Kensington Lock | 48 |
| Troubleshooting | 48 |

Appendix

| | |
|---|----|
| Optional Lenses | 49 |
| Transporting the Projector | 49 |
| Connection Pin Assignments | 50 |
| RS-232C Port Specifications | 51 |
| Wired Remote Control Terminal Specifications | 53 |
| Input Signals (Recommended Timing) | 54 |
| Specifications | 56 |
| Dimensions | 57 |
| Guide to Effective Presentations | 58 |
| Glossary | 62 |
| Index | 63 |



Usage Guidelines

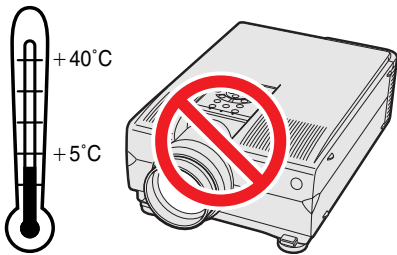
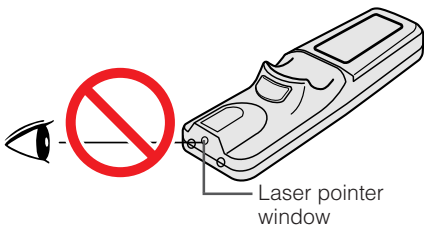
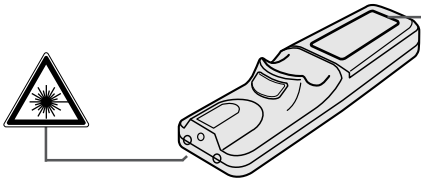

Cautions Concerning the Laser Pointer

The laser pointer on the remote control emits a laser beam from the laser pointer window. This is a Class II laser which may impair your sight if directed into the eyes. The two marks shown on the left are caution labels for the laser beam.

- Do not look into the laser pointer window or shine the laser beam on yourself or others. (The laser beam used in this product is harmless when directed onto the skin. However, be careful not to project the beam directly into the eyes.)
- Always use the laser pointer at temperatures between +5°C and +40°C.
- Use of controls or adjustments, or performance of procedures other than those specified herein may result in hazardous radiation exposure.

Cautions Concerning the Setup of the Projector

For minimal servicing and to maintain high image quality, SHARP recommends that this projector be installed in an area free from humidity, dust and cigarette smoke. If the projector is used in these environments, the lens and filter will need to be cleaned (or the filter replaced) more often, and internal cleaning may become necessary. As long as the projector is regularly cleaned, use in these environments will not reduce the overall operation life of the unit. Internal cleaning should only be performed by an Authorised Sharp Industrial LCD Products Dealer or Service Centre.

Notes on Operation

- The exhaust vent, the lamp cage cover and adjacent areas may be extremely hot during projector operation. To prevent injury, do not touch these areas until they have sufficiently cooled.
- Allow at least 10 cm of space between the cooling fan (exhaust vent) and the nearest wall or obstruction.
- If the cooling fan becomes obstructed, a protection device will automatically turn off the projector lamp. This does not indicate a malfunction. Remove the projector power cord from the wall outlet and wait at least 10 minutes. Then turn on the power by plugging the power cord back in. This will return the projector to the normal operating condition.

Temperature Monitor Function

If the projector starts to overheat due to setup problems or a dirty air filter, "TEMP." and "TEMP." will flash in the lower-left corner of the picture. If the temperature continues to rise, the lamp will turn off, the TEMPERATURE WARNING indicator on the projector will flash, and after a 90-second cooling-off period the power will shut off. Refer to "Lamp/Maintenance Indicators" on page 47, for details.

NOTE

- The cooling fan regulates the internal temperature, and its performance is automatically controlled. The sound of the fan may change during projector operation due to changes in the fan speed.



How to Access the PDF Operation Manuals (for Windows and Macintosh)



PDF operation manuals in all languages are included in the CD-ROM. To utilise these manuals, you need to install Adobe Acrobat Reader on your PC (Windows or Macintosh). If you have not installed Acrobat Reader yet, you can download it from the Internet (<http://www.adobe.com>) or install it from the CD-ROM.

To Install Acrobat Reader from the CD-ROM

For Windows:

- ① Insert the CD-ROM in the CD-ROM drive.
- ② Double click on the "My Computer" icon.
- ③ Double click on the "CD-ROM" drive.
- ④ Double click on the "manuals" folder.
- ⑤ Double click on the "acrobat" folder.
- ⑥ Double click on the "windows" folder.
- ⑦ Double click on the desired installation programme and follow the instructions on the screen.

For Macintosh:

- ① Insert the CD-ROM in the CD-ROM drive.
- ② Double click on the "CD-ROM" icon.
- ③ Double click on the "manuals" folder.
- ④ Double click on the "acrobat" folder.
- ⑤ Double click on the "mac" folder.
- ⑥ Double click on the desired installation programme and follow the instructions on the screen.

For other operating systems:

Please download Acrobat Reader from the Internet (<http://www.adobe.com>).

For other languages:

If you prefer using Acrobat Reader for languages other than those included in the CD-ROM, please download the appropriate version from the Internet.

Accessing the PDF Manuals

For Windows:

- ① Insert the CD-ROM in the CD-ROM drive.
- ② Double click on the "My Computer" icon.
- ③ Double click on the "CD-ROM" drive.
- ④ Double click on the "manuals" folder.
- ⑤ Double click on the "xg-nv6xa" folder.
- ⑥ Double click on the language (name of the folder) that you want to view.
- ⑦ Double click on the "nv6" pdf file to access the projector manuals.
Double click on the "saps" pdf file to access the Sharp Advanced Presentation Software manual.
- ⑧ Double click on the pdf file.

For Macintosh:

- ① Insert the CD-ROM in the CD-ROM drive.
- ② Double click on the "CD-ROM" icon.
- ③ Double click on the "manuals" folder.
- ④ Double click on the "xg-nv6xa" folder.
- ⑤ Double click on the language (name of the folder) that you want to view.
- ⑥ Double click on the "nv6" pdf file to access the projector manuals.
Double click on the "saps" pdf file to access the Sharp Advanced Presentation Software manual.
- ⑦ Double click on the pdf file.

NOTE

- If the desired pdf file cannot be opened by double clicking the mouse, please start Acrobat Reader first, then specify the desired file using the "File", "Open" menu.
- See the "readme.txt" file on the CD-ROM for important information on the CD-ROM not included in this operation manual.



Part Names

Numbers next to the part names refer to the main pages in this manual where the topic is explained.

Projector

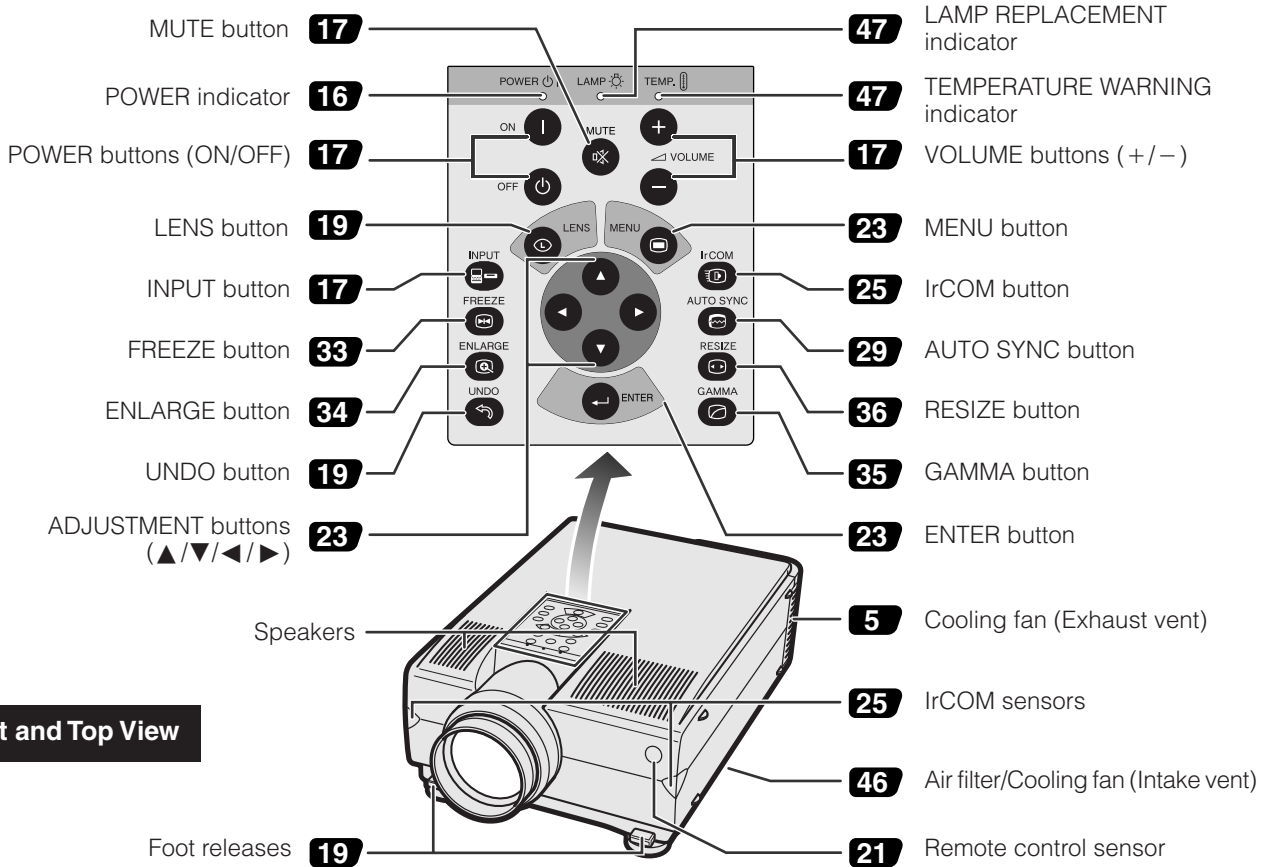

Front and Top View

Side and Rear View

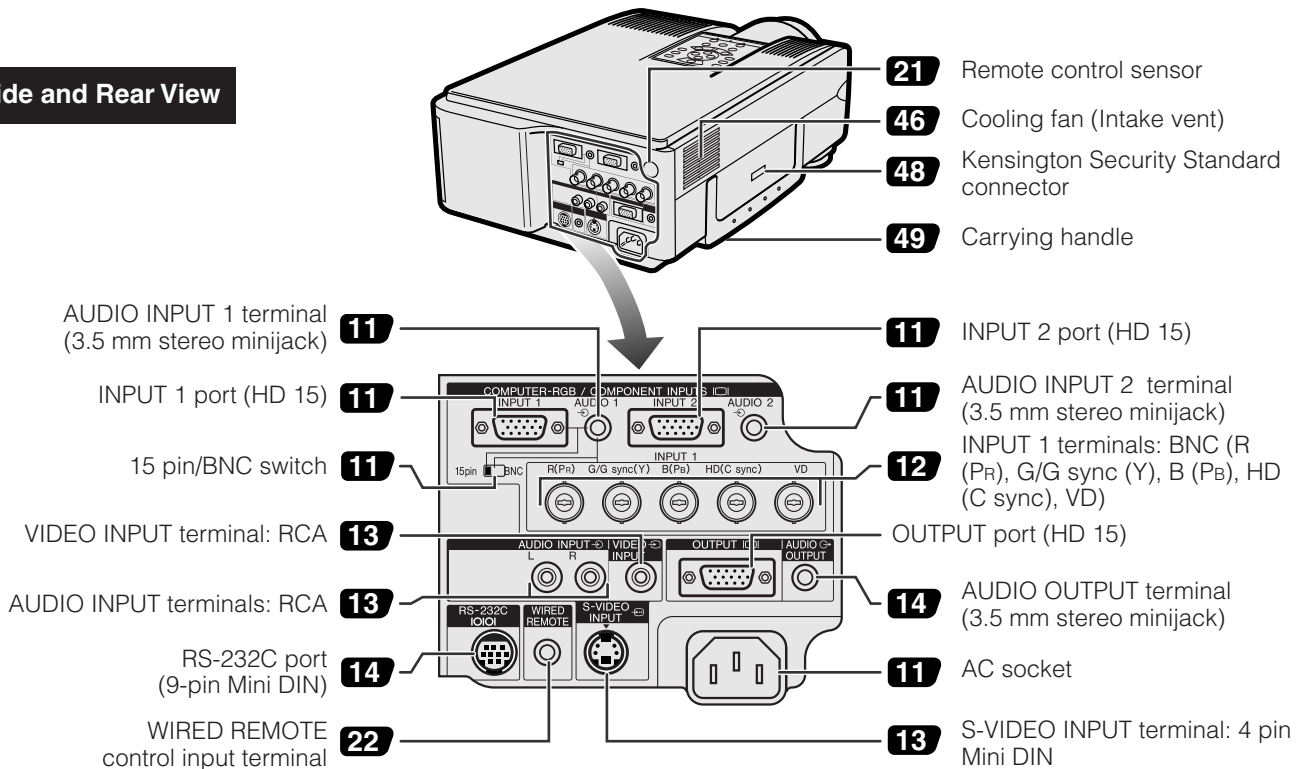



Remote Control

Front View

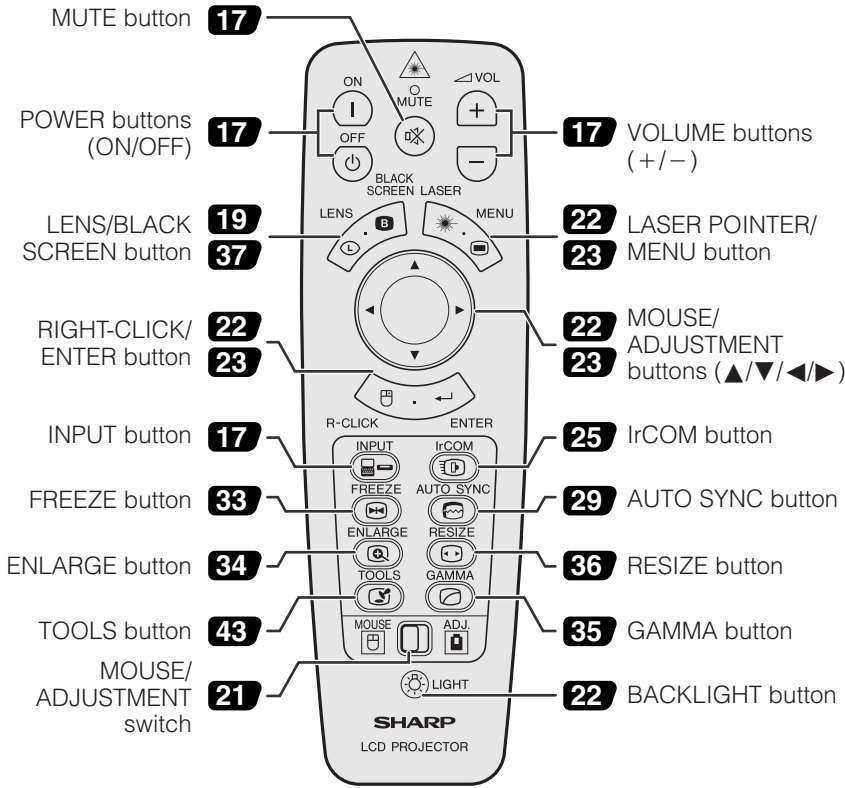

Top View

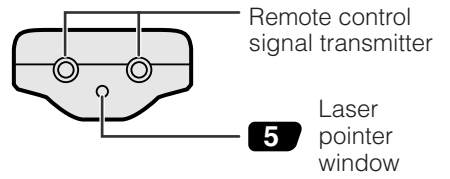

Rear View

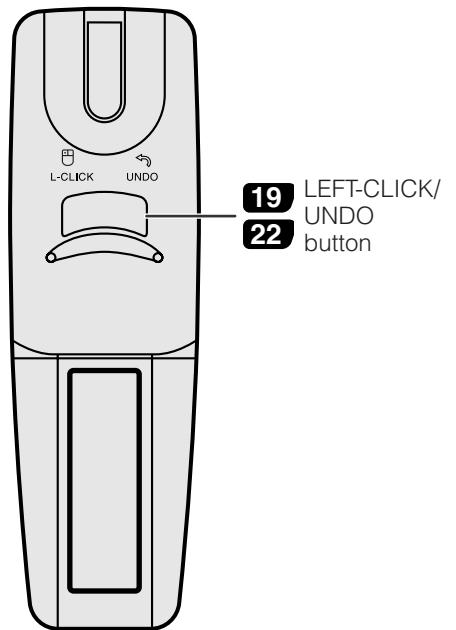

Bottom View



Inserting the batteries

| | | |
|---|---|--|
| <p>1 Press in and downward on the arrow to remove the battery cover.</p> | <p>2 Insert two AA size batteries for the remote control, making sure their polarities match the + and - marks inside the battery compartment.</p> | <p>3 Insert the side tabs of the battery cover into their slots and press the cover in until it is properly seated.</p> |
| <p>Battery cover</p> | <p>Battery compartment</p> | <p>Battery cover</p> |



Setup & Connections

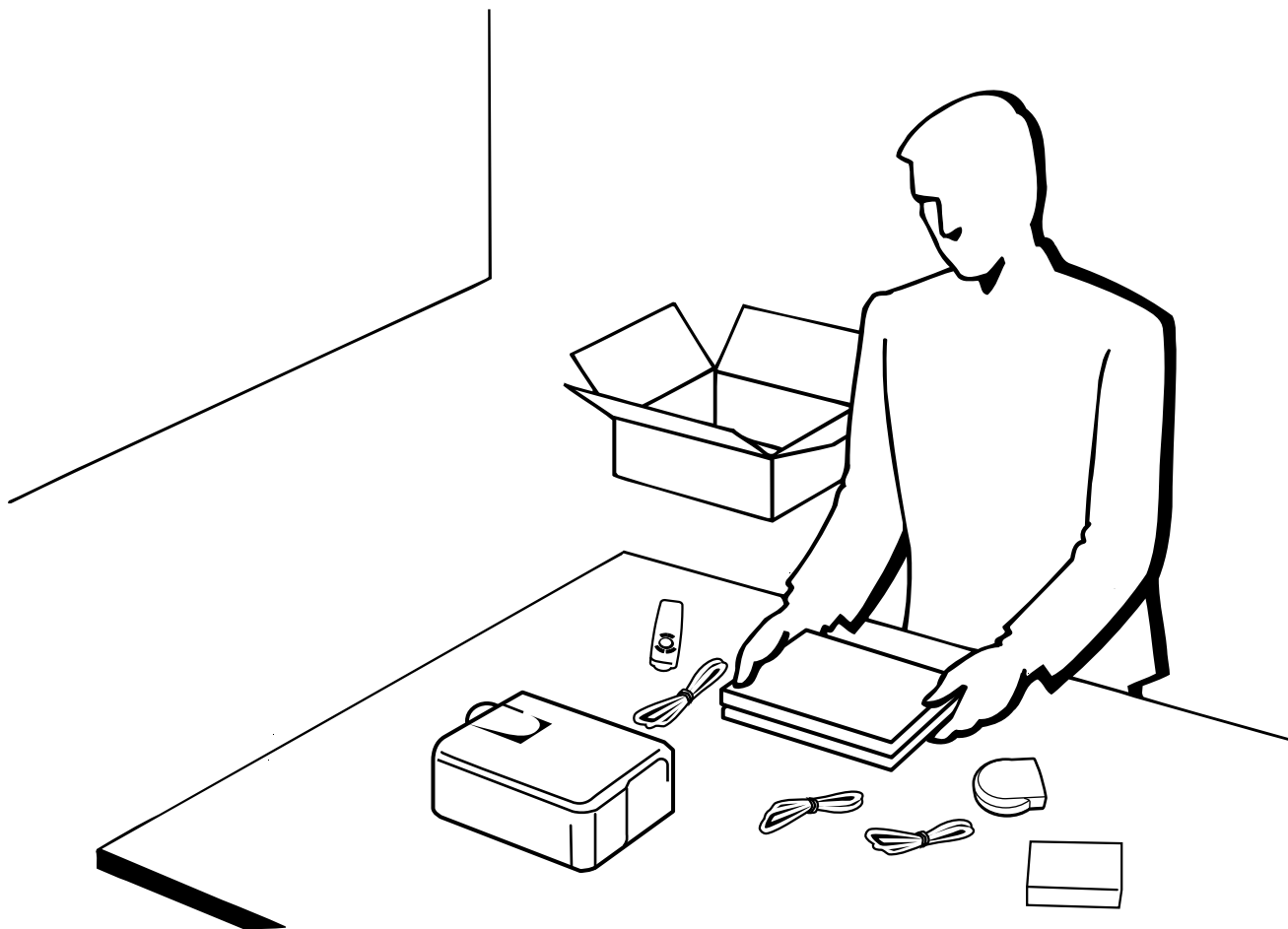

Setting up the Projector

1. Supplied Accessories

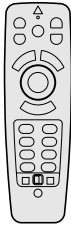

Remote control
RRMCG1547CESA



Two AA size batteries

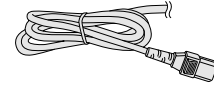

Power cord

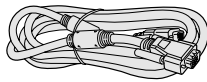

Computer cable
QCNW-5304CEZZ

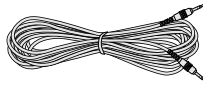

Computer audio cable
QCNW-4870CEZZ



Three BNC-RCA adaptors
QPLGJ0107GEZZ

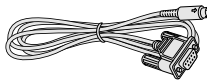

Mouse control
serial cable
QCNW-5112CEZZ

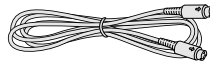

Mouse control
cable for IBM PS/2
QCNW-5113CEZZ

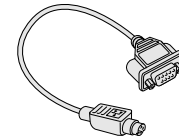

Mouse control cable
for Mac
QCNW-5114CEZZ

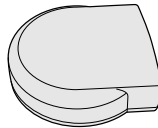

Remote mouse receiver
RUNTK0661CEZZ

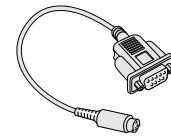

DIN-D-sub RS-232C cable
QCNW-5288CEZZ

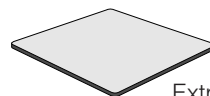
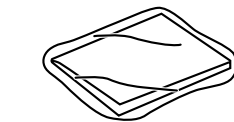

Extra air filter
PFILD0080CEZZ



Lens cap
PCAPH1056CESA

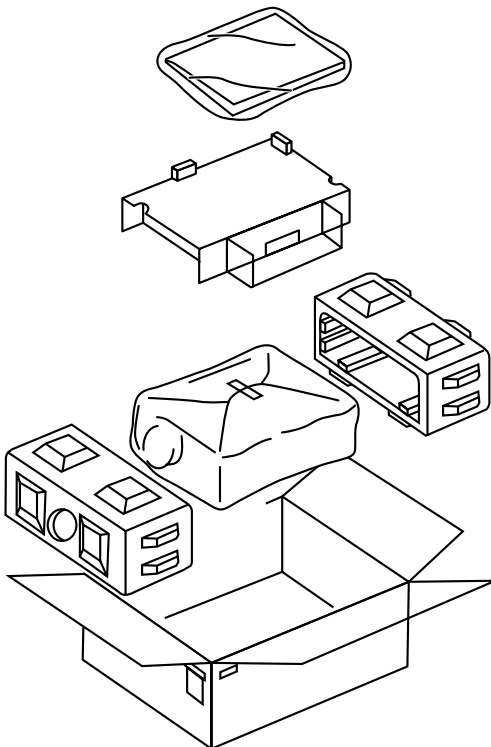

CD-ROM

LCD projector operation manual

LCD projector quick reference

Sharp Advanced Presentation
Software operation manual

Sharp Advanced Presentation
Software quick reference

IrDA driver installation
instruction sheet



2. Connecting the Projector

Connecting the Power Cord

Plug the supplied power cord into the AC socket on the back of the projector.

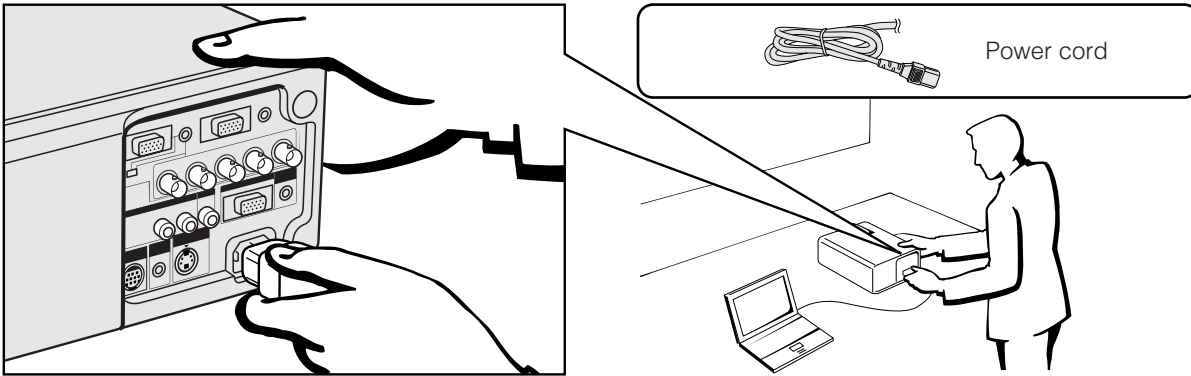

Connecting the Projector to a Computer

You can connect your projector to a computer for projection of full colour computer images.

Connecting an IBM-PC or a Macintosh computer using the standard 15 pin Input

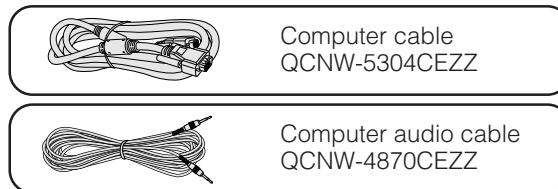
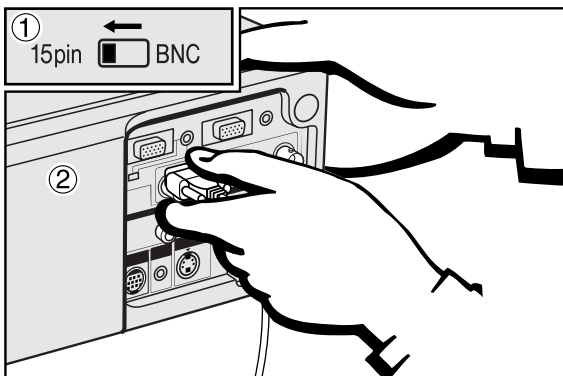

- ① To use the Standard 15-pin connector, slide the 15 pin/ BNC switch on the rear terminals to the 15 pin position.
- ② Connect one end of the supplied computer cable to the COMPUTER-RGB INPUT 1 or 2 port on the projector.
- ③ Connect the other end to the Monitor output port on the computer. Secure the connectors by tightening the thumb screws.
- ④ To use the built-in audio system, connect one end of the supplied computer audio cable to the AUDIO INPUT 1 or 2 terminal on the projector.
- ⑤ Connect the other end to the Audio output terminal on the computer.

CAUTION

- Before connecting, be sure to turn both the projector and the computer off. After making all connections, turn the projector on first. The computer should always be turned on last.

NOTE

- Please read the computer's operation manual carefully.
- Refer to pages 54 and 55 "Input Signals (Recommended Timing)" for a list of computer signals compatible with the projector. Use with computer signals other than those listed may cause some of the functions not to work.

When connecting this projector to a computer, select "Computer/RGB" for "Signal Type" on the GUI menu. (See page 40.)

NOTE

- A Macintosh adaptor may be required for use with some Macintosh computers. Contact your nearest Authorised Sharp Industrial LCD Products Dealer or Service Centre.

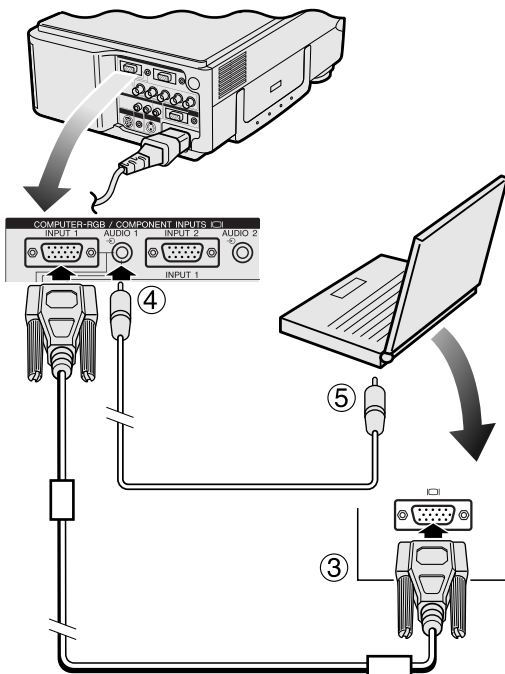

- This projector uses a 5 BNC computer input to prevent deterioration of image quality.
- Connect the R (P_R), G/G sync (Y), B (P_B), HD (C sync) and VD cables to the correct input terminals on the projector and an RGB switcher (sold separately) connected to the computer, or connect a 5 BNC cable (sold separately) directly from the input terminals on the projector to the computer.

Connecting to an external RGB switcher or other compatible computers using the BNC Input (Typically used in larger installations)

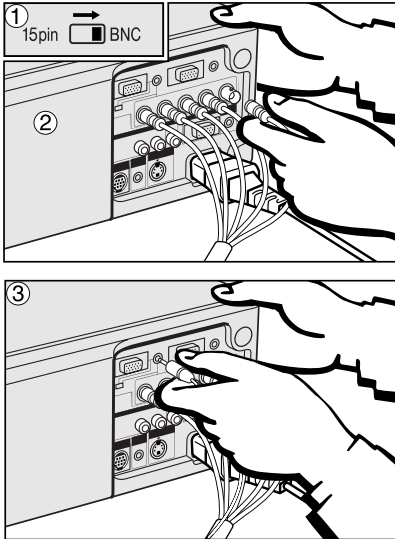

Computer audio cable
QCNW-4870CEZZ

- ① To use the 5 BNC connector, slide the 15 pin/BNC switch on the rear terminals to the BNC position. Connect each BNC connector to the corresponding BNC INPUT 1 terminals on the projector.
- ② Connect the other end of the 5 BNC cable to the corresponding BNC terminals on the external RGB switcher.
- ③ To use the built-in audio system, connect one end of the supplied computer audio cable to the AUDIO INPUT 1 or 2 terminal on the projector.
- ④ Connect the other end to the Audio output terminal on the computer or external audio system.

NOTE

- A 3.5 mm minijack to RCA audio cable adaptor may be necessary.

When connecting the projector to a compatible computer other than an IBM-PC (VGA/SVGA/XGA/SXGA/UXGA) or Macintosh (i.e. Workstation), a separate cable may be needed. Please contact your dealer for more information.

When connecting this projector to a computer, select "Computer/RGB" for "Signal Type" on the GUI menu. (See page 40.)

NOTE

- Connecting computers other than the recommended types may result in damage to the projector, the computer, or both.
- AUDIO INPUT 1 or 2 accepts INPUT 1 or 2 port input.

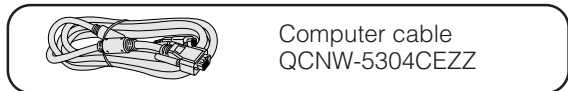
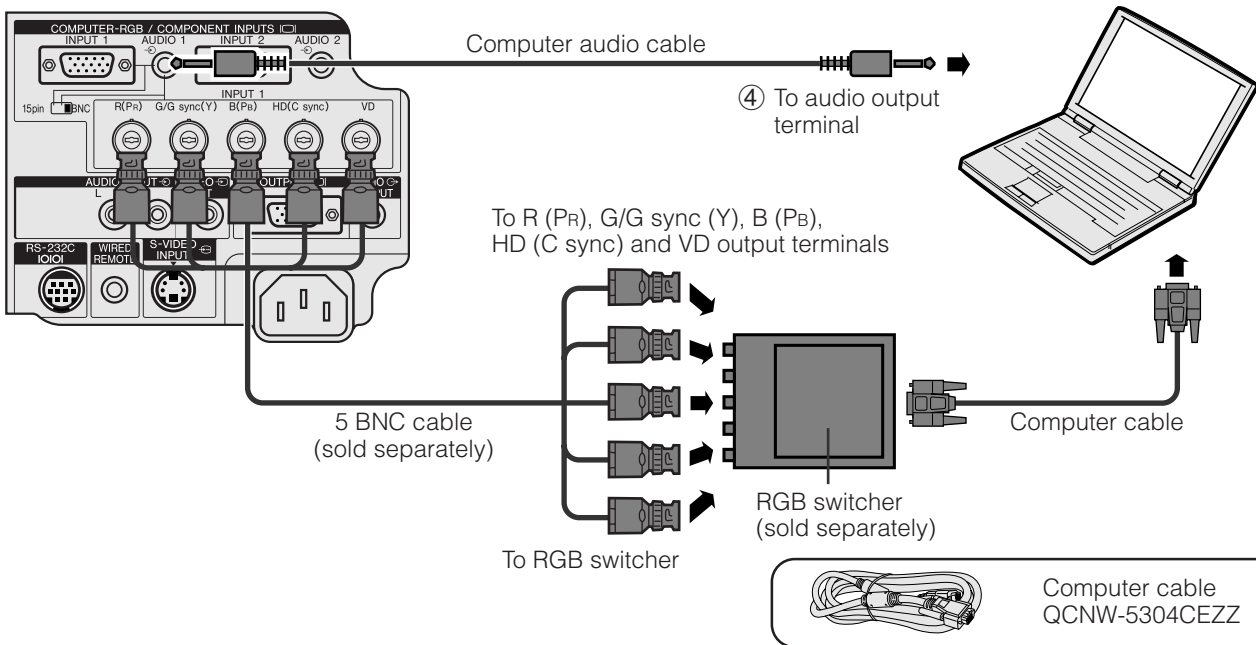

Computer cable
QCNW-5304CEZZ

"Plug and Play" function (when connecting to a 15 pin terminal)

- This projector is compatible with VESA-standard DDC 1/DDC 2B. The projector and a VESA DDC compatible computer will communicate their setting requirements, allowing for quick and easy setup.
- Before using the "Plug and Play" function, be sure to turn on the projector first and the connected computer last.

NOTE

- The DDC, Plug and Play function of this projector operates only when used in conjunction with a VESA DDC compatible computer.

Connecting the Projector to Video Equipment

You can connect your projector to a VCR, laser disc player, DVD player, DTV* decoder and other audiovisual equipment.

CAUTION

- Always turn off the projector while connecting to video equipment, in order to protect both the projector and the equipment being connected.

Connecting a VCR, laser disc player and other audiovisual equipment using the standard video Input

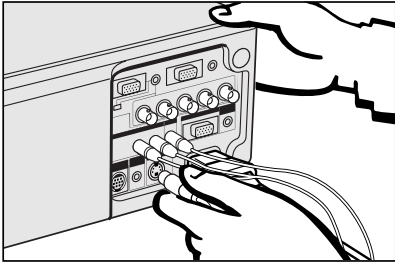

- Connect the yellow RCA connectors to the corresponding yellow VIDEO INPUT terminal on the projector and the Video output terminal on the video source.
- To use the built-in audio system, connect the red and white RCA connectors to the corresponding red and white AUDIO INPUT terminals on the projector and the Audio output terminals on the video source.

The S-VIDEO INPUT terminal uses a video signal system in which the picture is separated into a colour and a luminance signal to realise a higher-quality image.

NOTE

- For higher quality video, you may use the S-VIDEO INPUT terminal on the projector. S-video cable is sold separately.
- If your video equipment does not have an S-video output terminal, use the Composite video output terminal.

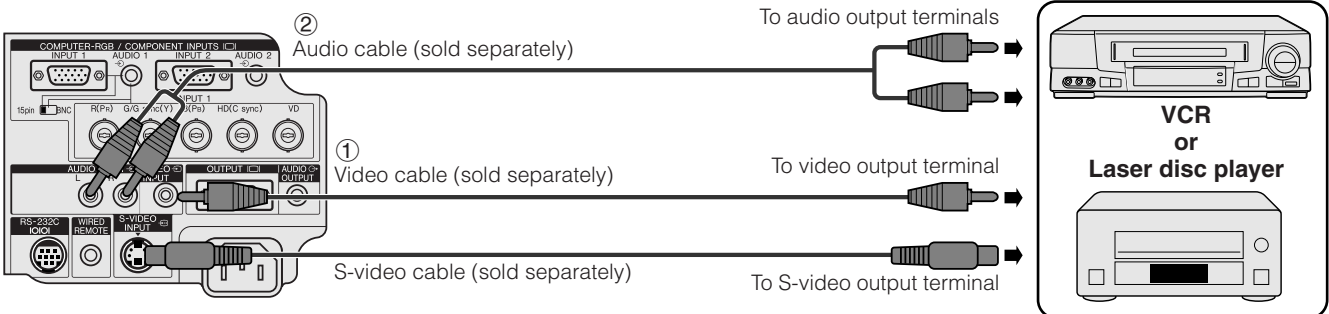

Connecting a DVD player, DTV decoder and other component video equipment using the 5 BNC Input

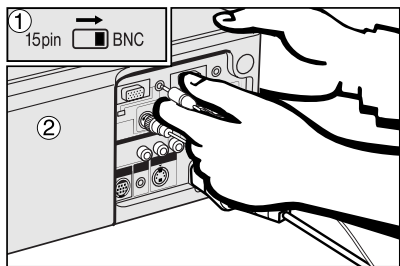

- To use the 5 BNC connector, slide the 15 pin/BNC switch on the rear terminals to the BNC position. Connect each BNC connector to the corresponding BNC INPUT 1 terminals on the projector.

NOTE

- BNC-RCA adaptors are included for use with RCA type cables and sources.
- Connect the other end of the cable to the corresponding terminals of a DVD player or DTV decoder.
 - To use the built-in audio system, connect one end of the supplied computer audio cable to AUDIO INPUT 1 or 2 terminal on the projector. Connect the other end to the Audio output terminal on the computer.

NOTE

- A 3.5 mm minijack to RCA audio cable adaptor may be necessary.

When connecting this projector to a DVD player or a DTV decoder, select "Component" for "Signal Type" on the GUI menu. (See page 40.)

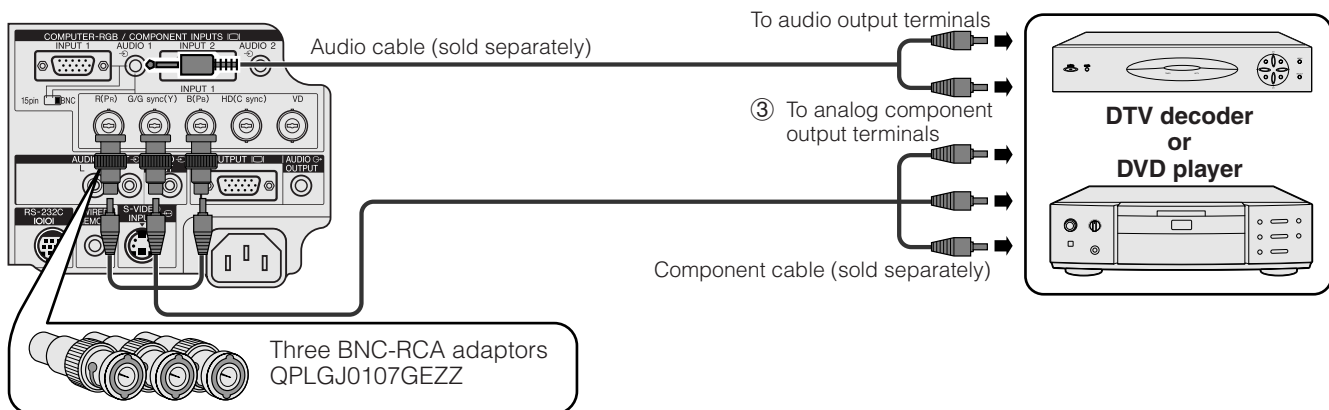

*DTV is the umbrella term used to describe the new digital television system in the united states.

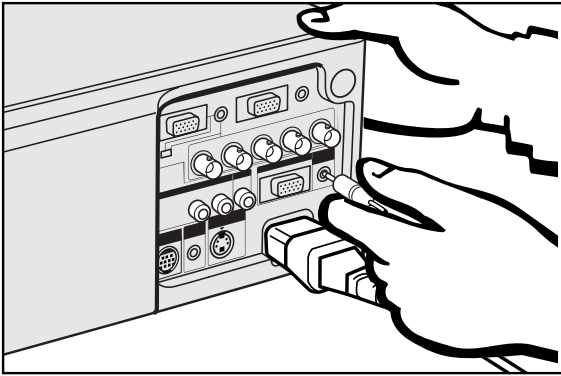

Connecting an amplifier and other audio components

CAUTION

- Always turn off the projector while connecting to audio components, in order to protect both the projector and the components being connected.

NOTE

- By using external audio components, the volume can be amplified for better sound.

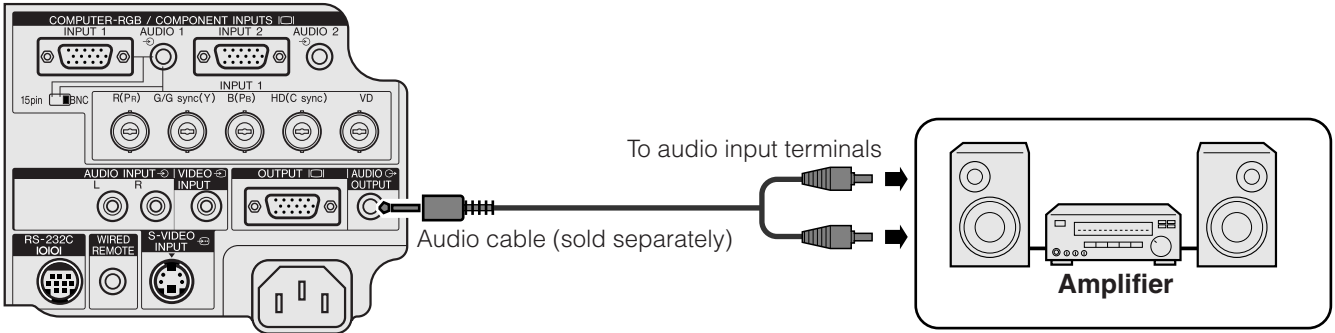

Connecting RS-232C Port

When the RS-232C port on the projector is connected to a computer with an RS-232C cable (cross type, sold separately), the computer can be used to control the projector and check the status of the projector. See pages 51 and 52 for details.

| | |
|--|---------------------------------------|
| | Computer cable QCNW-5304CEZZ |
| | Computer audio cable QCNW-4870CEZZ |

| | |
|--|--|
| | DIN-D-sub RS-232C cable QCNW-5288CEZZ |
|--|--|

- ① Connect the supplied DIN-D-sub RS-232C cable to the RS-232C port on the projector.
- ② Connect a RS-232C cable (sold separately) to the other end of DIN-D-sub RS-232C cable and to the serial port on the computer.

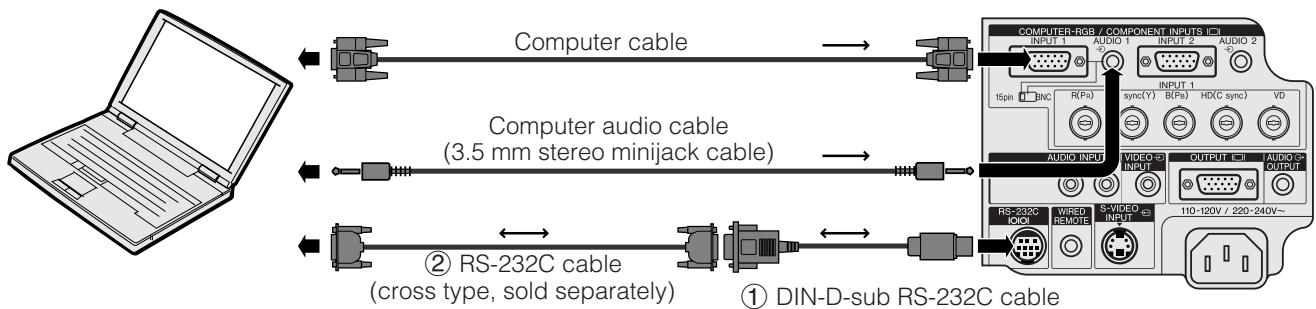

CAUTION

- Do not connect or remove RS-232C cable to or from the computer while it is on. This may damage your computer.

NOTE

- The wireless mouse or RS-232C function may not operate if your computer port is not correctly set up. Please refer to the operation manual of the computer for details on setting up/installing the correct mouse driver.
- The arrows (→, ↔) indicate the direction of the signals.
- A Macintosh adaptor may be required for use with some Macintosh computers. Contact your nearest Authorised Sharp Industrial LCD Products Dealer or Service Centre.

Connecting the Remote Mouse Receiver

- You can use the remote control as a remote mouse.
- When the RS-232C port on the projector is connected to a computer with an RS-232C cable (cross type, sold separately), the computer can be used to control the projector and check the status of the projector. See pages 51 and 52 for details.

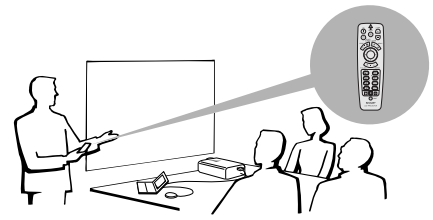

IBM or IBM compatible PC

- ① Connect one end of the supplied mouse control cable to the corresponding terminal on the PC.
- ② Connect the other end to the remote mouse receiver.

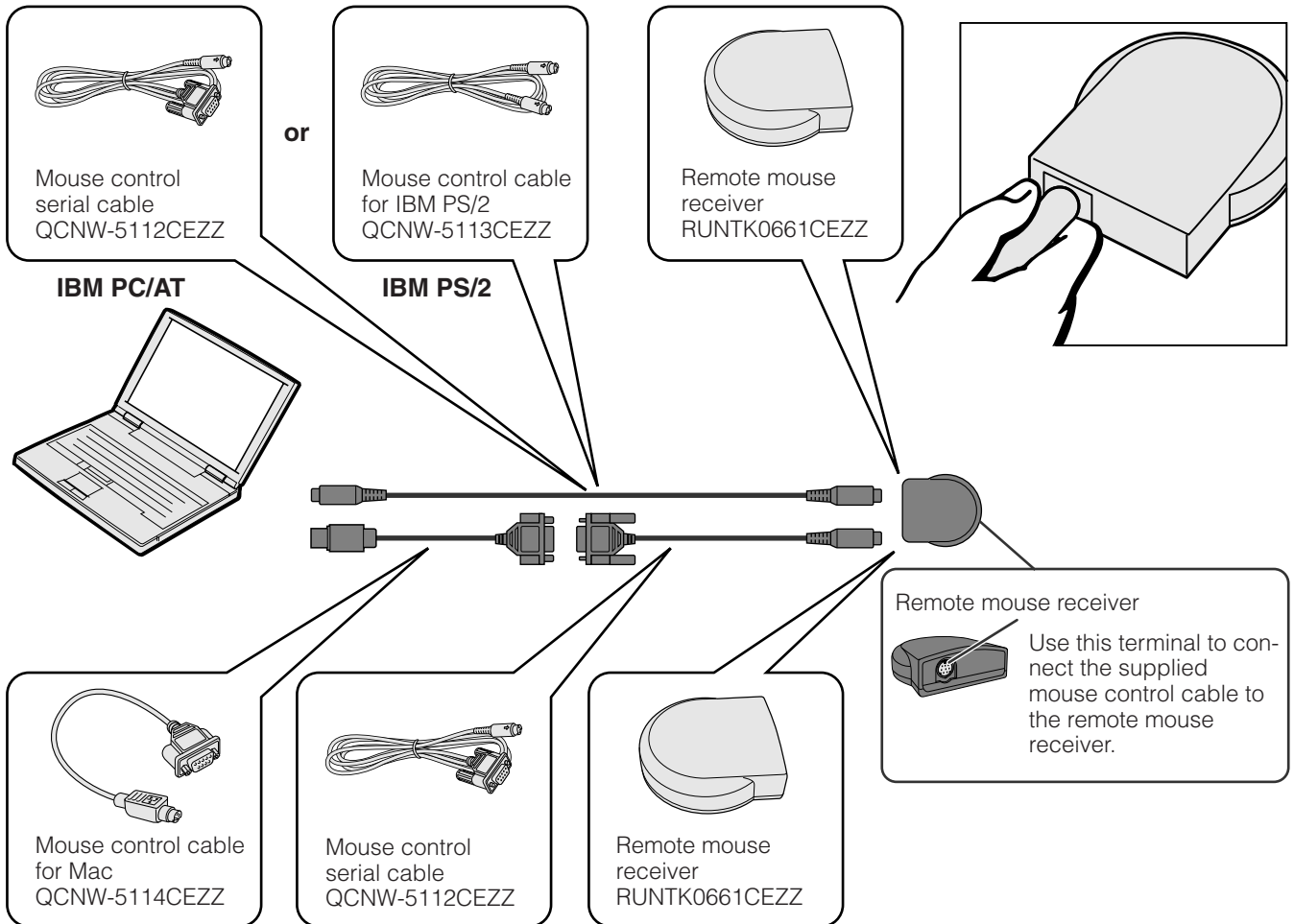

Macintosh

- ① Connect the mouse control serial cable to the remote mouse receiver.
- ② Connect the mouse control cable for Mac to the Mac ADB port on the Mac.
- ③ Connect the other end of the mouse control cable for Mac to the mouse control serial cable.

CAUTION

- Do not connect or remove the mouse control cables to or from the computer while it is on. This may damage your computer.

NOTE

- The wireless mouse functions can operate computers compatible with IBM PS/2, serial (RS-232C) or Apple ADB type mouse systems.

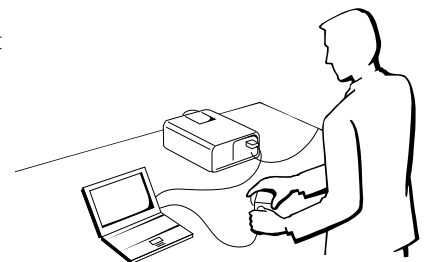



Operation

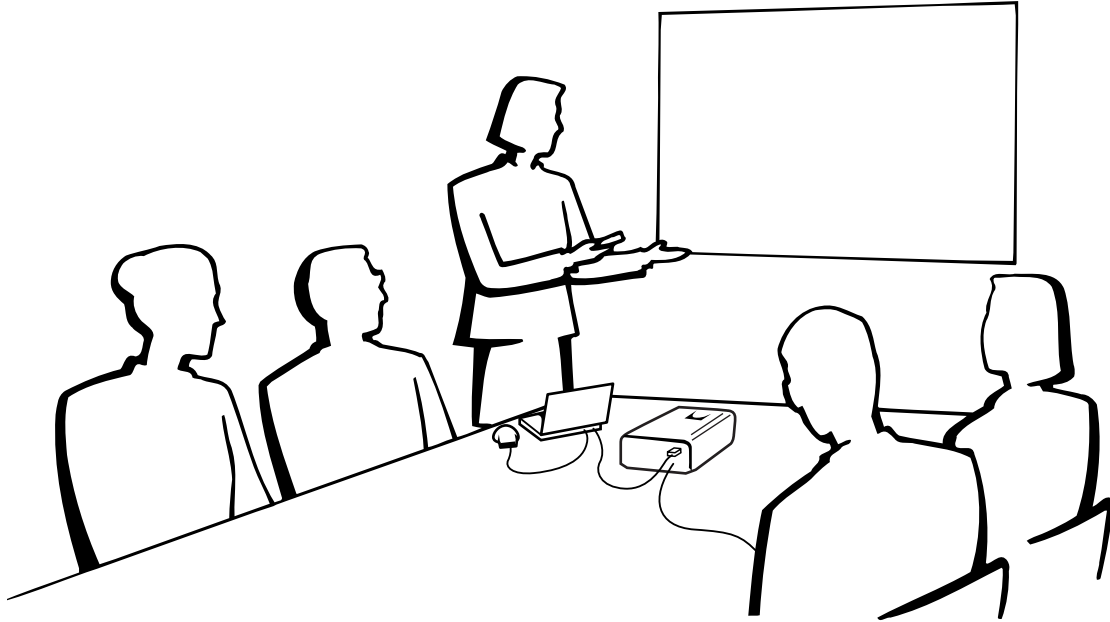

Basic Operations

1. Turning on/off the Power

1

Make the necessary connections before proceeding.
Connect the power cord to a wall outlet.

The POWER indicator lights up red and the projector enters standby mode.

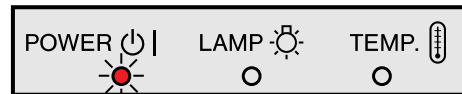

NOTE

- If the bottom filter cover is not securely installed, the POWER indicator flashes.

2

ON
1

Press **Power ON**.

NOTE

- The flashing green LAMP REPLACEMENT indicator shows that the lamp is warming up. Wait until the indicator stops flashing before operating the projector.
- If the power is turned off and then immediately turned on again, it may take a short while before the lamp turns on.
- After the projector is unpacked and turned on for the first time, a slight odour may be emitted from the exhaust vent. This odour will soon disappear with use.

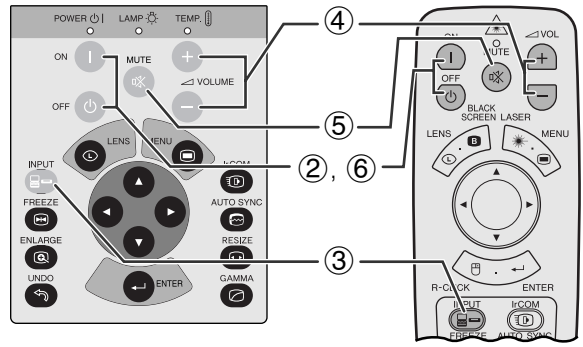

When the power is on, the LAMP REPLACEMENT indicator lights indicating the status of the lamp.

- Green:** Lamp is ready.
- Flashing green:** Warming up.
- Red:** Change the lamp.

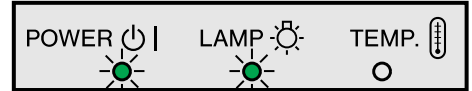

3

INPUT

Press **INPUT** to select the desired input mode. Press **INPUT** again to change the mode.

EXAMPLE

INPUT 1 Mode



INPUT 2 Mode



VIDEO Mode



NOTE

- When no signal is being received, "NO SIGNAL" will be displayed. When a signal that the projector is not preset to receive is being received, "NOT REG." will be displayed.

4

VOL
+
-

Press **VOLUME +/-** to adjust the volume.

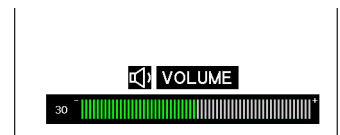

5

MUTE

Press **MUTE** to temporarily turn off the sound. Press **MUTE** again to turn the sound back on.



6

OFF

Press **POWER OFF**. Press **POWER OFF** again while the message is displayed.



NOTE

- If you accidentally pressed **POWER OFF** and do not want to turn off the power, wait until the power off screen disappears.
- When **POWER OFF** is pressed twice, the POWER indicator will light up red and the cooling fan will run for about 90 seconds. The projector will then enter standby mode.
- Wait until the cooling fan stops before disconnecting the power cord.
- The power can be turned on again by pressing **POWER ON**. When the power is turned on, the POWER indicator and the LAMP REPLACEMENT indicator light green.
- The POWER indicator flashes if the bottom filter cover is not securely installed.

2. Setting up the Screen

Position the projector perpendicular to the screen with all feet flat and level to achieve an optimal image. Move the projector forward or backward if the edges of the image are distorted.

NOTE

- The projector lens should be centred in the middle of the screen. If the lens centre is not perpendicular to the screen, the image will be distorted, making viewing difficult.
- Position the screen so that it is not in direct sunlight or room light. Light falling directly onto the screen washes out colours, making viewing difficult. Close the curtains and dim the lights when setting up the screen in a sunny or bright room.
- A polarising screen cannot be used with this projector.

Standard Setup (Front Projection)

Place the projector at the required distance from the screen according to the desired picture size (see the table below).

NOTE

- Optional wide and telephoto lenses from Sharp are available for specialised application. Please see your local Authorised Sharp Industrial LCD Products Dealer for details on the AN-T6EZ and AN-W6EZ lenses.

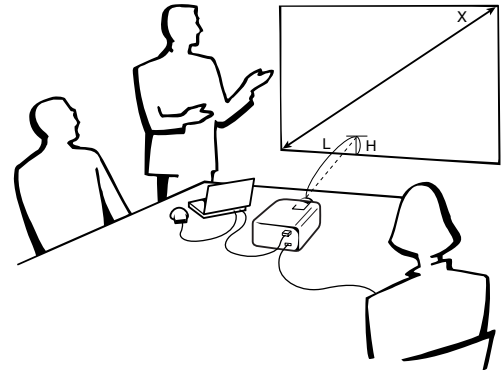

NORMAL Mode (4:3)

| Picture size (diag.) (X) | Projection distance (L) | | Distance from the lens centre to the bottom of the image (H) |
|--------------------------|-------------------------|---------|--|
| | Maximum | Minimum | |
| 762 cm (300") | 14.3 m | 11.0 m | 22.9 cm |
| 508 cm (200") | 9.8 m | 7.4 m | 15.2 cm |
| 381 cm (150") | 7.2 m | 5.6 m | 11.4 cm |
| 254 cm (100") | 4.9 m | 3.7 m | 7.6 cm |
| 213 cm (84") | 4.0 m | 3.1 m | 6.4 cm |
| 183 cm (72") | 3.4 m | 2.6 m | 5.5 cm |
| 152 cm (60") | 2.9 m | 2.2 m | 4.6 cm |
| 102 cm (40") | 1.9 m | 1.4 m | 3.1 cm |

WIDE Mode (16:9)

| Picture size (diag.) (X) | Projection distance (L) | | Distance from the lens centre to the bottom of the image (H) |
|--------------------------|-------------------------|---------|--|
| | Maximum | Minimum | |
| 762 cm (300") | 15.6 m | 12.0 m | -37.4 cm |
| 508 cm (200") | 10.5 m | 8.1 m | -24.9 cm |
| 381 cm (150") | 7.9 m | 6.1 m | -18.7 cm |
| 338 cm (133") | 7.0 m | 5.4 m | -16.6 cm |
| 269 cm (106") | 5.6 m | 4.3 m | -13.2 cm |
| 254 cm (100") | 5.2 m | 4.0 m | -12.5 cm |
| 234 cm (92") | 4.8 m | 3.7 m | -11.5 cm |
| 213 cm (84") | 4.3 m | 3.3 m | -10.5 cm |
| 183 cm (72") | 3.7 m | 2.8 m | -9.0 cm |
| 152 cm (60") | 3.1 m | 2.4 m | -7.5 cm |
| 102 cm (40") | 2.0 m | 1.5 m | -5.0 cm |

NOTE

- Values with a minus (-) sign indicate the distance of the lens centre below the bottom of the screen.

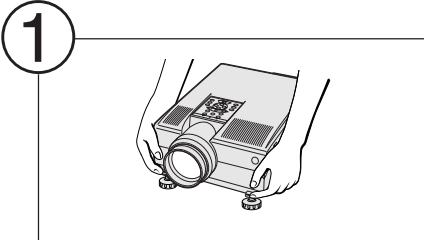

Using the Adjustment Feet

- 

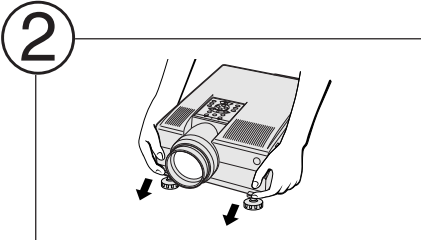
1 Press foot releases.
- 

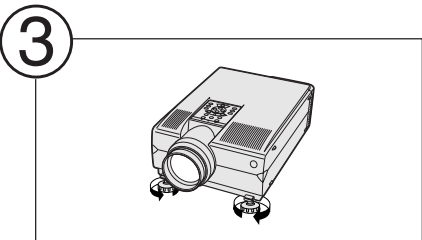
2 Adjust height of projector and remove hands from foot releases.
- 

3 Rotate feet to make minor changes.

NOTE

- The projector is adjustable up to approximately 5° from the standard position.
- When the height of the projector is adjusted, the image may become distorted (keystoned), depending on the relative positions of the projector and the screen.

CAUTION

- Do not press the foot releases when the adjustment feet are extended without firmly holding the projector.
- Do not hold the lens when lifting or lowering the projector.
- When lowering the projector, be careful not to get your fingers caught in the area between the adjustment feet and the projector.

Digital Lens Adjustment

1 **LENS** Press **LENS** to select mode. Each time **LENS** is pressed, the screen changes in the following order.

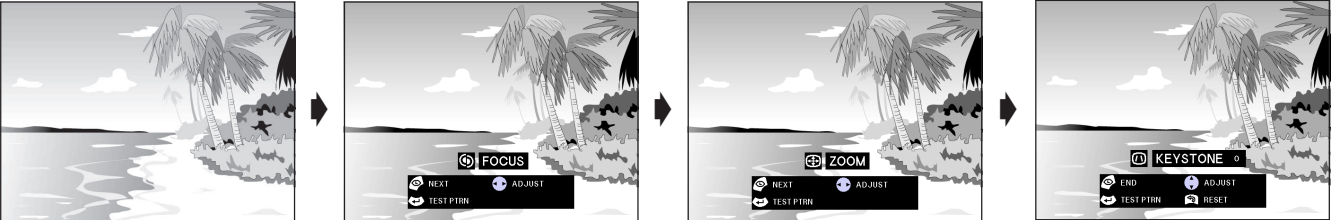

Projector

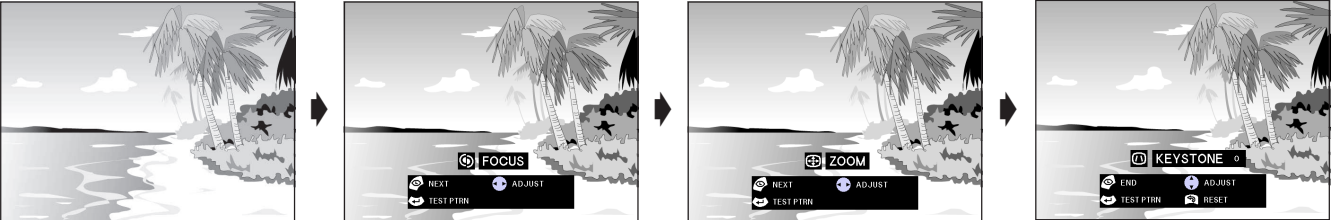

Remote control

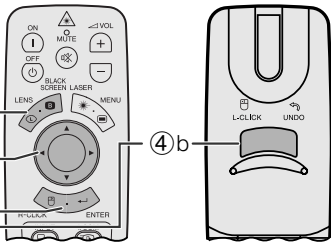

- 2** **ENTER** Press **ENTER** to display test pattern.
- 3**  Press **▲/▼/◀/▶** to make adjustments.
- 4** **LENS** a. Press **LENS** until normal screen appears.
UNDO b. To reset the **KEYSTONE** setting, press **UNDO**.

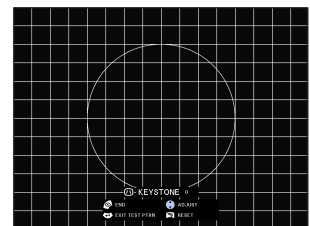

NOTE

- Straight lines and the edges of the displayed image may appear jagged, when adjusting the **KEYSTONE** setting.
- Do not touch the lens when adjusting the focus or zoom.

Reversed Image Setup

Rear projection

- Place a translucent screen between the projector and the audience.
- Use the projector's menu system to reverse the projected image. (See page 42 for use of this function.)

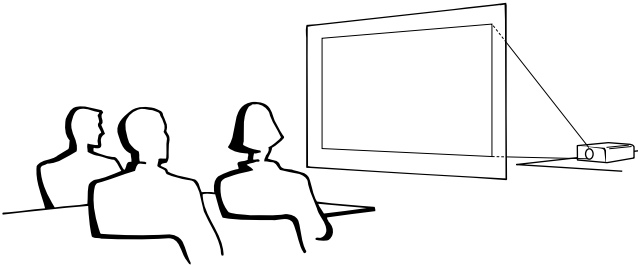

Projection using a mirror

- Place a mirror (normal flat type) in front of the lens.
- Use the projector's menu system to reverse the projected image. (See page 42 for use of this function.)
- The image reflected from the mirror is projected onto the screen.

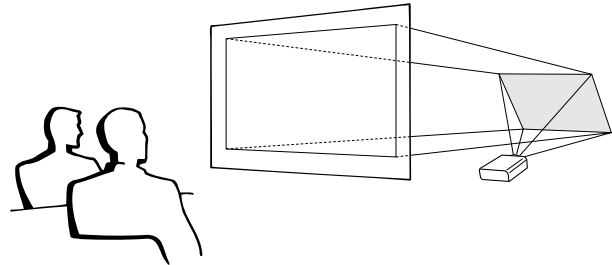

NOTE

- Optimal image quality is produced with the projector positioned perpendicular to the screen with all feet flat and level.

CAUTION

- When using a mirror, be sure to carefully position both the projector and the mirror so the light does not shine into the eyes of the audience.

Ceiling-mount Setup

- It is recommended that you use the optional Sharp ceiling-mount bracket for this installation.
- Before mounting the projector, contact your nearest Authorised Sharp Industrial LCD Products Dealer or Service Centre to obtain the recommended ceiling-mount bracket (sold separately). (AN-NV6T ceiling-mount bracket, AN-TK201/AN-TK202 extension tube for AN-NV6T.)
- When the projector is in the inverted position, use the upper edge of the screen as the base line.
- Use the projector's menu system to select the appropriate projection mode. (See page 42 for use of this function.)

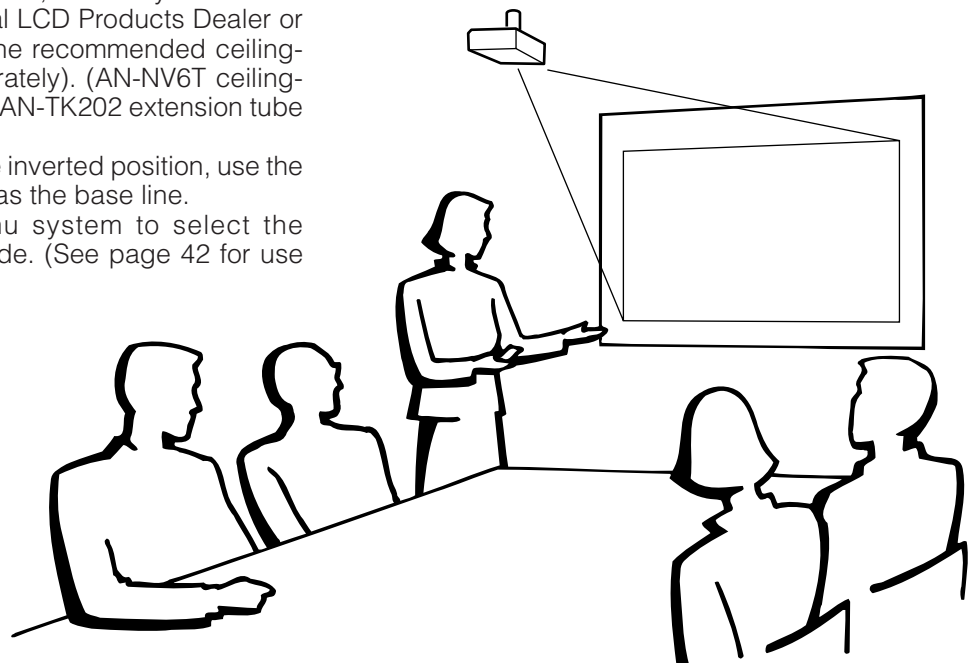

3. Operating the Wireless Mouse from the Remote Control

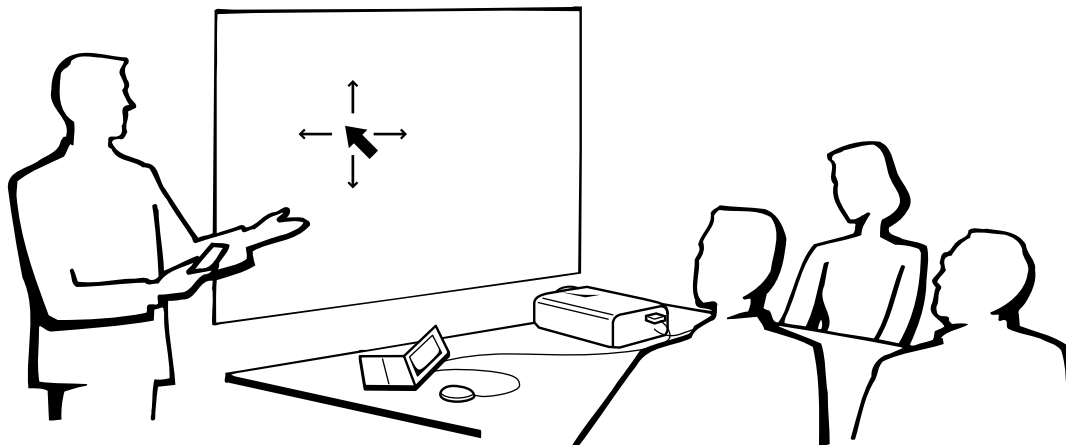

Using the Remote Control as a Wireless Mouse

The remote control has the following three functions:

- Projector control
- Wireless mouse
- Laser pointer

MOUSE/ADJUSTMENT switch (Remote control)

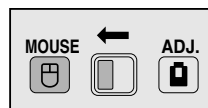

Wireless mouse
Laser pointer

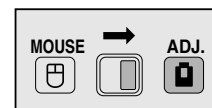

Projector control

Remote Control/Mouse Receiver Positioning

- The remote control can be used to control the projector within the ranges shown below.
- The remote mouse receiver can be used with the remote control to control the mouse functions of a connected computer within the ranges shown below.

NOTE

- The signal from the remote control can be reflected off a screen for easy operation. However, the effective distance of the signal may differ due to the screen material.

Controlling the Projector

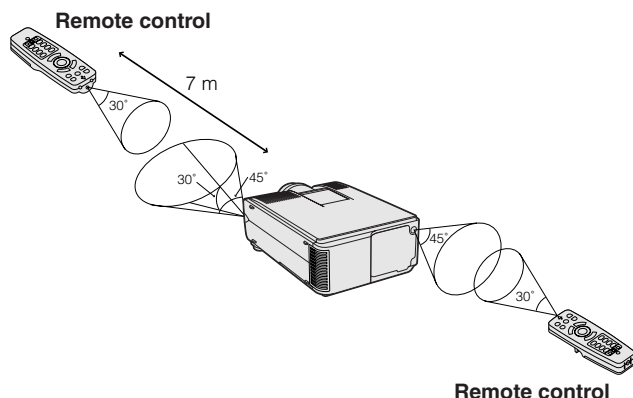

Using the Wireless Mouse

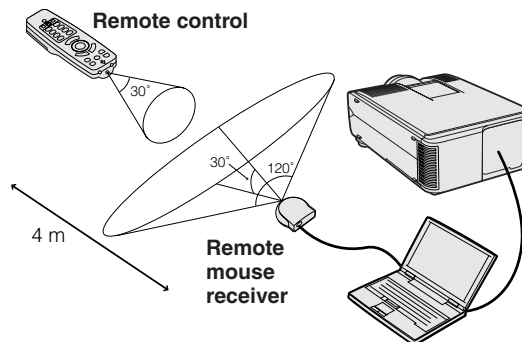

Use as a Wireless Mouse

1



Be sure the supplied remote mouse receiver is connected to your computer.

Slide the **MOUSE/ADJUSTMENT** switch to **MOUSE**.

Effective buttons in **MOUSE** mode

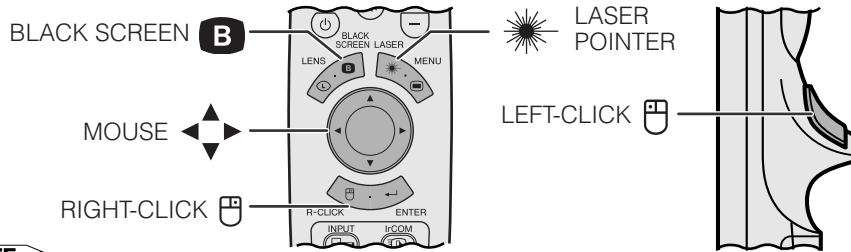

NOTE

- The wireless mouse may not operate correctly if your computer serial port is not correctly set up. Refer to the computer's operation manual for details of setting up/installing the mouse driver.
- For one-button mouse systems, use either the **LEFT-CLICK** or **RIGHT-CLICK** button.



Using the remote control in a dark room

Press **BACKLIGHT**, and the buttons will light up. Green lights refer to mouse operations, and red lights to projector adjustments.

| Button name | Position of MOUSE/ADJUSTMENT switch | |
|--------------------|--|----------------------|
| | MOUSE (M) | ADJ. (A) |
| LASER POINTER/MENU | LASER POINTER (GREEN) | MENU (RED) |
| BLACK SCREEN/LENS | BLACK SCREEN (GREEN) | LENS (RED) |
| RIGHT-CLICK/ENTER | RIGHT-CLICK (GREEN) | ENTER (RED) |
| MOUSE/ADJUSTMENT | MOUSE (NOT LIT) | ADJUSTMENT (NOT LIT) |
| LEFT-CLICK/UNDO | LEFT-CLICK (NOT LIT) | UNDO (NOT LIT) |
| POWER ON/OFF | ON (RED) | |
| VOLUME +/- | | |
| MUTE | | |

| Button name | Position of MOUSE/ADJUSTMENT switch | |
|-------------|--|-----------------|
| | MOUSE (M) | ADJ. (A) |
| INPUT | ON (RED) | |
| IrCOM | | |
| FREEZE | | |
| AUTO SYNC | | |
| ENLARGE | | |
| RESIZE | | |
| TOOLS | | |
| GAMMA | | |

Use as a Laser pointer

1



Slide the **MOUSE/ADJUSTMENT** switch to **MOUSE**.

2



Press **LASER POINTER** (☀) to activate the laser pointer. When the button is released, the light automatically goes off.

NOTE

- For safety, the laser pointer automatically goes off after 1 minute of continuous use. To turn it on, release **LASER POINTER** (☀) and press again.

Wired Remote Control

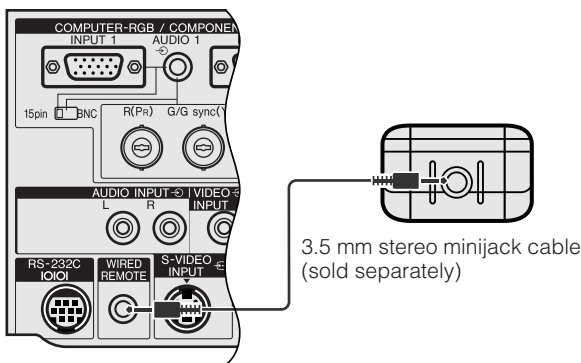

When the remote control cannot be used due to the range or positioning of the projector (rear projection, etc.), connect a 3.5 mm stereo minijack cable (sold separately) from the wired remote control input on the bottom of the remote control to the **WIRED REMOTE** control input terminal on the rear of the projector.

NOTE

- The laser pointer and wireless mouse functions can still be operated with the wired remote control.



Using the GUI (Graphical User Interface) Menu Screens

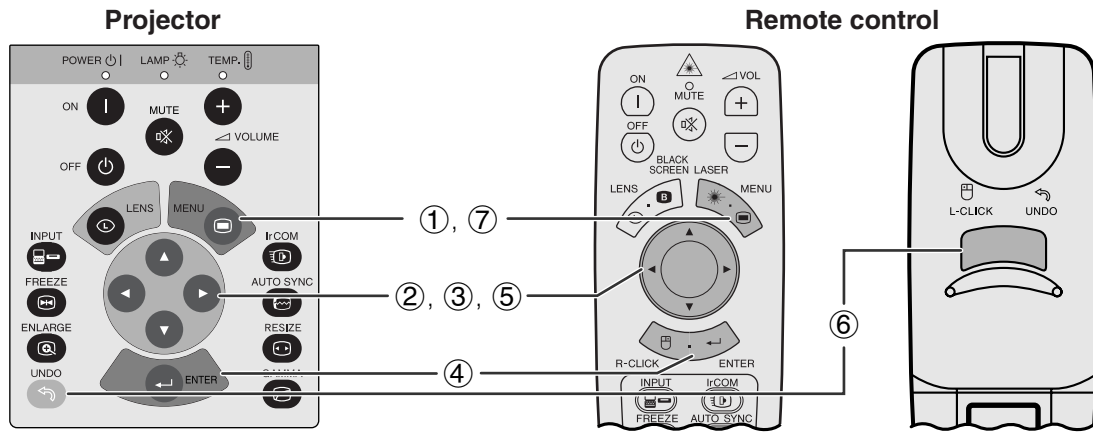

This projector has two sets of menu screens (INPUT/VIDEO) that allow you to adjust the image and various projector settings. These menu screens can be operated from the projector or the remote control with the following buttons.

(GUI) On-screen Display

INPUT (COMPUTER/RGB) mode

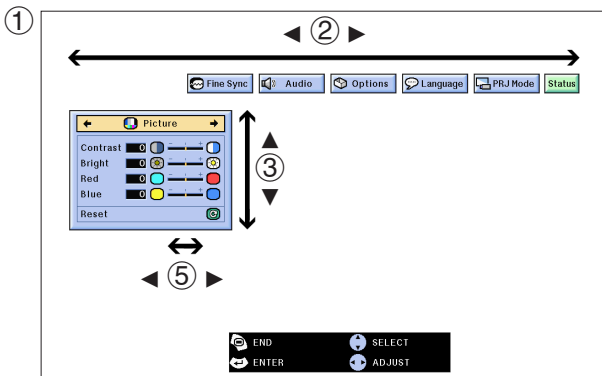

VIDEO mode

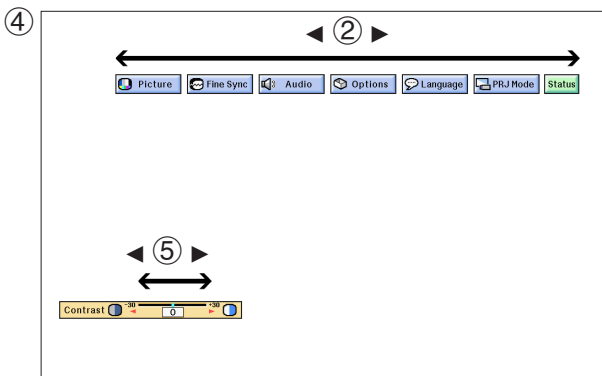
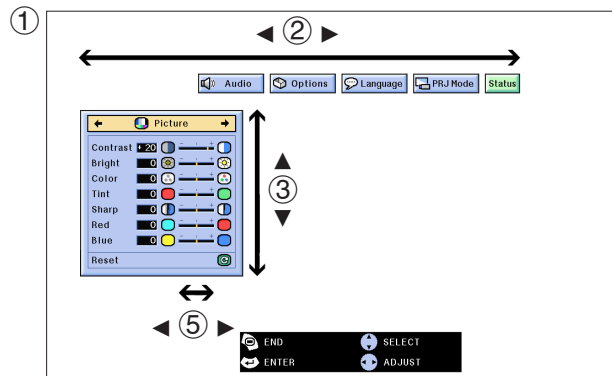

(Slide the **MOUSE/ADJUSTMENT** switch on the remote control to the ADJ. position.)

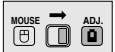

- ① Press **MENU** to display the INPUT or VIDEO mode menu bar.
- ② Press **◀/▶** to select an adjustment menu on the menu bar.
- ③ Press **▲/▼** to select a specific adjustment item.
- ④ To display a single adjustment item, press **ENTER** after selecting the item. Only the menu bar and the selected adjustment item will appear.
- ⑤ Press **◀/▶** to adjust the item.
- ⑥ Press **UNDO** to return to the previous screen.
- ⑦ Press **MENU** to exit from the GUI.

NOTE

- For details on items on the menu screen, see the tree charts on the next page.



Items on the INPUT1 or INPUT2 Mode Menu Bar

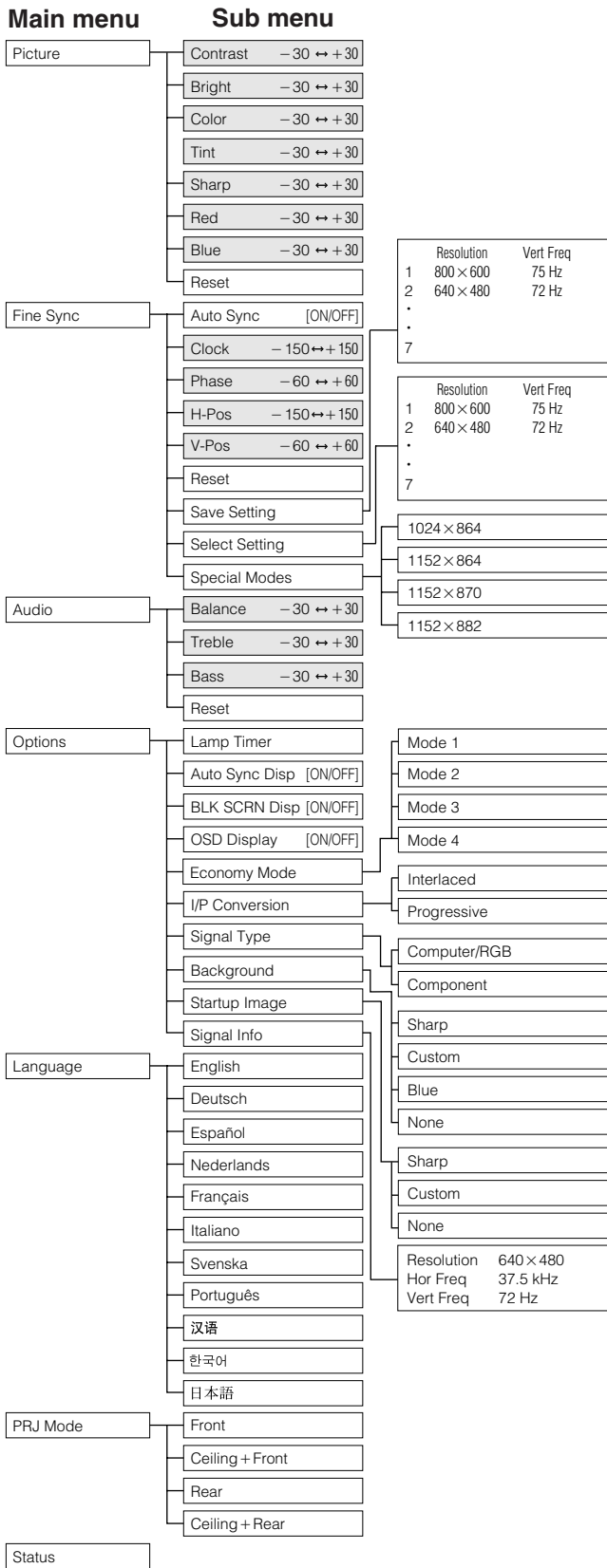

Items on the VIDEO Mode Menu Bar

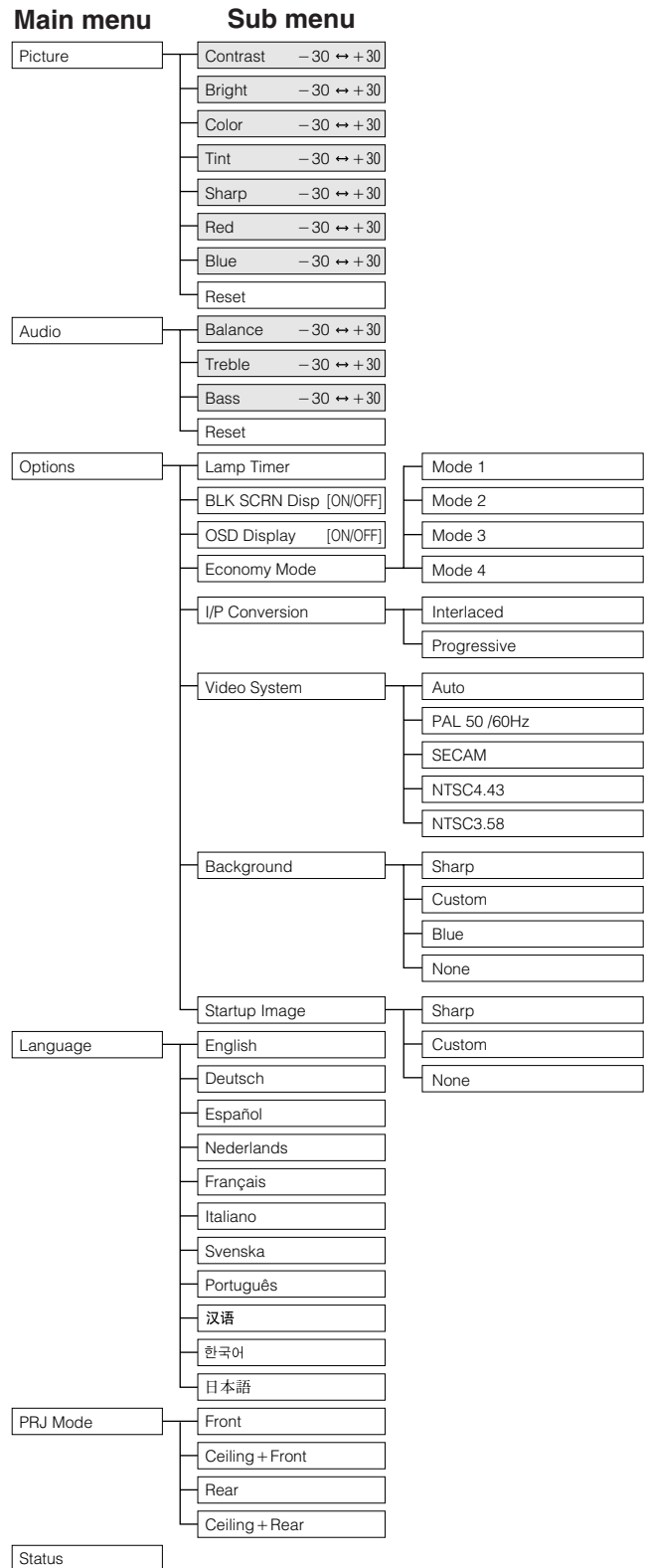

NOTE

- The resolution, vertical frequency and horizontal frequency figures displayed above are for example purposes only.
- “Color”, “Tint”, and “Sharp” appear only when Component input is selected in INPUT mode.
- Only the items highlighted in the tree charts above can be adjusted.
- To adjust the items under the sub menu, press ► after selecting the sub menu.





Using IrCOM for Wireless Presentations

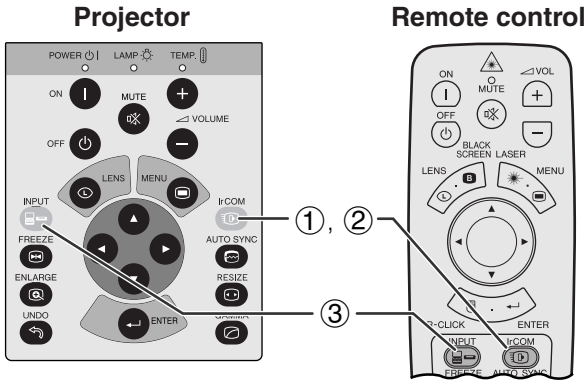

IrCOM1

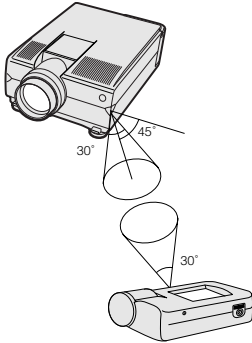

Digital camera

IrCOM2

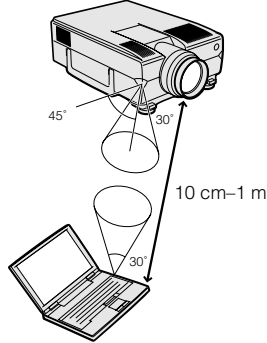

PC

On-screen Display

①



②



The IrCOM function can transfer still images from a computer or digital camera to the projector via infrared (wireless) communication.

Sharp Advanced Presentation Software

- This function requires the supplied Sharp Advanced Presentation Software (SAPS).
- Install the SAPS in the supplied CD-ROM on the computer.
- See the operation manual of the software for installation and operating instructions.
- Position the projector and the IrCOM transmitting device within the range shown on the left.

NOTE

- To avoid transmission errors or changes in the image, ensure the following when setting up the projector and transmitting device.
 - The IrCOM sensors on both the projector and transmitting device are protected from direct sunlight or strong ambient light.
 - The transmitting device has sufficient battery power.
 - The projector and transmitting device are positioned within the designated operating range.
 - The IrCOM sensors on the projector and transmitting device are correctly aligned.
- The distance between the projector and transmitting device may have to be less than 10 cm depending on the transmitting device.
- When using the digital still camera, set it to the image transmission mode and set the computer to the image reception mode.
- Align the projector and transmitting device at the same height and angle at a distance of 10 cm to 1 meter with an unobstructed line of view.

(Slide the **MOUSE/ADJUSTMENT** switch on the remote control to the ADJ. position.)

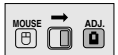

- ① Press **IrCOM** to enter the IrCOM mode. Each time **IrCOM** is pressed, the On-screen Display switches between "Ir-COM1" and "Ir-COM2".
- ② And then the On-screen Display changes as shown on the left.

NOTE

- If the On-screen Display does not change as shown on the left, the projector may not be within the reception range from the IrCOM transmitting device.

- ③ Press **INPUT** to exit the IrCOM mode.

NOTE

- If the projector is unable to receive images from the IrCOM transmitting device, the On-screen display on the left will appear.



Selecting the On-screen Display Language

Projector

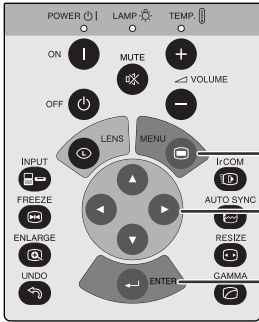

Remote control

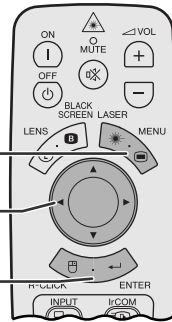

English is the preset language for the On-screen Display. It can be changed to English, German, Spanish, Dutch, French, Italian, Swedish, Portuguese, Chinese, Korean or Japanese.

(Slide the **MOUSE/ADJUSTMENT** switch on the remote control to the ADJ. position.)



- ① Press **MENU**.
- ② Press **◀/▶** to select "Language".
- ③ Press **▲/▼** to select the desired language .
- ④ Press **ENTER** to save the setting. The On-screen Display is now programmed to display in the language selected.
- ⑤ To exit from the GUI, press **MENU**.

(GUI) On-screen Display

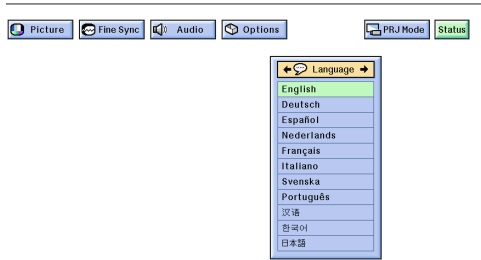

Selecting the Video Input System Mode (VIDEO mode only)

Projector

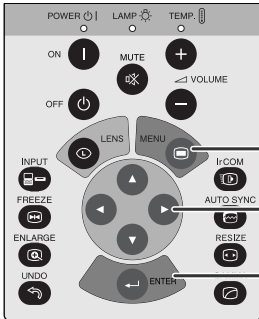

Remote control

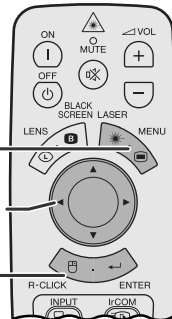

The video input system mode is preset to "Auto"; however, it can be changed to a specific system mode, if the selected system mode is not compatible with the connected audiovisual equipment.

(Slide the **MOUSE/ADJUSTMENT** switch on the remote control to the ADJ. position.)

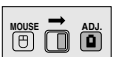

- ① Press **MENU**.
- ② Press **◀/▶** to select "Options".
- ③ Press **▲/▼** to select "Video System", and then press **▶**.
- ④ Press **▲/▼** to select the desired video system mode.
- ⑤ Press **ENTER** to save the setting.
- ⑥ To exit from the GUI, press **MENU**.

(GUI) On-screen Display

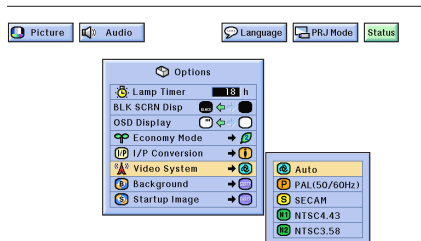

NOTE

- When the system mode is set to "Auto", you may not receive a clear picture due to signal differences. Should this occur, switch to the video system you are viewing.



Picture Adjustments

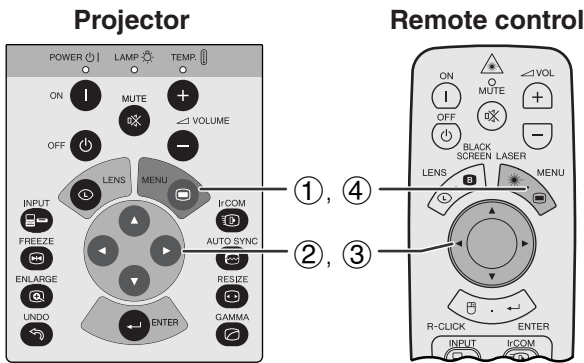

You can adjust the projector's picture to your preferences with the following picture settings.

Description of Adjustment Items

| Selected item | ◀ button | ▶ button |
|-----------------|---|----------------------------|
| Contrast | For less contrast | For more contrast |
| Bright | For less brightness | For more brightness |
| Color | For less colour intensity | For more colour intensity |
| Tint | Skin tones become purplish | Skin tones become greenish |
| Sharp | For less sharpness | For more sharpness |
| Red | For weaker red | For stronger red |
| Blue | For weaker blue | For stronger blue |
| Reset | All image adjustment items are returned to the factory preset settings. | |

(GUI) On-screen Display (COMPUTER/RGB input in INPUT mode)

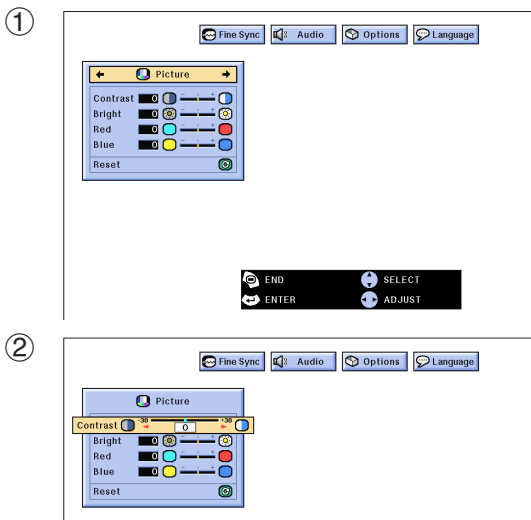

NOTE

- “Color”, “Tint” and “Sharp” do not appear for COMPUTER/RGB input in INPUT mode.

(Slide the **MOUSE/ADJUSTMENT** switch on the remote control to the ADJ. position.)

- ① Press **MENU**. Menu bar and “Picture” menu screen appear. GUI operation guide is also displayed.

- ② Press ▲/▼ to select a specific adjustment item.

- ③ Press ◀/▶ to move the ● mark of the selected adjustment item to the desired setting.

- ④ To exit from the GUI, press **MENU**.

NOTE

- To reset all adjustment items, select “Reset” on the “Picture” menu screen and press **ENTER**.
- The adjustments can be stored separately in the “INPUT 1”, “INPUT 2” and “VIDEO” modes.
- For COMPONENT input in INPUT mode, “Sharp” is adjustable only when a DVD player is connected.



Audio Adjustments

Projector

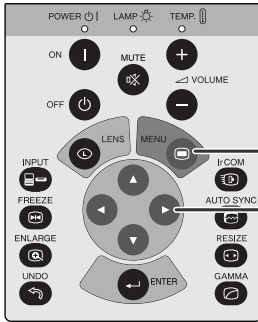

Remote control

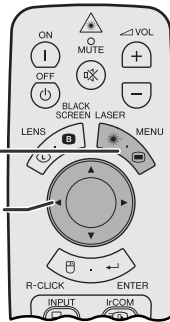

This projector's audio is factory preset to standard settings. However, you can adjust it to suit your own preferences by adjusting the following audio settings.

Description of Adjustment Items

| Selected item | ◀ button | ▶ button |
|----------------|---|--|
| Balance | Increased audio from the left speaker | Increased audio from the right speaker |
| Treble | For weaker treble | For stronger treble |
| Bass | For weaker bass | For stronger bass |
| Reset | All audio adjustment items are returned to the factory preset settings. | |

(GUI) On-screen Display

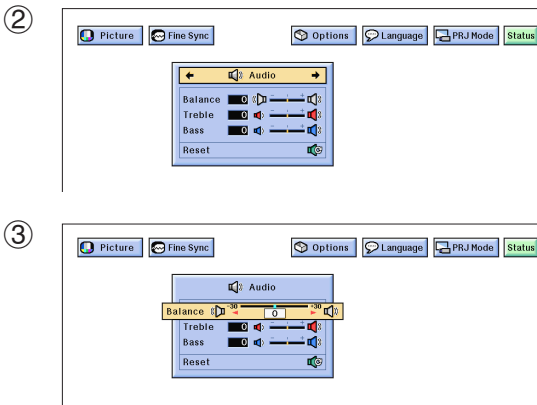

(Slide the **MOUSE/ADJUSTMENT** switch on the remote control to the ADJ. position.)

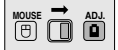

- Press **MENU**. Menu bar and "Picture" menu screen appear. GUI operation guide is also displayed.
- Press ◀/▶ to select "Audio".
- Press ▲/▼ to select a specific adjustment item.
- Press ◀/▶ to move the ● mark of the selected adjustment item to the desired setting.
- To exit from the GUI, press **MENU**.

NOTE

- To reset all adjustment items, select "Reset" on the "Audio" menu screen and press **ENTER**.





Computer Image Adjustments

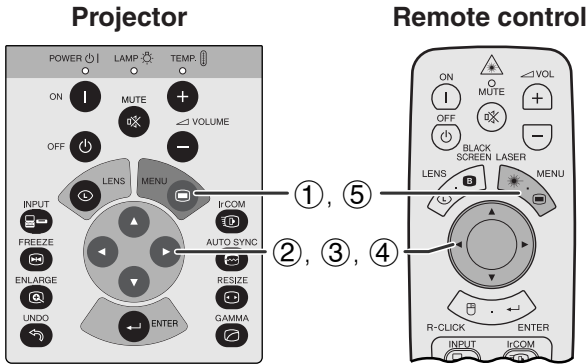

When displaying computer patterns which are very detailed (tiling, vertical stripes, etc.), interference may occur between the LCD pixels, causing flickering, vertical stripes, or contrast irregularities in portions of the screen. Should this occur, adjust “Clock”, “Phase”, “H-Pos” and “V-Pos” for optimum computer image.

Description of Adjustment Items

| Selected item | Description |
|---------------|--|
| Clock | Adjusts vertical noise. |
| Phase | Adjusts horizontal noise (similar to tracking on your VCR). |
| H-Pos | Centres the on-screen image by moving it to the left or right. |
| V-Pos | Centres the on-screen image by moving it up or down. |

NOTE

- Computer image adjustment can be made easily by pressing **AUTO SYNC** (). See the next page for details.

(GUI) On-screen Display

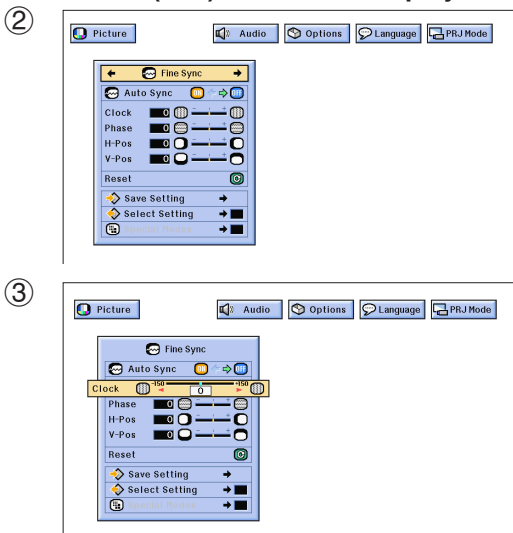

(Select the desired computer input mode with **INPUT**.)

(Slide the **MOUSE/ADJUSTMENT** switch on the remote control to the ADJ. position.)

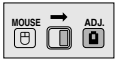

- 1 Press **MENU**. Menu bar and “Picture” menu screen appear. GUI operation guide is also displayed.
- 2 Press **◀/▶** to select “Fine Sync”.
- 3 Press **▲/▼** to select a specific adjustment item.
- 4 Press **◀/▶** to move the **●** mark of the selected adjustment item to the desired setting.
- 5 To exit from the GUI, press **MENU**.

NOTE

- To reset all adjustment items, select “Reset” on the “Fine Sync” menu screen and press **ENTER**.

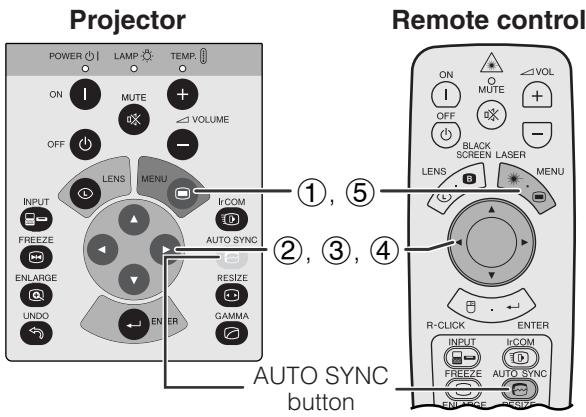

(GUI) On-screen Display

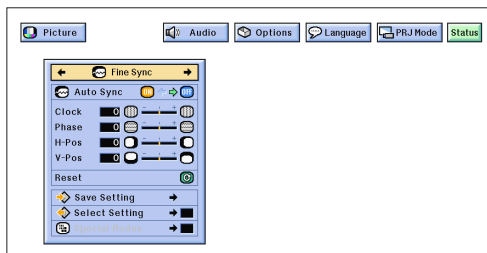

On-screen Display



(GUI) On-screen Display

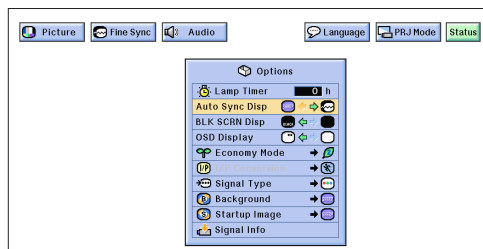

Auto Sync Adjustment

- Used to automatically adjust a computer image.
- Auto Sync adjustment can be made manually by pressing **AUTO SYNC**, or automatically by setting "Auto Sync" to "ON" in the projector's GUI menu.

When "Auto Sync" is set to "ON":

- The **sync** adjustment is automatically made each time the projector is turned on while connected to a computer or the input selection is changed.
- The Auto Sync adjustment setting previously made is cleared when the projector's setting is changed.

(Slide the **MOUSE/ADJUSTMENT** switch on the remote control to the ADJ. position.)

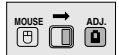

- ① Press **MENU**.
- ② Press ◀/▶ to select "Fine Sync".
- ③ Press ▲/▼ to select "Auto Sync".
- ④ Press ◀/▶ to select "ON".
- ⑤ To exit from the GUI, press **MENU**.

NOTE

- Automatic adjustments can be made by pressing **AUTO SYNC**.
- When the optimum image cannot be achieved with Auto Sync adjustment, use manual adjustments. (See the previous page.)

During Auto Sync adjustment, the On-screen Display changes as shown on the left.

NOTE

- Auto Sync adjustment may take some time to complete, depending on the image of the computer connected to the projector.

Auto Sync Display Function

Normally, an image is not superimposed during Auto Sync adjustment. You can, however, choose to superimpose a background image during Auto Sync adjustment.

(Slide the **MOUSE/ADJUSTMENT** switch on the remote control to the ADJ. position.)

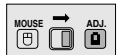

- ① Press **MENU**.
- ② Press ◀/▶ to select "Options".
- ③ Press ▲/▼ to select "Auto Sync Disp".
- ④ Press ◀/▶ to select "□" to superimpose a background image or "☺" to remove the background image during Auto Sync adjustment.
- ⑤ To exit from the GUI, press **MENU**.





Projector

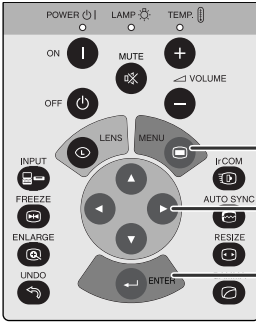

Remote control

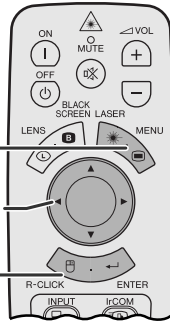

(GUI) On-screen Display

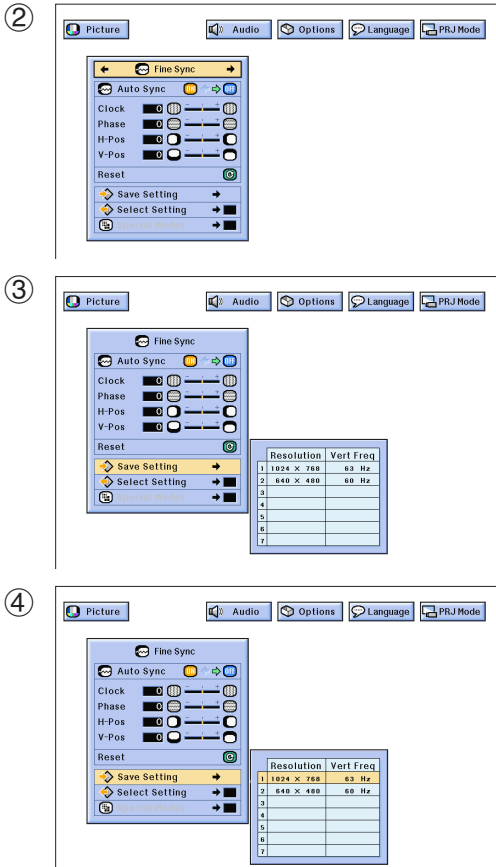

Saving and Selecting Adjustment Settings

This projector allows you to store up to seven adjustment settings for use with various computers. Once these settings are stored, they can be easily selected each time you connect the computer to the projector.

Saving the adjustment setting

(Slide the **MOUSE/ADJUSTMENT** switch on the remote control to the ADJ. position.)

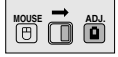

- 1 Press **MENU**.
- 2 Press ◀/▶ to select "Fine Sync".
- 3 Press ▲/▼ to select "Save Setting", and then press ▶.
- 4 Press ▲/▼ to select the desired memory location of the setting.
- 5 Press **ENTER** to save the setting.
- 6 To exit from the GUI, press **MENU**.

Selecting a saved setting

(Slide the **MOUSE/ADJUSTMENT** switch on the remote control to the ADJ. position.)



- 1 Press **MENU**.
- 2 Press ◀/▶ to select "Fine Sync".
- 3 Press ▲/▼ to select "Select Setting", and then press ▶.
- 4 Press ▲/▼ to select the desired memory setting.
- 5 Press **ENTER** to select the setting.
- 6 To exit from the GUI, press **MENU**.

NOTE

- If the memory position has not been set, the resolution and frequency will not be displayed.
- When selecting the stored adjustment setting with "Select Setting", the computer system should match the stored setting.

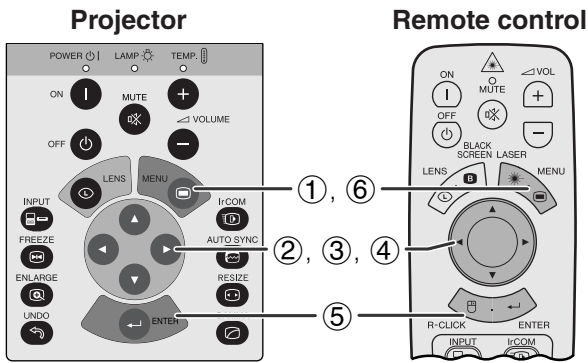

(GUI) On-screen Display

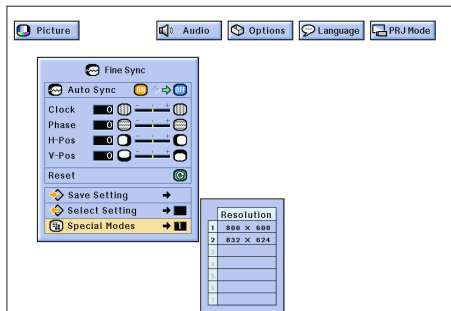

Special Mode Adjustment

Ordinarily, the type of input signal is detected and the correct resolution mode is automatically selected. However, for some signals, "Special Modes" on the "Fine Sync" menu screen may need to be changed to match the computer display mode.

(Slide the **MOUSE/ADJUSTMENT** switch on the remote control to the ADJ. position.)



- ① Press **MENU**.
- ② Press ◀▶ to select "Fine Sync".
- ③ Press ▲/▼ to select "Special Modes".
- ④ Press ▲/▼ to select the optimal resolution mode.
- ⑤ Press **ENTER** to save the setting.
- ⑥ To exit from the GUI, press **MENU**.

NOTE

- Avoid displaying computer patterns which repeat every other line (horizontal stripes). (Flickering may occur, making the image hard to see.)
- When inputting DTV 480P signals, select "480P" in step ④ above.

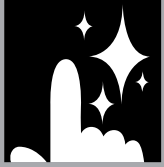

Useful Features

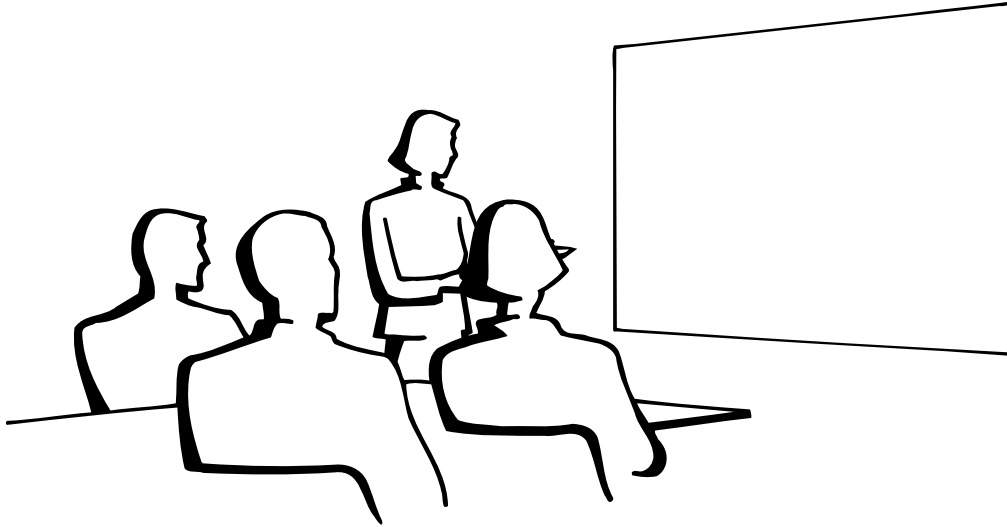

Freeze Function

Projector

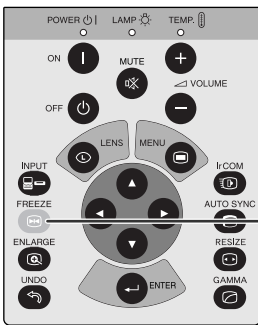

Remote control

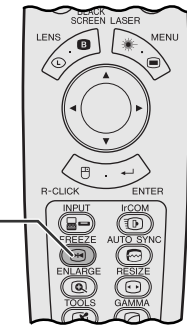

This function allows you to instantly freeze a moving image. This is useful when you want to display a still image from a computer or video, giving you more time to explain the image to the audience.

You can also use this function to display a still image from a computer while you make preparations for the next computer images to be presented.

- ① Press **FREEZE** to freeze the image.
- ② Press **FREEZE** again to return to the moving image.

On-screen Display





Digital Image Magnification

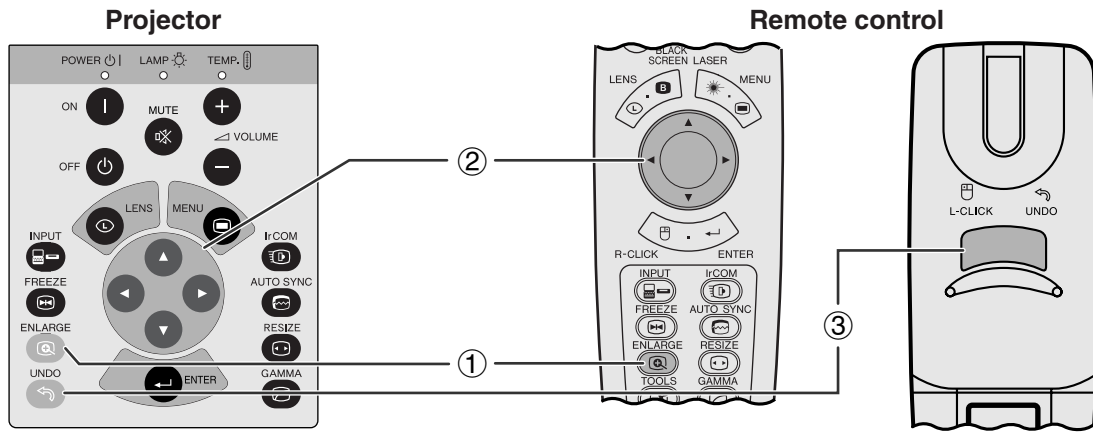

On-screen Display

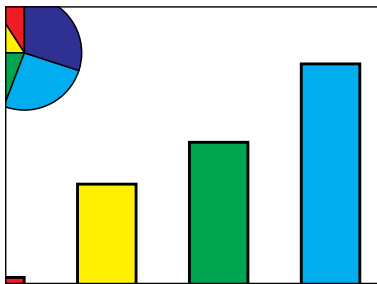
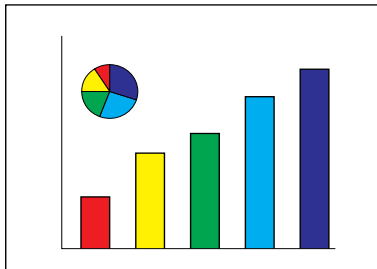

This function allows you to magnify a specific portion of an image. This is useful when you want to display a detailed portion of the image.

(Slide the **MOUSE/ADJUSTMENT** switch on the remote control to the ADJ.)

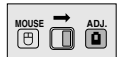

- ① Press **ENLARGE**. Each time **ENLARGE** is pressed, the image will be magnified.
- ② When the image is magnified, you can pan and scan around the image by using **▲/▼/◀/▶**.

NOTE

- Each time **ENLARGE** is pressed, image magnification toggles as shown below.



- If the input signal is changed during digital image magnification, the image will return to $\times 1$. The input signal is changed
 - (a) when **INPUT** is pressed,
 - (b) when the input signal is interrupted, or
 - (c) when the input resolution and refresh rate changes.
- ③ To return to $\times 1$, press **UNDO**.





Gamma Correction

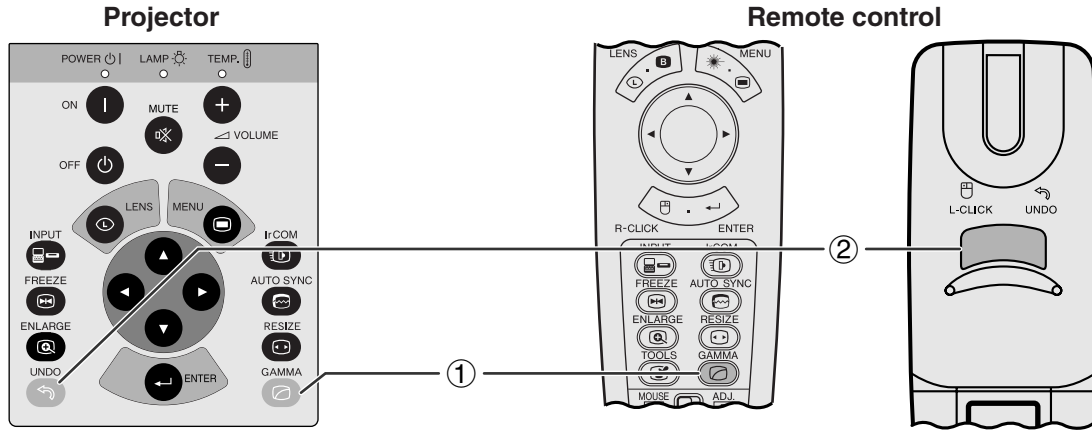

STANDARD

On-screen Display

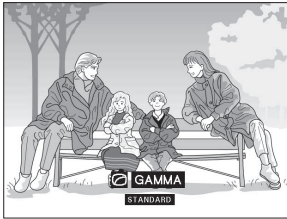

GAMMA 1

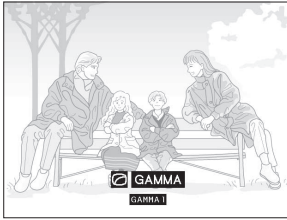

GAMMA 2

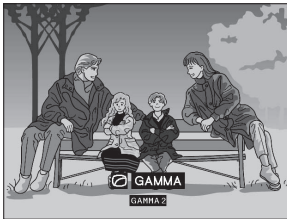

CUSTOM

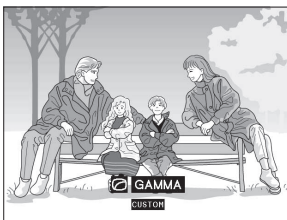

- Gamma is an image quality enhancement function that offers a richer image by brightening the darker portions of the image without altering the brightness of the brighter portions.
- Four gamma settings are available to allow for differences in the images played and in the brightness of the room.
- When you are watching images with frequent, dark scenes, such as a film or concert, or when you are watching images in a bright room, this feature makes the dark scenes easier to see and gives the impression of greater depth in the image.

Gamma Modes

| Selected Mode | Gamma mode |
|-----------------|--|
| STANDARD | Standard picture without gamma correction. |
| GAMMA 1 | Brightens darker portions of image. |
| GAMMA 2 | Gives greater depth to darker portions of image. |
| CUSTOM | Allows you to adjust gamma value using Sharp Advanced Presentation Software. |

(Slide the **MOUSE/ADJUSTMENT** switch on the remote control to the ADJ. position.)

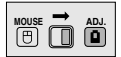

- ① Press **GAMMA**. Each time **GAMMA** is pressed, the gamma level toggles as shown on the left.
- ② To return to the standard image, press **UNDO** while "GAMMA" is displayed on the screen.





Selecting the Picture Display Mode

This function allows you to modify or customise the picture display mode to enhance the input image. Depending on the input signal, you can choose NORMAL, WIDE, DOT BY DOT, DOT BY DOT (WIDE), or FIT TO SCREEN image.

NOTE

- Each time **RESIZE** is pressed, the picture mode changes as shown below.

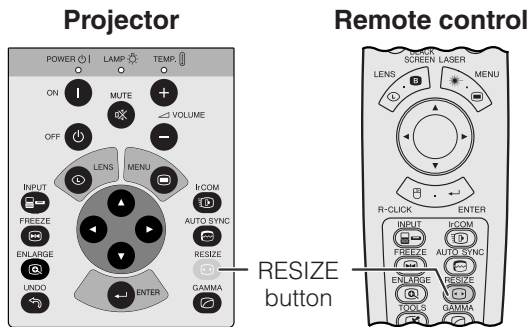

EXAMPLE

| | DTV | | COMPUTER | VIDEO |
|-------------------|------------|------------|-------------|------------|
| MODE | 4:3 | 16:9 | SXGA | PAL |
| INPUT SIGNAL | 480 P | 720 P | | |
| NORMAL | 1024 × 768 | 1024 × 576 | 960 × 768 | 1024 × 768 |
| WIDE | 1024 × 576 | — | 1024 × 768 | 1024 × 576 |
| DOT BY DOT | 640 × 480 | 1280 × 720 | 1280 × 1024 | 720 × 540 |
| DOT BY DOT (WIDE) | 853 × 480 | — | — | — |

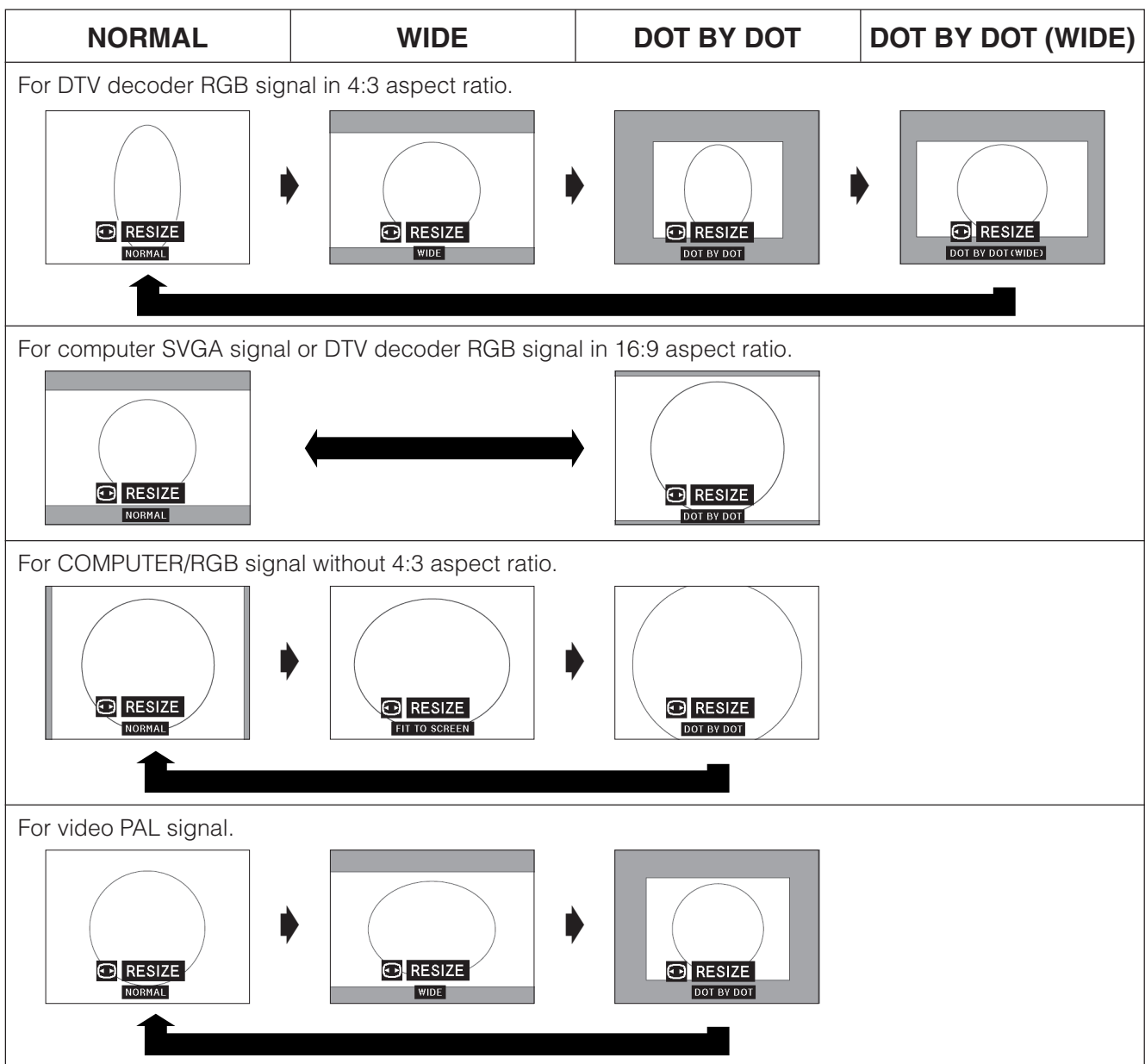

NOTE

- “FIT TO SCREEN” is displayed only when SXGA signals that are not in 4:3 aspect ratio are input.
- DOT BY DOT mode displays images in their native resolution and not expanded to fit the LCD resolution.
- To return to NORMAL mode, press **UNDO** while “RESIZE” is displayed on the screen.



Black Screen Function

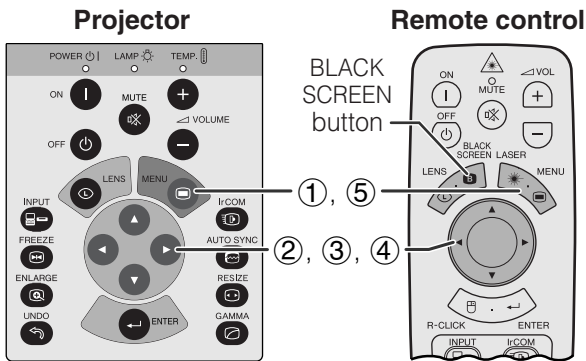

This function can be used to superimpose a black screen over the projected image.

Blacking out the Projected Image

Press **BLACK SCREEN**. "BLACK SCREEN" is displayed on the screen. To return to the original projected image, press **BLACK SCREEN** again.

NOTE

- To use the remote control to operate this function, slide the **MOUSE/ADJUSTMENT** switch to the **MOUSE** position before pressing **BLACK SCREEN**.

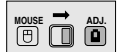
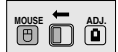

Projected Image

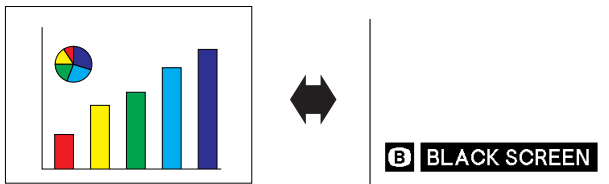

(GUI) On-screen Display

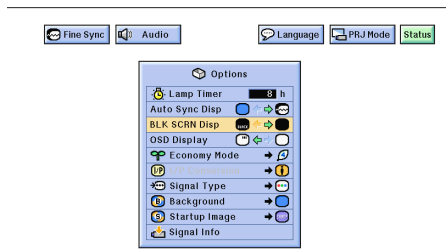

Turning off the On-screen Display

The On-screen Display ("BLACK SCREEN") that appears during black screen can be turned off. When "BLK SCR N Disp" is set to "OFF" in the GUI menu, "BLACK SCREEN" will not be displayed during function.

(Slide the **MOUSE/ADJUSTMENT** switch on the remote control to the ADJ. position.)

- Press **MENU**.
- Press **◀/▶** to select "Options".
- Press **▲/▼** to select "BLK SCR N Disp".
- Press **◀/▶** to select "OFF" to turn on or "ON" to turn off the function.
- To exit from the GUI, press **MENU**.

On-screen Display Override Function

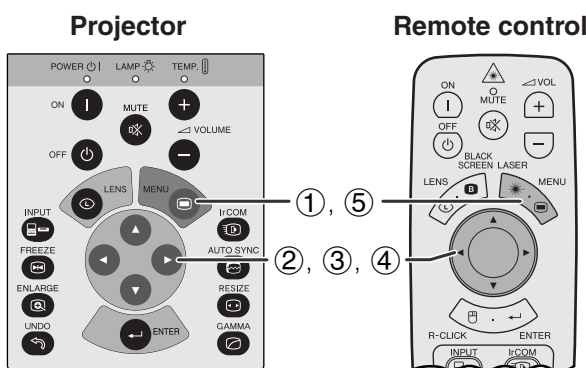

This function allows you to turn off the on-screen messages that appear during "input select" and the "IrCOM" function. Once "OSD Display" is set to "OFF" in the GUI menu, the on-screen messages will not appear when **INPUT** and **IrCOM** are pressed.

(Slide the **MOUSE/ADJUSTMENT** switch on the remote control to the ADJ. position.)

- Press **MENU**.
- Press **◀/▶** to select "Options".
- Press **▲/▼** to select "OSD Display".
- Press **◀/▶** to select "OFF" to turn on or "ON" to turn off the On-screen Display.
- To exit from the GUI, press **MENU**.

(GUI) On-screen Display

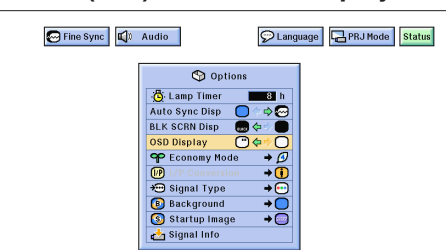



Selecting the Economy Mode

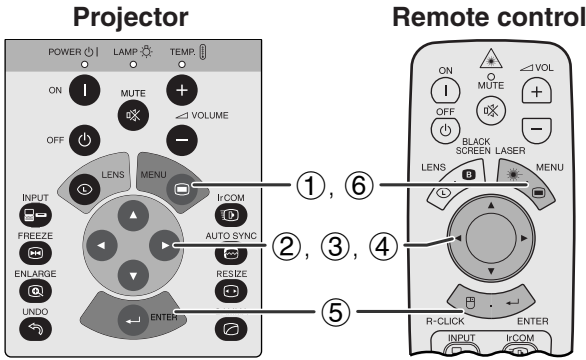

(GUI) On-screen Display

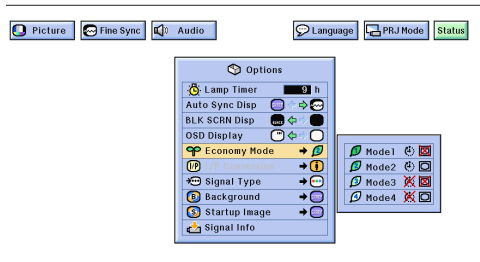

On-screen Display

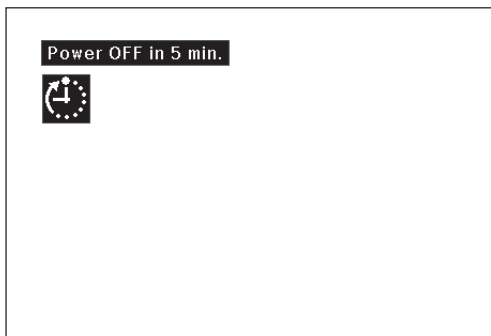

This function allows you to reduce the power consumption when the projector is off.

Economy Modes

| Selected mode | Automatic Power Shutoff | RS232C/Monitor out |
|---------------|-------------------------|--------------------|
| Mode 1 | ON | OFF |
| Mode 2 | ON | ON |
| Mode 3 | OFF | OFF |
| Mode 4 | OFF | ON |

NOTE

- The projector is factory preset to Mode 2.

(Slide the **MOUSE/ADJUSTMENT** switch on the remote control to the ADJ. position.)

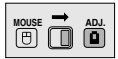

- Press **MENU**.
- Press **◀/▶** to select "Options".
- Press **▲/▼** to select "Economy Mode", and then press **▶**.
- Press **▲/▼** to select the desired mode.
- Press **ENTER** to save the setting.
- To exit from the GUI, press **MENU**.

Automatic Power Shutoff Function

When no input signal is detected for more than 15 minutes, the projector will automatically shut off. The on-screen message on the left will appear five minutes before the power is automatically turned off.

CAUTION

- Select Mode 2 or Mode 4 when using the Sharp Advanced Presentation Software (supplied).





I/P Conversion

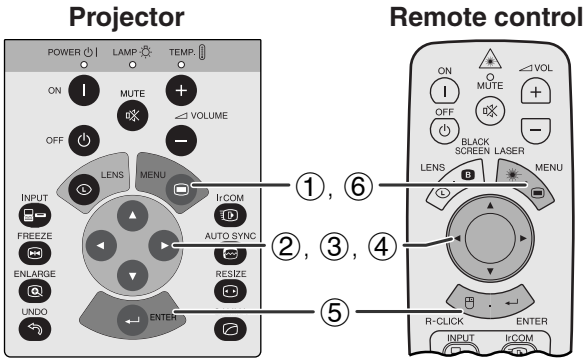

This function allows you to select either an interlaced display or a progressive display of a video signal. The progressive display projects a smooth video image.

(Slide the **MOUSE/ADJUSTMENT** switch on the remote control to the ADJ. position.)

- ① Press **MENU**.
- ② Press **◀/▶** to select "Options".
- ③ Press **▲/▼** to select "I/P Conversion", and then press **▶**.
- ④ Press **▲/▼** to select "Interlaced" or "Progressive".
- ⑤ Press **ENTER** to save the setting.
- ⑥ To exit from the GUI, press **MENU**.

(GUI) On-screen Display

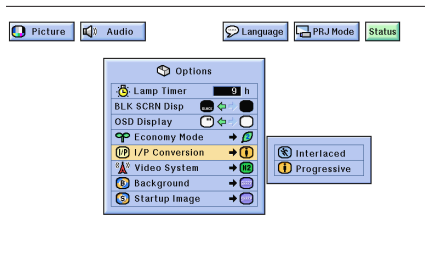

Checking the Lamp Usage Time

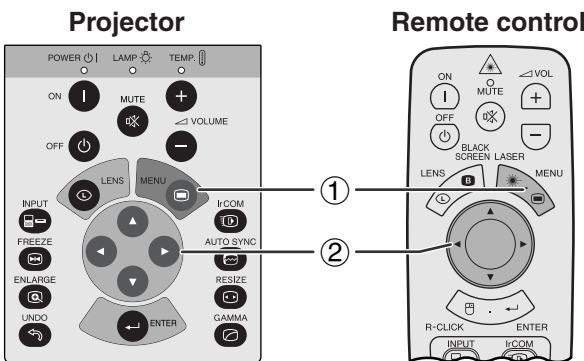

This function allows you to check the accumulated lamp usage time.

(Slide the **MOUSE/ADJUSTMENT** switch on the remote control to the ADJ. position.)

- ① Press **MENU**.
- ② Press **◀/▶** to select "Options". The lamp usage time will be displayed.

NOTE

- It is recommended that the lamp be replaced after approximately 2,000 hours of usage. At this point, take the projector to your nearest Authorised Sharp Industrial LCD Products Dealer or Service Centre to have the lamp replaced. See page 47 for details.



Selecting the Signal Type

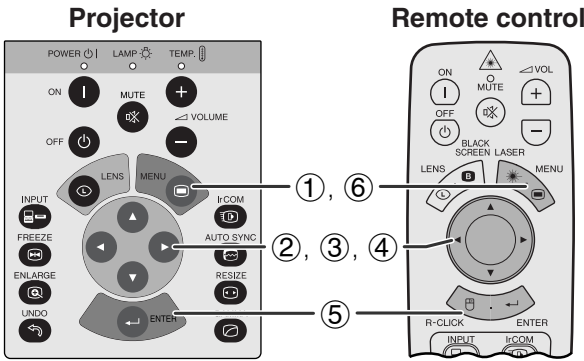

(GUI) On-screen Display

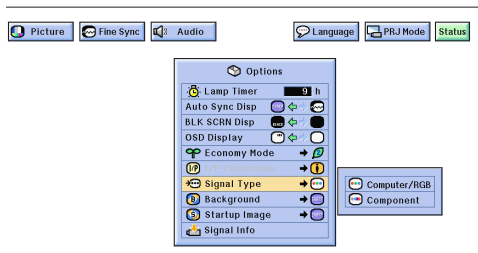

This function allows you to select the input signal type.

(Slide the **MOUSE/ADJUSTMENT** switch on the remote control to the ADJ. position.)



- ① Press **MENU**.
- ② Press ◀/▶ to select "Options".
- ③ Press ▲/▼ to select "Signal Type", and then press ▶.
- ④ Press ▲/▼ to select "Computer/RGB" or "Component".
- ⑤ Press **ENTER** to save the setting.
- ⑥ To exit from the GUI, press **MENU**.



Checking the Input Signal

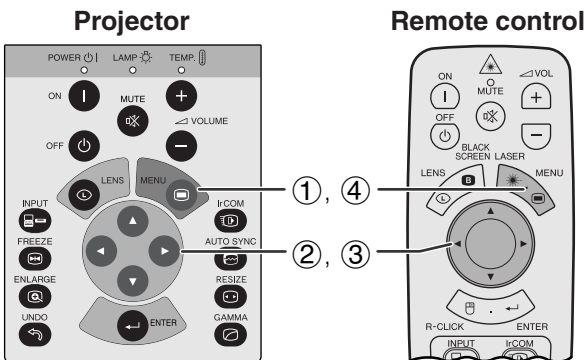

(GUI) On-screen Display

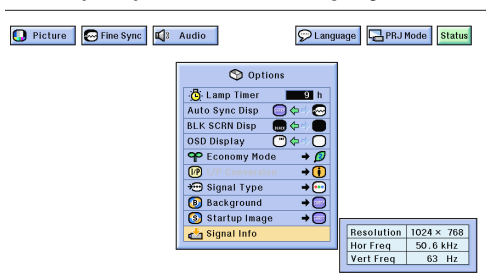

This function allows you to check the current input signal information.

(Slide the **MOUSE/ADJUSTMENT** switch on the remote control to the ADJ. position.)

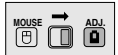

- ① Press **MENU**.
- ② Press ◀/▶ to select "Options".
- ③ Press ▲/▼ to select "Signal Info" to display the current input signal.
- ④ To exit from the GUI, press **MENU**.

NOTE

- In VIDEO mode, the resolution and frequency settings will not be displayed.





Setting a Background Image

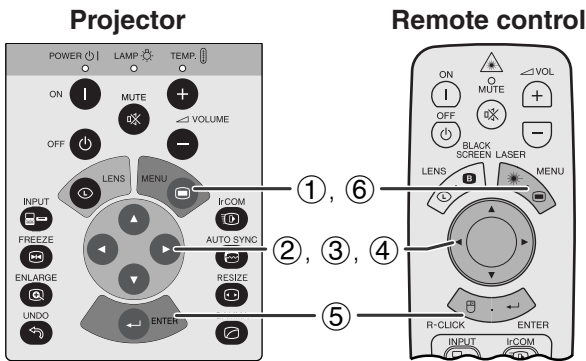

(GUI) On-screen Display

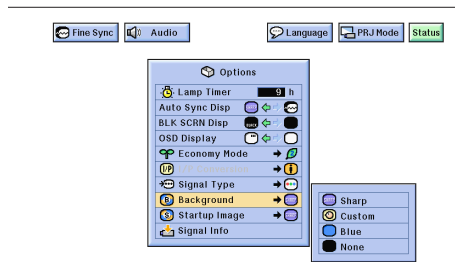

This function allows you to select the image displayed when no signal is being sent to the projector.

Description of Background Images

| Selected item | Background image |
|---------------|---|
| Sharp | SHARP default image |
| Custom | User customised image (i.e. company logo) |
| Blue | Blue screen |
| None | Black screen |

(Slide the **MOUSE/ADJUSTMENT** switch on the remote control to the ADJ. position.)

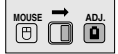

- ① Press **MENU**.
- ② Press **◀/▶** to select "Options".
- ③ Press **▲/▼** to select "Background", and then press **▶**.
- ④ Press **▲/▼** to select the background image you want to display on the screen.
- ⑤ Press **ENTER** to save the setting.
- ⑥ To exit from the GUI, press **MENU**.

NOTE

- By selecting "Custom", the projector can display a custom image (i.e. your company logo) as the background image. Custom image must be 256-colour BMP file with a picture size of 1,024 × 768 or lower. Please see the Sharp Advanced Presentation Software operation manual for how to save (or change) a custom image.



Selecting a Startup Image

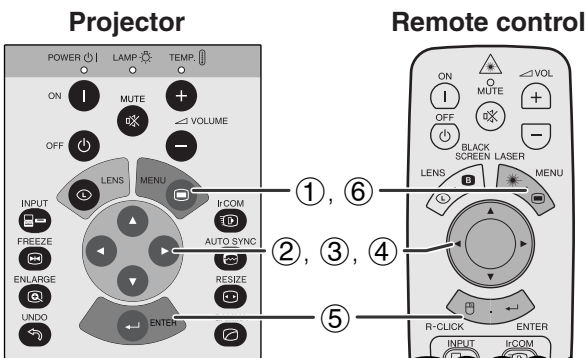

(GUI) On-screen Display

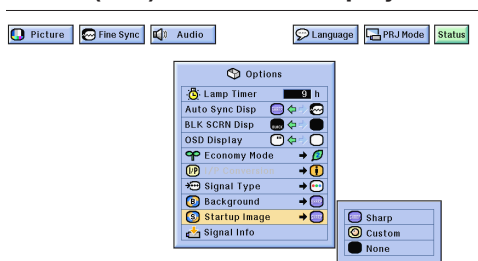

- This function allows you to specify the image to be displayed upon the projector's startup.
- A custom image (i.e. your company logo) can be loaded on the projector via IrCOM or an RS-232C cable. See pages 14 and 25 in this operation manual, and also the supplied Sharp Advanced Presentation Software operation manual for detailed instructions.

Description of Startup Images

| Selected item | Startup image |
|---------------|---|
| Sharp | SHARP default image |
| Custom | User customised image (i.e. company logo) |
| None | Black screen |

(Slide the **MOUSE/ADJUSTMENT** switch on the remote control to the ADJ. position.)

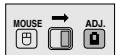

- ① Press **MENU**.
- ② Press **◀/▶** to select "Options".
- ③ Press **▲/▼** to select "Startup Image", and then press **▶**.
- ④ Press **▲/▼** to select the startup image you want to display on the screen.
- ⑤ Press **ENTER** to save the setting.
- ⑥ To exit from the GUI, press **MENU**.

NOTE

- By selecting "Custom", the projector can display a custom image (i.e. your company logo) as the startup image. Custom image must be 256-colour BMP file with a picture size of 1,024 × 768 or lower. Please see the Sharp Advanced Presentation Software operation manual for how to save (or change) a custom image.



Reverse/Invert Image Function

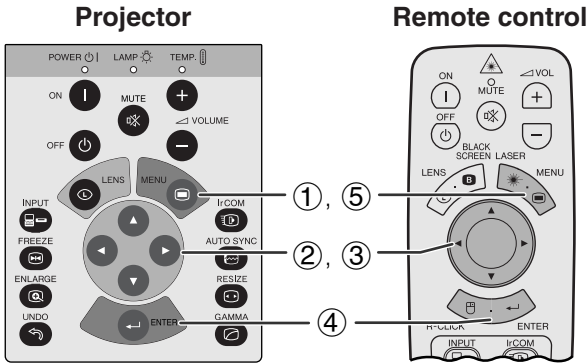

This projector is equipped with a reverse/invert image function which allows you to reverse or invert the projected image for various applications.

Description of Projected Images

| Selected item | Projected image |
|-----------------|-----------------------------|
| Front | Normal image |
| Ceiling + Front | Inverted image |
| Rear | Reversed image |
| Ceiling + Rear | Reversed and inverted image |

(GUI) On-screen Display

When Selecting "Front"

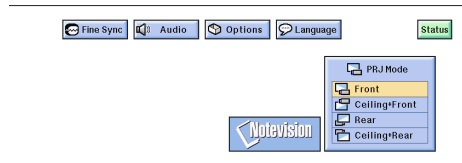

When Selecting "Ceiling + Front"

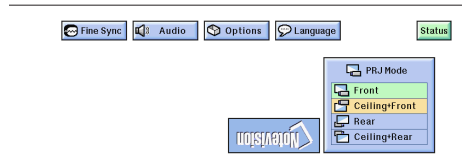

When Selecting "Rear"

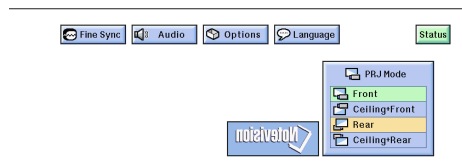

When Selecting "Ceiling + Rear"

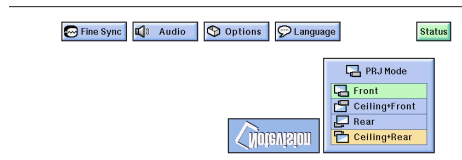

(Slide the **MOUSE/ADJUSTMENT** switch on the remote control to the ADJ. position.)

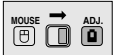

- ① Press **MENU**.
- ② Press ◀/▶ to select "PRJ Mode".
- ③ Press ▲/▼ to select the desired projection mode.
- ④ Press **ENTER** to save the setting.
- ⑤ To exit from the GUI, press **MENU**.

NOTE

- This function is used for the reversed image and ceiling-mount setups. See page 20 for these setups.





Using the Presentation Tools

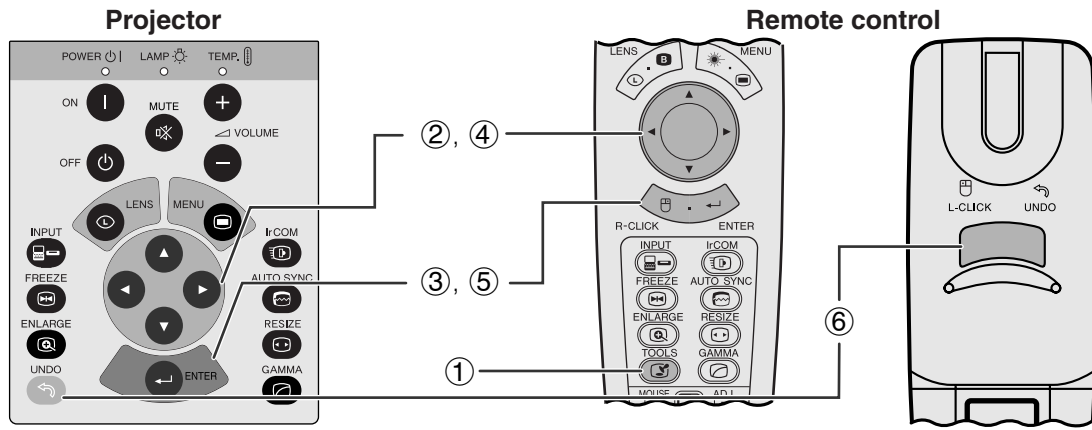

On-screen Display



Menu Window

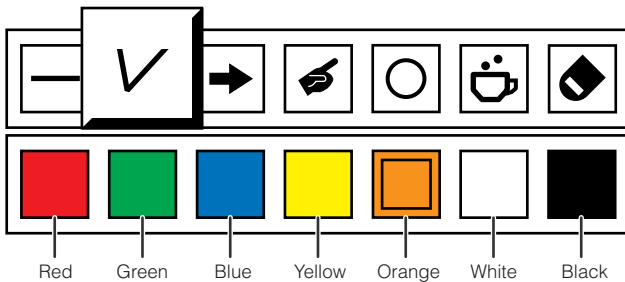

Projector

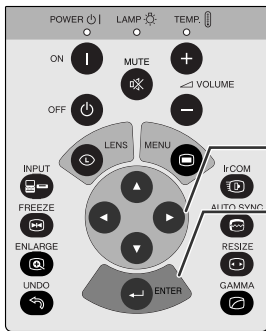

Remote control

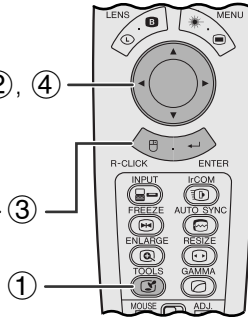

This projector is equipped with presentation tools. These will help you emphasise keypoints within your presentation.

(Slide the **MOUSE/ADJUSTMENT** switch on the remote control to the ADJ. position.)

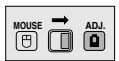

- ① Press **TOOLS** to display the presentation tools menu window on the screen.
- ② Press **▲/▼/◀/▶** to select the desired tool and colour.
- ③ Press **ENTER** to select it.
- ④ Once the tool is displayed on the screen, press **▲/▼/◀/▶** to move it around the screen.
- ⑤ Press **ENTER** to stamp the tool on the screen.
- ⑥ Use **UNDO** to individually delete tools stamped on the screen.

NOTE

- You can stamp each tool as many times as you want on the screen.
- To clear all the stamped presentation tools on the screen, press **▲/▼/◀/▶** to select “” and **ENTER**.

Displaying the break time

(Slide the **MOUSE/ADJUSTMENT** switch on the remote control to the ADJ. position.)

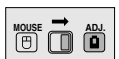

- ① Press **TOOLS** to display the presentation tools menu window on the screen.
- ② Press **▲/▼/◀/▶** to select “” in the menu window.
- ③ Press **ENTER** to start counting down the break time.
- ④ Press **▲** to increase or **▼** to decrease the break time.

NOTE

- The break time is displayed against the background image selected in “Selecting a Startup Image”. (See page 41.)

When selecting Sharp default image





Status Function

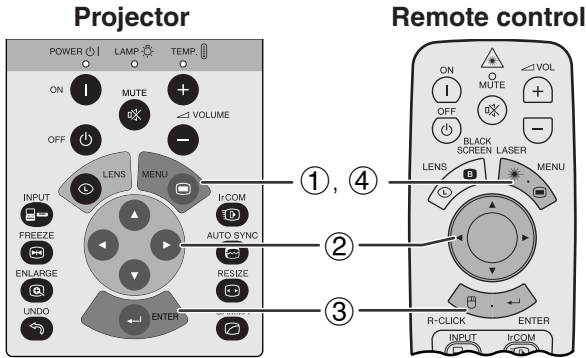

This function can be used to display all the adjusted settings on the screen simultaneously.

(Slide the **MOUSE/ADJUSTMENT** switch on the remote control to the ADJ. position.)



- ① Press **MENU**.
- ② Press **◀▶** to select "Status".
- ③ Press **ENTER** to display all the adjusted settings.
- ④ To exit from the GUI, press **MENU**.

(GUI) On-screen Display

②

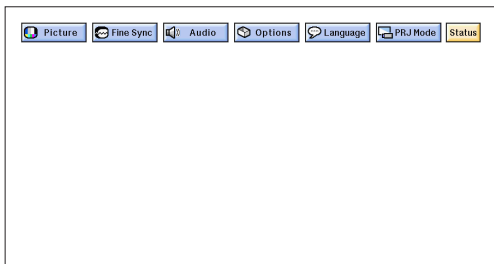

③

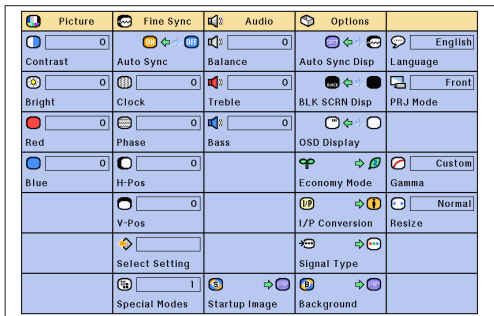



Maintenance & Troubleshooting

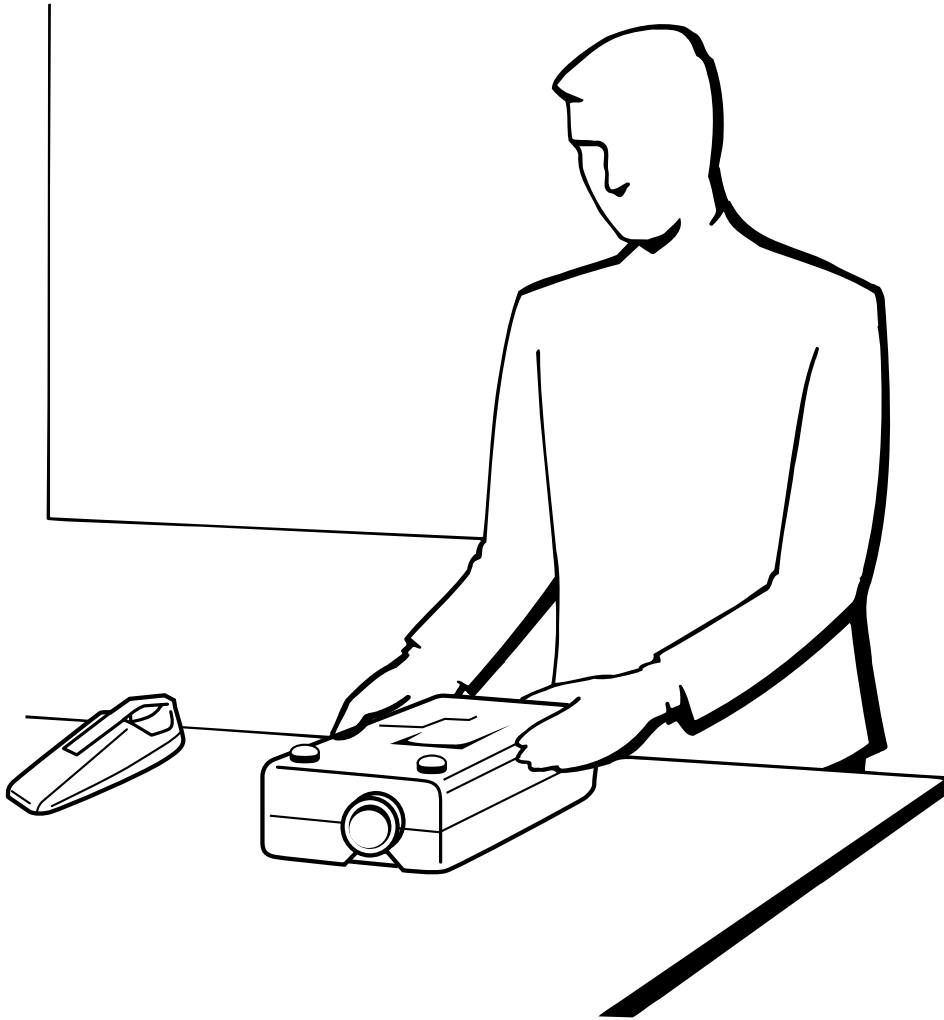



Air Filter Maintenance

- This projector is equipped with two air filters to ensure the optimal operating condition of the projector.
- The air filters should be cleaned every 100 hours of use. Clean the filters more often when the projector is used in a dusty or smoky location.
- Have your nearest Authorised Sharp Industrial LCD Products Dealer or Service Centre exchange the filter (PFILD0080CEZZ) when it is no longer possible to clean it.

Bottom View

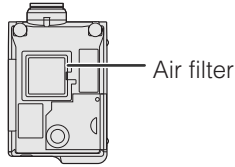

Side and Rear View

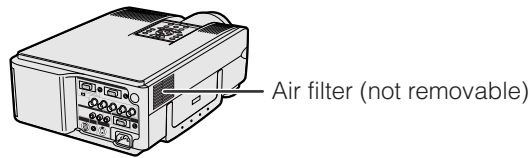

Cleaning and replacing the bottom air filter

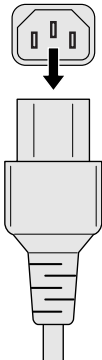
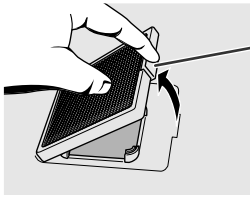
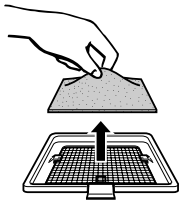
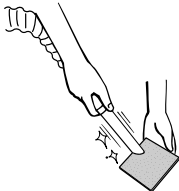
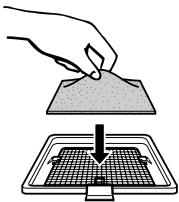
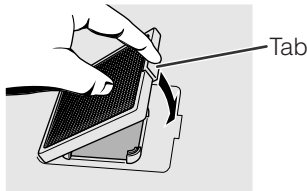
| | | |
|--|---|---|
| <p>1 Unplug the power cord.</p>  | <p>2 Remove the bottom filter cover.</p> <p>Turn over the projector. Press the tab and lift open the filter cover in the direction of the arrow.</p>  <p>Tab</p> | <p>3 Remove the air filter.</p> <p>Grasp the air filter between your fingers and lift it out of the filter cover.</p>  |
| <p>4 Clean the air filter.</p> <p>Clean the dust off the air filter and cover with a vacuum cleaner extension hose.</p>  | <p>5 Replace the air filter.</p> <p>Place the air filter underneath the tabs on the filter frame.</p>  | <p>6 Replace the filter cover.</p> <p>Insert the tab on the end of the filter cover into the filter cover opening and press the filter cover into position.</p>  <p>Tab</p> |

NOTE

- Be sure the filter cover is securely installed. The power will not turn on unless it is correctly installed.

Cleaning the side air filter (not removable)

If dust or dirt has collected inside the air filter, clean the filter with a vacuum cleaner extension hose.

NOTE

- The side air filter cannot be removed.





Lamp/Maintenance Indicators

Maintenance Indicators

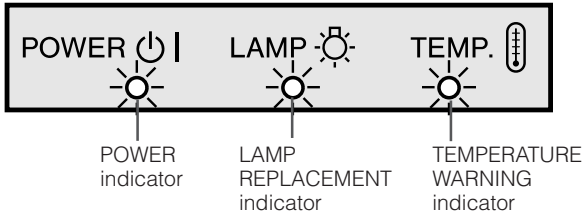

- The warning lights on the projector indicate problems inside the projector.
- There are two warning lights: a TEMPERATURE WARNING indicator which warns that the projector is too hot, and a LAMP REPLACEMENT indicator which lets you know when to change the lamp.
- If a problem occurs, either the TEMPERATURE WARNING indicator or the LAMP REPLACEMENT indicator will light up red. After turning off the power, follow the procedures given below.

| Maintenance Indicator | Condition | Problem | Possible Solution |
|-------------------------------|--|---|--|
| TEMPERATURE WARNING indicator | The internal temperature is abnormally high. | • Blocked air intake. | • Relocate the projector to an area with proper ventilation. |
| | | • Clogged air filter. | • Clean the filter. (See page 46.) |
| | | • Cooling fan breakdown. • Internal circuit failure. | • Take the projector to your nearest Authorised Sharp Industrial LCD Products Dealer or Service Centre for repair. |
| LAMP REPLACEMENT indicator | The lamp does not light up. | • Burnt-out lamp. • Lamp circuit failure. | • Take the projector to your nearest Authorised Sharp Industrial LCD Products Dealer or Service Centre for repair. |
| POWER indicator | The POWER indicator flashes in red when the projector is on. | • The bottom filter cover is open. | • Securely install the bottom filter cover. |

NOTE

- If the TEMPERATURE WARNING indicator lights up, follow the above possible solutions and then wait until the projector has cooled down completely before turning the power back on. (At least 5 minutes.)
- If the power is turned off and then turned on again, as during a brief rest, the LAMP REPLACEMENT indicator may be triggered, preventing the power from going on. Should this occur, take the power cord out of the wall outlet and put it back in again.

Lamp

The lamp in this projector operates for approximately 2,000 cumulative hours, depending on the usage environment. It is recommended that the lamp be replaced after 1,900 cumulative hours of use or when you notice a significant deterioration of the picture and colour quality. At this point, take the projector to your nearest Authorised Sharp Industrial LCD Products Dealer or Service Centre to have the lamp replaced. The lamp usage time can be checked with the On-screen Display (see page 39).

CAUTION

- Intense light hazard. Do not attempt to look into the aperture and lens while the projector is operating.

NOTE

- As the usage environment can vary significantly, the projector lamp may not operate for 2,000 hours.





Using the Kensington Lock

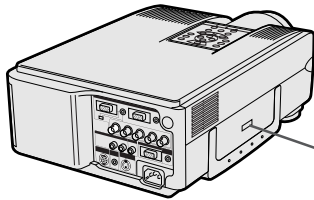

Kensington Security Standard connector

This projector has a Kensington Security Standard connector for use with a Kensington MicroSaver Security System. Refer to the information that came with the system for instructions on how to use it to secure the projector.



Troubleshooting

| Problem | Check |
|--|--|
| No picture and no sound. | <ul style="list-style-type: none"> • Projector power cord is not plugged into the wall outlet. • The bottom filter cover is not securely installed. • Selected input is wrong. (See page 17.) • Cables improperly connected to rear panel of the projector. (See pages 11–15.) • Remote control batteries have run down. (See page 8.) • Remote control's MOUSE/ADJUSTMENT switch is set to MOUSE. |
| Sound is heard but no picture appears. | <ul style="list-style-type: none"> • Cables improperly connected to rear panel of the projector. (See pages 11–15.) • "Contrast" and "Bright" adjustments are set to minimum position. (See page 27.) • On-screen Display ("BLACK SCREEN") is turned off and Black Screen function is turned on, creating a black image. (See page 37.) |
| Colour is faded or poor. | <ul style="list-style-type: none"> • "Color" and "Tint" adjustments are not correct. (See page 27.) |
| Picture is blurred. | <ul style="list-style-type: none"> • Adjust the focus. (See page 19.) • Projection distance is too long or too short to allow for proper focus. (See page 18.) |
| Picture appears but no sound is heard. | <ul style="list-style-type: none"> • Cables improperly connected to rear panel of the projector. (See pages 11–15.) • Volume is set to minimum. (See page 17.) |
| An unusual sound is occasionally heard from the cabinet. | <ul style="list-style-type: none"> • If the picture is normal, the sound is due to cabinet shrinkage caused by temperature changes. This will not affect operation or performance. |
| Maintenance indicator lights up. | <ul style="list-style-type: none"> • Refer to "Lamp/Maintenance Indicators" on page 47. |
| Data cannot be received via IrCOM. | <ul style="list-style-type: none"> • Distance and angle between the projector and transmitting device are out of the designated range. (See page 25.) • Refer to the operation manual of the transmitting device. • Refer to the section "Troubleshooting" in the operation manual of the supplied software. |
| Picture noise appears. | <ul style="list-style-type: none"> • Adjust the phase setting. (See page 29.) • Noise may appear when used with certain computers. Set the NOISE FILTER to ON using the RS-232C command. (See pages 51 and 52.) |
| 480P images do not appear. | <ul style="list-style-type: none"> • Set the resolution mode to 480P. (See page 32.) |
| Colour is distorted (except for VIDEO mode). | <ul style="list-style-type: none"> • Change the input signal type. (See page 40.) |
| Lens comes off. | <ul style="list-style-type: none"> • Align the mark on the lens with the corresponding mark on the projector, push the lens firmly in place, and rotate to the right. |





Appendix

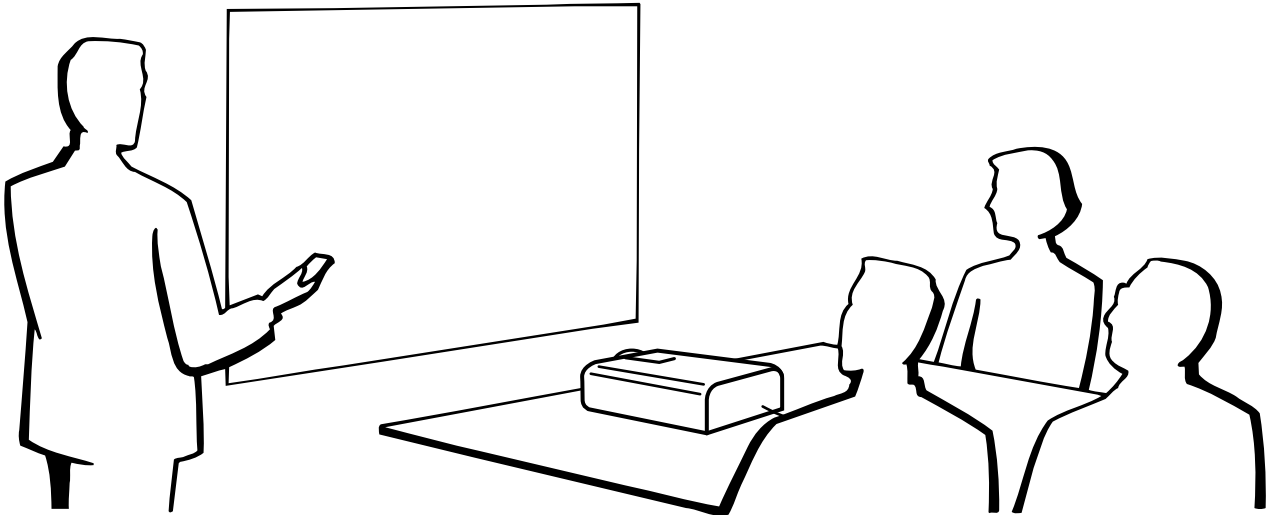

Optional Lenses

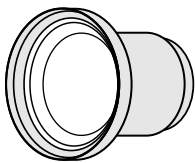

Wide-zoom lens
AN-W6EZ

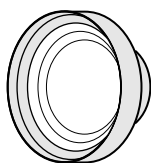

Tele-zoom lens
AN-T6EZ

Optional wide and telephoto lenses from Sharp are also available for specialised application. Please see your local Authorised Sharp Industrial LCD Products Dealer for details on the AN-W6EZ and AN-T6EZ. (Refer to the lens operation manual when attaching the lens.)

254 cm (100") Screen Project Distance

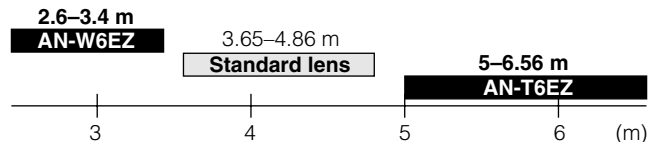

Transporting the Projector

Using the Carrying Handle

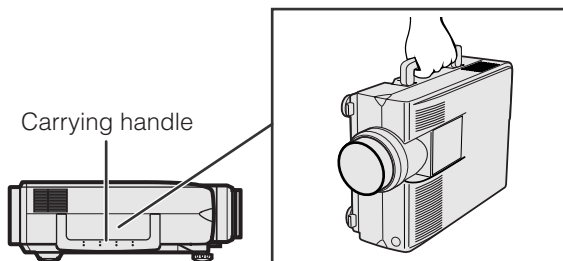

When transporting the projector, carry it by the carrying handle on the side.

CAUTION

- Always put on the lens cap to prevent damage to the lens when transporting the projector.
- Do not lift or carry the projector by the lens or the lens cap as this may damage the lens.





Connection Pin Assignments

Analog Computer 1 and 2 Signal Input Ports: 15-pin mini D-sub female connector

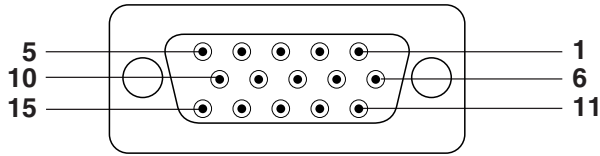

Computer Input

Analog

- | | |
|--------------------------------------|----------------------------|
| 1. Video input (red) | 9. Not connected |
| 2. Video input (green/sync on green) | 10. GND |
| 3. Video input (blue) | 11. GND |
| 4. Reserve input 1 | 12. Bi-directional data |
| 5. Composite sync | 13. Horizontal sync signal |
| 6. Earth (red) | 14. Vertical sync signal |
| 7. Earth (green/sync on green) | 15. Data clock |
| 8. Earth (blue) | |

RS-232C Port: 9-pin D-sub male connector of the DIN-D-sub RS-232C cable

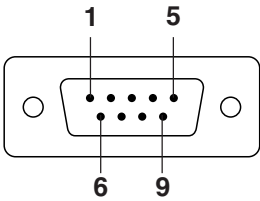

| Pin No. | Signal | Name | I/O | Reference |
|---------|--------|-----------------|--------|-------------------------------|
| 1 | CD | | | Not connected |
| 2 | RD | Receive Data | Input | Connected to internal circuit |
| 3 | SD | Send Data | Output | Connected to internal circuit |
| 4 | ER | | | Not connected |
| 5 | SG | Signal Ground | | Connected to internal circuit |
| 6 | DR | Data Set Ready | Output | Not connected |
| 7 | RS | Request to Send | Output | Connected to internal circuit |
| 8 | CS | Clear to Send | Input | Connected to internal circuit |
| 9 | CI | | | Not connected |

RS-232C Terminal: 9-pin Mini DIN connector

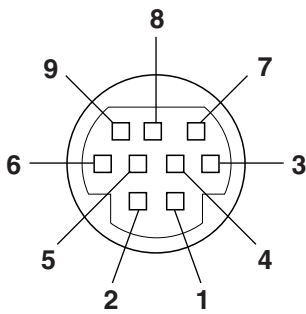

| Pin No. | Signal | Name | I/O | Reference |
|---------|--------|--|--------|-------------------------------|
| 1 | VCC | + 3.3V (Reserved) | Output | Not connected |
| 2 | RD | Receive Data | Input | Connected to internal circuit |
| 3 | SD | Send Data | Output | Connected to internal circuit |
| 4 | EXIR | Detector of Option Unit (Reserved) | Input | Not connected |
| 5 | SG | Signal Ground | | Connected to internal circuit |
| 6 | ERX | IR Receive Signal from IR Amplifire (Reserved) | Input | Not connected |
| 7 | RS | Request to Send | Output | Connected to internal circuit |
| 8 | CS | Clear to Send | Input | Connected to internal circuit |
| 9 | ETX | IR Transmit Signal (Reserved) | Output | Not connected |





RS-232C Port Specifications

PC control

A computer can be used to control the projector by connecting an RS-232C cable (cross type, sold separately) to the projector. (See page 14 for connection.)

Communication conditions

Set the serial port settings of the computer to match that of the table.

Signal format: Conforms to RS-232C standard.

Baud rate: 9,600 bps

Data length: 8 bits

Parity bit: NON

Stop bit: 1 bit

Flow control: None

Basic format

Commands from the computer are sent in the following order: command, parameter, and return code. After the projector processes the command from the computer, it sends a response code to the computer.

Command format

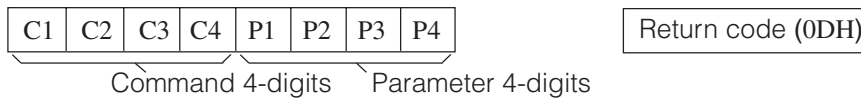

Response code format

Normal response



Problem response (communication error or incorrect command)



When more than one code is being sent, send each command only after the OK response code for the previous command from the projector is verified.

NOTE

- When using the computer control function of the projector, the projector operating status cannot be read to the computer. Therefore, confirm the status by transmitting the display commands for each adjustment menu and checking the status with the On-screen Display. If the projector receives a command other than a menu display command, it will execute the command without displaying the On-screen Display.

Commands

EXAMPLE

- When "BRIGHT" of INPUT 1 IMAGE ADJUSTMENT is set to -10.

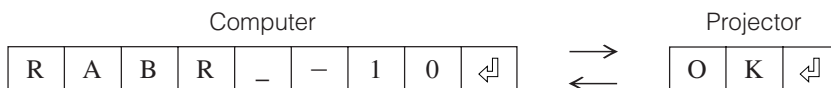

| CONTROL ITEM | COMMAND | | | | PARAMETER | | | | CONTROL CONTENTS |
|-----------------|---------|----|----|----|-----------|----|----|----|------------------------|
| | C1 | C2 | C3 | C4 | P1 | P2 | P3 | P4 | |
| AUTO POWER OFF | A | P | O | W | _ | _ | _ | 0 | AUTO POWER OFF |
| | A | P | O | W | _ | _ | _ | 1 | AUTO POWER ON |
| POWER SETTING | P | O | W | R | _ | _ | _ | 0 | POWER OFF (STANDBY) |
| | P | O | W | R | _ | _ | _ | 1 | POWER ON |
| INPUT SWITCHING | I | V | E | D | _ | _ | _ | 1 | VIDEO |
| | I | R | G | B | _ | _ | _ | 1 | INPUT1 |
| | I | R | G | B | _ | _ | _ | 2 | INPUT2 |
| | I | C | O | M | _ | _ | _ | 1 | IrCOM1 |
| | I | C | O | M | _ | _ | _ | 2 | IrCOM2 |
| INPUT CHECK | I | C | H | K | _ | _ | _ | 0 | INPUT CHECK |
| LENS ADJUSTMENT | L | N | F | O | _ | * | * | * | LENS FOCUS (-30 - +30) |
| | L | N | Z | O | _ | * | * | * | LENS ZOOM (-30 - +30) |
| | K | E | Y | S | * | * | * | * | KEystone (-127 - +127) |

| CONTROL ITEM | COMMAND | | | | PARAMETER | | | | CONTROL CONTENTS |
|--------------------|---------|----|----|----|-----------|----|----|-----|------------------|
| | C1 | C2 | C3 | C4 | P1 | P2 | P3 | P4 | |
| LANGUAGE SELECTION | M | E | L | A | _ | _ | _ | 1 | ENGLISH |
| | M | E | L | A | _ | _ | _ | 2 | DEUTSCH |
| | M | E | L | A | _ | _ | _ | 3 | ESPAÑOL |
| | M | E | L | A | _ | _ | _ | 4 | NEDERLANDS |
| | M | E | L | A | _ | _ | _ | 5 | FRANÇAIS |
| | M | E | L | A | _ | _ | _ | 6 | ITALIANO |
| | M | E | L | A | _ | _ | _ | 7 | SVENSKA |
| | M | E | L | A | _ | _ | _ | 8 | 日本語 |
| | M | E | L | A | _ | _ | _ | 9 | PORTUGUÊS |
| | M | E | L | A | _ | _ | 1 | 0 | 汉语 |
| M | E | L | A | _ | _ | 1 | 1 | 한국어 | |



RS-232C Port Specifications

| CONTROL ITEM | COMMAND | | | | PARAMETER | | | | CONTROL CONTENTS | |
|----------------------------|--------------------------|----|----|----|-----------|----|----|----|-----------------------|----------------------|
| | C1 | C2 | C3 | C4 | P1 | P2 | P3 | P4 | | |
| VIDEO SYSTEM SELECTION | M | E | S | Y | - | - | - | 1 | AUTO | |
| | M | E | S | Y | - | - | - | 2 | PAL (50/60 Hz) | |
| | M | E | S | Y | - | - | - | 3 | SECAM | |
| | M | E | S | Y | - | - | - | 4 | NTSC 4.43 | |
| | M | E | S | Y | - | - | - | 5 | NTSC 3.58 | |
| VIDEO IMAGE ADJUSTMENT | V | A | P | I | - | * | * | * | CONTRAST (-30 - +30) | |
| | V | A | B | R | - | * | * | * | BRIGHT (-30 - +30) | |
| | V | A | C | O | - | * | * | * | COLOR (-30 - +30) | |
| | V | A | T | I | - | * | * | * | TINT (-30 - +30) | |
| | V | A | S | H | - | * | * | * | SHARPNESS (-30 - +30) | |
| | V | A | R | E | - | - | - | 1 | RESET | |
| | V | A | R | D | - | * | * | * | RED (-30 - +30) | |
| | V | A | B | E | - | * | * | * | BLUE (-30 - +30) | |
| | V | A | R | E | - | - | - | 0 | VIDEO DISPLAY | |
| | V | A | R | E | - | - | - | 1 | RESET | |
| | BACKGROUND SELECTION | I | M | B | G | - | - | - | 1 | SHARP |
| | | I | M | B | G | - | - | - | 2 | CUSTOM |
| | | I | M | B | G | - | - | - | 3 | BLUE |
| I | | M | B | G | - | - | - | 4 | NONE | |
| STARTUP IMAGE SELECTION | I | M | S | I | - | - | - | 1 | SHARP | |
| | I | M | S | I | - | - | - | 2 | CUSTOM | |
| | I | M | S | I | - | - | - | 3 | NONE | |
| VOLUME ADJUSTMENT | V | O | L | A | - | - | * | * | VOLUME (00 - 60) | |
| | M | U | T | E | - | - | - | 0 | MUTE OFF | |
| | M | U | T | E | - | - | - | 1 | MUTE ON | |
| AUDIO ADJUSTMENT | A | A | B | L | - | * | * | * | BALANCE (-30 - +30) | |
| | A | A | T | E | - | * | * | * | TREBLE (-30 - +30) | |
| | A | A | B | A | - | * | * | * | BASS (-30 - +30) | |
| | A | A | R | E | - | - | - | 0 | AUDIO DISPLAY | |
| | A | A | R | E | - | - | - | 1 | RESET | |
| INPUT 1 IMAGE ADJUSTMENT | R | A | P | I | - | * | * | * | CONTRAST (-30 - +30) | |
| | R | A | B | R | - | * | * | * | BRIGHT (-30 - +30) | |
| | R | A | R | D | - | * | * | * | RED (-30 - +30) | |
| | R | A | B | E | - | * | * | * | BLUE (-30 - +30) | |
| | R | A | R | E | - | - | - | 0 | INPUT 1 DISPLAY | |
| | R | A | C | O | - | * | * | * | COLOR (-30 - +30) | |
| | R | A | T | I | - | * | * | * | TINT (-30 - +30) | |
| | R | A | S | H | - | * | * | * | SHARPNESS (-30 - +30) | |
| | R | A | R | E | - | - | - | 1 | RESET | |
| | INPUT 2 IMAGE ADJUSTMENT | R | B | P | I | - | * | * | * | CONTRAST (-30 - +30) |
| R | | B | B | R | - | * | * | * | BRIGHT (-30 - +30) | |
| R | | B | R | D | - | * | * | * | RED (-30 - +30) | |
| R | | B | B | E | - | * | * | * | BLUE (-30 - +30) | |
| R | | B | R | E | - | - | - | 0 | INPUT 2 DISPLAY | |
| R | | B | C | O | - | * | * | * | COLOR (-30 - +30) | |
| R | | B | T | I | - | * | * | * | TINT (-30 - +30) | |
| R | | B | S | H | - | * | * | * | SHARPNESS (-30 - +30) | |
| R | | B | R | E | - | - | - | 1 | RESET | |
| INPUT AUTO SYNCHRONIZATION | | A | A | D | J | - | - | - | 0 | AUTO SYNC OFF |
| | A | A | D | J | - | - | - | 1 | AUTO SYNC ON | |
| | A | D | J | S | - | - | - | 1 | AUTO SYNC START | |

| CONTROL ITEM | COMMAND | | | | PARAMETER | | | | CONTROL CONTENTS | |
|------------------------------|----------------|----|----|----|-----------|----|----|----|----------------------------|-----------------|
| | C1 | C2 | C3 | C4 | P1 | P2 | P3 | P4 | | |
| INPUT ADJUSTMENT | I | N | C | L | * | * | * | * | CLOCK (-150 - +150) | |
| | I | N | P | H | - | * | * | * | PHASE (-60 - +60) | |
| | I | A | H | P | * | * | * | * | H-POS (-150 - +150) | |
| | I | A | V | P | - | * | * | * | V-POS (-60 - +60) | |
| | I | A | R | E | - | - | - | 0 | COMPUTER INPUT DISPLAY | |
| | I | A | R | E | - | - | - | 1 | RESET | |
| | SCREEN SETTING | I | M | D | I | - | - | - | 0 | OSD DISPLAY OFF |
| I | | M | D | I | - | - | - | 1 | OSD DISPLAY ON | |
| I | | M | R | E | - | - | - | 0 | REVERSE OFF | |
| I | | M | R | E | - | - | - | 1 | REVERSE ON | |
| I | | M | I | N | - | - | - | 0 | INVERT OFF | |
| I | | M | I | N | - | - | - | 1 | INVERT ON | |
| I | | M | A | S | - | - | - | 0 | AUTO SYNC DISPLAY OFF | |
| I | | M | A | S | - | - | - | 1 | AUTO SYNC DISPLAY ON | |
| I | | M | I | P | - | - | - | 0 | I/P CONVERSION INTERLACED | |
| I | | M | I | P | - | - | - | 1 | I/P CONVERSION PROGRESSIVE | |
| INPUT1 SIGNAL TYPE SELECTION | | I | A | S | I | - | - | - | 1 | RGB |
| | | I | A | S | I | - | - | - | 2 | COMPONENT |
| INPUT2 SIGNAL TYPE SELECTION | | I | B | S | I | - | - | - | 1 | RGB |
| | I | B | S | I | - | - | - | 2 | COMPONENT | |
| INPUT GAMMA SELECTION | G | A | M | R | - | - | - | 1 | STANDARD | |
| | G | A | M | R | - | - | - | 2 | GAMMA1 | |
| | G | A | M | R | - | - | - | 3 | GAMMA2 | |
| | G | A | M | R | - | - | - | 4 | CUSTOM | |
| VIDEO GAMMA SELECTION | G | A | M | V | - | - | - | 1 | STANDARD | |
| | G | A | M | V | - | - | - | 2 | GAMMA1 | |
| | G | A | M | V | - | - | - | 3 | GAMMA2 | |
| | G | A | M | V | - | - | - | 4 | CUSTOM | |
| VIDEO CONFIRMATION | S | Y | S | E | - | - | - | 0 | DISPLAY | |
| BLACK SCREEN | I | M | B | K | - | - | - | 0 | BLACK SCREEN OFF | |
| | I | M | B | K | - | - | - | 1 | BLACK SCREEN ON | |
| | I | M | B | O | - | - | - | 0 | BLACK SCREEN DISPLAY OFF | |
| | I | M | B | O | - | - | - | 1 | BLACK SCREEN DISPLAY ON | |
| SCREEN MODE MEMORY | M | E | M | S | - | - | - | * | SAVE SETTING (1-7) | |
| | M | E | M | L | - | - | - | * | SELECT SETTING (1-7) | |
| INPUT1 RESIZE | R | A | S | R | - | - | - | 1 | NORMAL | |
| | R | A | S | R | - | - | - | 2 | WIDE/FIT TO SCREEN | |
| | R | A | S | R | - | - | - | 3 | DOT BY DOT | |
| | R | A | S | R | - | - | - | 4 | DOT BY DOT (WIDE) | |
| INPUT2 RESIZE | R | B | S | R | - | - | - | 1 | NORMAL | |
| | R | B | S | R | - | - | - | 2 | WIDE/FIT TO SCREEN | |
| | R | B | S | R | - | - | - | 3 | DOT BY DOT | |
| | R | B | S | R | - | - | - | 4 | DOT BY DOT (WIDE) | |
| VIDEO RESIZE | R | A | S | V | - | - | - | 1 | NORMAL | |
| | R | A | S | V | - | - | - | 2 | WIDE | |
| | R | A | S | V | - | - | - | 3 | DOT BY DOT | |
| NOISE FILTER | N | F | I | L | - | - | - | 0 | FILTER OFF | |
| | N | F | I | L | - | - | - | 1 | FILTER ON | |

NOTE

- If a dash (_) appears in the parameter column, enter a space. If an asterisk (*) appears, enter a value in the range indicated in brackets under CONTROL CONTENTS.
- INPUT ADJUSTMENT can only be set in the displayed computer mode.
- Noise may appear when used with certain computers. Set the NOISE FILTER to ON using the RS-232C command.





Wired Remote Control Terminal Specifications

Specifications of wired remote control input

- ø3.5 mm minijack
- External: +5 V (1 A)
- Internal: GND

Function and transmission codes

| No. | Control Item (Function) | System Code | | | | | Data Code | | | | | External Code | | | | |
|-----|----------------------------|-------------|----|----|----|----|-----------|----|----|----|-----|---------------|-----|-----|-----|-----|
| | | C1 | C2 | C3 | C4 | C5 | C6 | C7 | C8 | C9 | C10 | C11 | C12 | C13 | C14 | C15 |
| 1 | POWER ON | 1 | 0 | 1 | 1 | 0 | 0 | 1 | 1 | 0 | 1 | 0 | 1 | 0 | 1 | 0 |
| 2 | POWER OFF | 1 | 0 | 1 | 1 | 0 | 0 | 1 | 1 | 0 | 1 | 0 | 0 | 1 | 1 | 0 |
| 3 | VOLUME - | 1 | 0 | 1 | 1 | 0 | 1 | 0 | 1 | 0 | 1 | 0 | 0 | 0 | 1 | 0 |
| 4 | VOLUME + | 1 | 0 | 1 | 1 | 0 | 0 | 0 | 1 | 0 | 1 | 0 | 0 | 0 | 1 | 0 |
| 5 | MUTE | 1 | 0 | 1 | 1 | 0 | 1 | 1 | 1 | 0 | 1 | 0 | 0 | 0 | 1 | 0 |
| 6 | MENU | 1 | 0 | 1 | 1 | 0 | 0 | 0 | 1 | 0 | 0 | 0 | 1 | 1 | 1 | 0 |
| 7 | LENS | 1 | 0 | 1 | 1 | 0 | 1 | 1 | 0 | 1 | 0 | 0 | 0 | 1 | 1 | 0 |
| 8 | TOOLS | 1 | 0 | 1 | 1 | 0 | 0 | 1 | 0 | 1 | 0 | 1 | 1 | 1 | 1 | 0 |
| 9 | BLACK SCREEN | 1 | 0 | 1 | 1 | 0 | 1 | 0 | 0 | 1 | 0 | 1 | 1 | 1 | 0 | 1 |
| 10 | ENTER | 1 | 0 | 1 | 1 | 0 | 1 | 1 | 1 | 0 | 1 | 0 | 1 | 0 | 1 | 0 |
| 11 | UNDO | 1 | 0 | 1 | 1 | 0 | 1 | 0 | 0 | 1 | 1 | 0 | 1 | 0 | 1 | 0 |

| No. | Control Item (Function) | System Code | | | | | Data Code | | | | | External Code | | | | |
|-----|----------------------------|-------------|----|----|----|----|-----------|----|----|----|-----|---------------|-----|-----|-----|-----|
| | | C1 | C2 | C3 | C4 | C5 | C6 | C7 | C8 | C9 | C10 | C11 | C12 | C13 | C14 | C15 |
| 12 | IrCOM | 1 | 0 | 1 | 1 | 0 | 1 | 1 | 1 | 0 | 1 | 1 | 0 | 1 | 1 | 0 |
| 13 | INPUT | 1 | 0 | 1 | 1 | 0 | 1 | 1 | 0 | 0 | 1 | 0 | 0 | 0 | 1 | 0 |
| 14 | FREEZE | 1 | 0 | 1 | 1 | 0 | 1 | 0 | 1 | 1 | 0 | 0 | 0 | 0 | 1 | 1 |
| 15 | ENLARGE | 1 | 0 | 1 | 1 | 0 | 1 | 0 | 1 | 1 | 0 | 1 | 1 | 0 | 1 | 0 |
| 16 | AUTO SYNC | 1 | 0 | 1 | 1 | 0 | 0 | 1 | 0 | 1 | 1 | 1 | 1 | 1 | 1 | 1 |
| 17 | ADJUST ▲ | 1 | 0 | 1 | 1 | 0 | 0 | 0 | 1 | 1 | 1 | 0 | 0 | 0 | 1 | 1 |
| 18 | ADJUST ▼ | 1 | 0 | 1 | 1 | 0 | 1 | 0 | 1 | 1 | 1 | 0 | 0 | 1 | 1 | 0 |
| 19 | ADJUST ◀ | 1 | 0 | 1 | 1 | 0 | 0 | 0 | 0 | 0 | 1 | 0 | 1 | 0 | 1 | 0 |
| 20 | ADJUST ▶ | 1 | 0 | 1 | 1 | 0 | 1 | 1 | 1 | 1 | 0 | 0 | 1 | 0 | 1 | 0 |
| 21 | RESIZE | 1 | 0 | 1 | 1 | 0 | 0 | 1 | 1 | 1 | 1 | 0 | 1 | 0 | 1 | 0 |
| 22 | GAMMA | 1 | 0 | 1 | 1 | 0 | 0 | 0 | 0 | 0 | 0 | 0 | 1 | 0 | 1 | 0 |

NOTE

- To operate the mouse, left-click and right-click functions through the wired remote control input, connect the cable from the WIRED REMOTE control input terminal on the projector to the remote control. The codes for these functions are complex and are, therefore, not listed here.

Wired remote control function code

LSB

MSB

| C1 | System Code | | | | C5 | C6 | Data Code | | | | | C13 | C14 | C15 | |
|----|-------------|---|---|---|----|----|-----------|---|---|---|---|-----|-----|-----|---|
| 1 | 0 | 1 | 1 | 0 | 0 | * | * | * | * | * | * | * | 1 | 0 | 0 |

- System codes C1 to C5 are fixed at “10110”.
- Codes C14 and C15 are reverse confirmation bits, with “10” indicating “Front” and “01” indicating “Rear”.

Sharp remote control signal format

Transmission format: 15-bit format

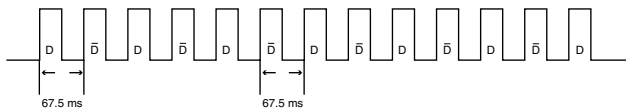

Wave form of output signal: Output using Pulse Position Modulation

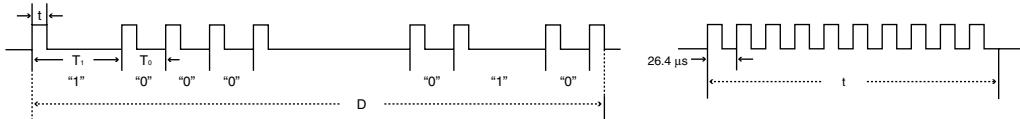

- $t = 264 \mu s$
- $T_0 = 1.05 ms$
- $T_1 = 2.10 ms$
- Pulse carrier frequency = 455/12 kHz
- Duty ratio = 1:1

Transmission control code

15 bit

| C1 | C2 | C3 | C4 | C5 | C6 | C7 | C8 | C9 | C10 | C11 | C12 | C13 | C14 | C15 |
|--------------------------------|----|----|----|----|-----------------------|----|----|----|-----|----------------|-----|------|--------------------|-----|
| System Address | | | | | Function Key Data Bit | | | | | Data Expansion | | Mask | Data Determination | |
| D to \bar{D} Common Data Bit | | | | | Reverse in \bar{D} | | | | | | | | | |

Example of Reverse D to \bar{D}

| D | C1 | C2 | C3 | C4 | C5 | C6 | C7 | C8 | C9 | C10 | C11 | C12 | C13 | C14 | C15 |
|-----------|----|----|----|----|----|----|----|----|----|-----|-----|-----|-----|-----|-----|
| | 1 | 0 | 1 | 1 | 0 | 1 | 0 | 0 | 0 | 0 | 0 | 0 | 0 | 1 | 0 |
| \bar{D} | C1 | C2 | C3 | C4 | C5 | C6 | C7 | C8 | C9 | C10 | C11 | C12 | C13 | C14 | C15 |
| | 1 | 0 | 1 | 1 | 0 | 0 | 1 | 1 | 1 | 1 | 1 | 1 | 1 | 0 | 1 |



Input Signals (Recommended Timing)

The computer output signal timing of different types of computer signals are shown below for reference.

For IBM and compatibles

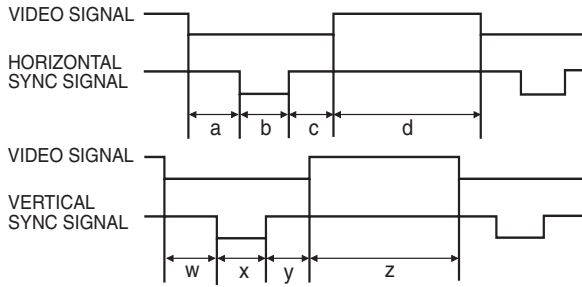

For Macintosh Series

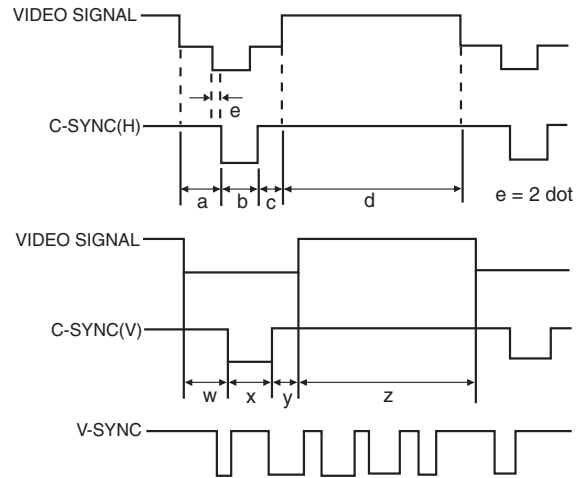

The following is a list of compatible VESA standards. Please note that this projector also accepts signals outside of the VESA standards.

NOTE

- Depending on the mode selected, the projector may clearly display images under 130 Hz.

| | MODE | | VIDEO | | HSYNC | | | | | | | | | VSYNC | | | | | | | | | |
|------|-------------------|-------|-------|-----------------------|---------------|--------|--------------|----------------|--------------|-------|---------|---------|--------|---------|---------------|--------|--------------|----------------|--------------|-------|------|--------|-----|
| | | | | | FRONT PORCH a | SYNC b | BACK PORCH c | VIDEO PERIOD d | 1H (a+b+c+d) | | 1dot | 1/H | 1/dot | LEVEL | FRONT PORCH w | SYNC x | BACK PORCH y | VIDEO PERIOD z | 1V (w+x+y+z) | | 1/V | LEVEL | |
| | dot | line | LEVEL | TYPE | dot | dot | dot | dot | dot | μs | ns | kHz | MHz | H | H | H | H | H | ms | Hz | | | |
| VGA | VESA Standard | 640 | 350 | 0.7 Vp-p 75 Ω load | R • G • B | 32 | 64 | 96 | 640 | 832 | 26.4 | 31.7 | 37.861 | 31.500 | TTL | 32 | 3 | 60 | 350 | 445 | 11.8 | 85.080 | TTL |
| | | 640 | 400 | | | 32 | 64 | 96 | 640 | 832 | 26.4 | 31.7 | 37.861 | 31.500 | | 1 | 3 | 41 | 400 | 445 | 11.8 | 85.080 | |
| | | 720 | 400 | | | 36 | 72 | 108 | 720 | 936 | 26.4 | 28.2 | 37.927 | 35.500 | | 1 | 3 | 42 | 400 | 446 | 11.8 | 85.039 | |
| | Industry Standard | 640 | 480 | | | 8 | 96 | 40 | 640 | 800 | 31.8 | 39.7 | 31.469 | 25.175 | | 2 | 2 | 25 | 480 | 525 | 16.7 | 59.940 | |
| | | 640 | 480 | | | 16 | 40 | 120 | 640 | 832 | 26.4 | 31.7 | 37.861 | 31.500 | | 1 | 3 | 20 | 480 | 520 | 13.7 | 72.809 | |
| | | 640 | 480 | | | 16 | 64 | 120 | 640 | 840 | 26.7 | 31.7 | 37.500 | 31.500 | | 1 | 3 | 16 | 480 | 500 | 13.3 | 75.000 | |
| SVGA | VESA Guidelines | 800 | 600 | | | 24 | 72 | 128 | 800 | 1,024 | 28.4 | 27.8 | 35.156 | 36.000 | | 1 | 2 | 22 | 600 | 625 | 17.8 | 56.250 | |
| | | 800 | 600 | | | 40 | 128 | 88 | 800 | 1,056 | 26.4 | 25.0 | 37.879 | 40.000 | | 1 | 4 | 23 | 600 | 628 | 16.6 | 60.317 | |
| | | 800 | 600 | | | 56 | 120 | 64 | 800 | 1,040 | 20.8 | 20.0 | 48.077 | 50.000 | | 37 | 6 | 23 | 600 | 666 | 13.9 | 72.188 | |
| | VESA Standard | 800 | 600 | | | 16 | 80 | 160 | 800 | 1,056 | 21.3 | 20.2 | 46.875 | 49.500 | | 1 | 3 | 21 | 600 | 625 | 13.3 | 75.000 | |
| | | 800 | 600 | | | 32 | 64 | 152 | 800 | 1,048 | 18.6 | 17.8 | 53.674 | 56.250 | | 1 | 3 | 27 | 600 | 631 | 11.8 | 85.061 | |
| | | 1,024 | 768 | | | 8 | 176 | 56 | 1,024 | 1,264 | 28.2 | 22.3 | 35.522 | 44.900 | | 0 | 4 | 20 | 768 | 817 | 23.0 | 43.479 | |
| XGA | Industry Standard | 1,024 | 768 | | | 24 | 136 | 160 | 1,024 | 1,344 | 20.7 | 15.4 | 48.363 | 65.000 | | 3 | 6 | 29 | 768 | 806 | 16.7 | 60.004 | |
| | | 1,024 | 768 | | | 24 | 136 | 144 | 1,024 | 1,328 | 17.7 | 13.3 | 56.476 | 75.000 | | 3 | 6 | 29 | 768 | 806 | 14.3 | 70.069 | |
| | | 1,024 | 768 | | | 16 | 96 | 176 | 1,024 | 1,312 | 16.7 | 12.7 | 60.023 | 78.750 | | 1 | 3 | 28 | 768 | 800 | 13.3 | 75.029 | |
| | VESA Guidelines | 1,024 | 768 | | | 48 | 96 | 208 | 1,024 | 1,376 | 14.6 | 10.6 | 68.677 | 94.500 | | 1 | 3 | 36 | 768 | 808 | 11.8 | 84.997 | |
| | | 1,152 | 864 | | | 64 | 128 | 256 | 1,152 | 1,600 | 14.8 | 9.3 | 67.500 | 108.000 | | 1 | 3 | 32 | 864 | 900 | 13.3 | 75.000 | |
| | | 1,280 | 960 | | | 96 | 112 | 312 | 1,280 | 1,800 | 16.7 | 9.3 | 60.000 | 108.000 | | 1 | 3 | 36 | 960 | 1,000 | 16.7 | 60.000 | |
| SXGA | VESA Standard | 1,280 | 960 | 64 | 160 | 224 | 1,280 | 1,728 | 11.6 | 6.7 | 85.938 | 148.500 | 1 | 3 | 47 | 960 | 1,011 | 11.8 | 85.002 | | | | |
| | | 1,280 | 1,024 | 48 | 112 | 248 | 1,280 | 1,688 | 15.6 | 9.3 | 63.981 | 108.000 | 1 | 3 | 38 | 1,024 | 1,066 | 16.7 | 60.020 | | | | |
| | | 1,280 | 1,024 | 16 | 144 | 248 | 1,280 | 1,688 | 12.5 | 7.4 | 79.976 | 135.000 | 1 | 3 | 38 | 1,024 | 1,066 | 13.3 | 75.025 | | | | |
| | | 1,280 | 1,024 | 64 | 160 | 224 | 1,280 | 1,728 | 11.0 | 6.3 | 91.146 | 157.500 | 1 | 3 | 44 | 1,024 | 1,072 | 11.8 | 85.024 | | | | |
| | | 1,600 | 1,200 | 64 | 192 | 304 | 1,600 | 2,160 | 13.3 | 6.2 | 75.000 | 162.000 | 1 | 3 | 46 | 1,200 | 1,250 | 16.7 | 60.000 | | | | |
| | | 1,600 | 1,200 | 64 | 192 | 304 | 1,600 | 2,160 | 12.3 | 5.7 | 81.250 | 175.500 | 1 | 3 | 46 | 1,200 | 1,250 | 15.4 | 65.000 | | | | |
| UXGA | VESA Standard | 1,600 | 1,200 | 64 | 192 | 304 | 1,600 | 2,160 | 11.4 | 5.3 | 87.500 | 189.000 | 1 | 3 | 46 | 1,200 | 1,250 | 14.3 | 70.000 | | | | |
| | | 1,600 | 1,200 | 64 | 192 | 304 | 1,600 | 2,160 | 10.7 | 4.9 | 93.750 | 202.500 | 1 | 3 | 46 | 1,200 | 1,250 | 13.3 | 75.000 | | | | |
| | | 1,600 | 1,200 | 64 | 192 | 304 | 1,600 | 2,160 | 9.4 | 4.4 | 106.250 | 229.500 | 1 | 3 | 46 | 1,200 | 1,250 | 11.8 | 85.000 | | | | |
| | | 1,600 | 1,200 | 64 | 192 | 304 | 1,600 | 2,160 | 9.4 | 4.4 | 106.250 | 229.500 | 1 | 3 | 46 | 1,200 | 1,250 | 11.8 | 85.000 | | | | |





Input Signals (Recommended Timing)

| | MODE | | | VIDEO | | HSYNC | | | | | | | | VSYNC | | | | | | | | | | |
|------------|-------------|-------|-------|-----------------------|-----------|-------------------------|-----------|-----------------|-------------------|-----------------------|------|------|--------|---------|-------|------------------|-----------|-----------------|-------------------|-----------------------|------|--------|-------|--------|
| | | | | | | FRONT PORCH a | SYNC b | BACK PORCH c | VIDEO PERIOD d | 1H (a + b + c + d) | | 1dot | 1/H | 1/dot | LEVEL | FRONT PORCH w | SYNC x | BACK PORCH y | VIDEO PERIOD z | 1V (w + x + y + z) | | 1/V | LEVEL | |
| | dot | line | LEVEL | TYPE | dot | dot | dot | dot | dot | μs | ns | kHz | MHz | | H | H | H | H | H | ms | Hz | | | |
| Macintosh™ | 13" Monitor | 640 | 480 | 0.7 Vp-p 75 Ω load | R • G • B | 64 | 64 | 96 | 640 | 864 | 28.6 | 33.1 | 35.000 | 30.2400 | TTL | 3 | 3 | 39 | 480 | 525 | 15.0 | 66.670 | TTL | |
| | 16" Monitor | 832 | 624 | | | 31 | 65 | 224 | 832 | 1,152 | 20.1 | 17.5 | 49.693 | 57.246 | | 1 | 3 | 39 | 624 | 667 | 13.4 | 74.502 | | |
| | 19" Monitor | 1,024 | 768 | | | 35 | 96 | 173 | 1,024 | 1,328 | 16.7 | 12.5 | 60.000 | 79.760 | | 3 | 3 | 30 | 768 | 804 | 13.4 | 74.700 | | |
| | 21" Monitor | 1,152 | 870 | | | 36 | 128 | 140 | 1,152 | 1,456 | 14.5 | 10.0 | 68.887 | 100.300 | | 3 | 3 | 39 | 870 | 915 | 13.3 | 75.287 | | |
| SUN | 66Hz | 1,152 | 900 | | | 29 | 128 | 195 | 1,152 | 1,504 | 14.8 | 10.8 | 61.795 | 92.940 | | 2 | 4 | 31 | 900 | 937 | 14.3 | 69.950 | | |
| | 76Hz | 1,152 | 900 | | | 16 | 96 | 208 | 1,152 | 1,472 | 13.9 | 9.5 | 71.713 | 105.561 | | 2 | 8 | 33 | 900 | 943 | 13.1 | 76.048 | | |
| | 84Hz | 1,152 | 900 | | | 24 | 96 | 168 | 1,024 | 1,312 | 14.1 | 10.8 | 70.838 | 92.940 | | 2 | 8 | 33 | 800 | 843 | 11.9 | 84.031 | | |
| DTV | 480I | 640 | 480 | | | R • G • B/ COMPONENT | - | - | - | - | - | - | - | 15.734 | | - | - | - | - | - | - | - | | - |
| | 480P | 640 | 480 | | - | | - | - | - | - | - | - | - | 31.469 | | - | - | - | - | - | - | - | | 59.940 |
| | 720P | 1,280 | 720 | | - | | - | - | - | - | - | - | - | 44.955 | | - | - | - | - | - | - | - | | 59.740 |
| | 1080I | 1,920 | 1,080 | | - | | - | - | - | - | - | - | - | 33.716 | | - | - | - | - | - | - | - | | 59.940 |

NOTE

- This projector may not be able to display images from notebook computers in simultaneous (CRT/LCD) mode. Should this occur, turn off the LCD display on the notebook computer and output the display data in "CRT only" mode. Details on how to change display modes can be found in your notebook computer's operation manual.
- This projector can receive 640 × 350 VESA format VGA signals, however, "640 × 400" will appear on the screen.
- When receiving 1,600 × 1,200 VESA format UXGA signals, sampling occurs and the image is displayed with 1,024 lines, causing part of the image to be blocked.





Specifications

| | |
|---------------------------------|--|
| Product type | LCD Projector |
| Model | XG-NV6XA |
| Video system | PAL/SECAM/NTSC 3.58/NTSC 4.43/DTV 480P/DTV 720P/DTV 1080I |
| Display method | LCD panel × 3, RGB optical shutter method |
| LCD panel | Panel size: 33 mm (1.3") (20.0 [H] × 26.6 [W] mm) Display method: Translucent TN liquid crystal panel Drive method: TFT (Thin Film Transistor) Active Matrix panel No. of dots: 786,432 dots (1,024 [H] × 768 [V]) |
| Lens | 1–1.3 × zoom lens, F1.7–2.3, f = 49.1–63.8 mm |
| Projection lamp | 150 W UHP lamp |
| Contrast ratio | 250:1 |
| Video input signal | RCA Connector: VIDEO, composite video, 1.0 Vp-p, sync negative, 75 Ω terminated RCA Connector: AUDIO, 0.5 Vrms more than 22 kΩ (stereo) |
| S-video input signal | 4-pin Mini DIN connector Y (luminance signal): 1.0 Vp-p, sync negative, 75 Ω terminated C (chrominance signal): Burst 0.286 Vp-p, 75 Ω terminated |
| Component input signal | BNC Connector (INPUT 1) Y: 1.0 Vp-p, sync negative, 75 Ω terminated Pb: 0.7 Vp-p, 75 Ω terminated Pr: 0.7 Vp-p, 75 Ω terminated |
| Horizontal resolution | 520 TV lines (video input), 750 TV lines (DTV 720P input, Dot by Dot) |
| Audio output | 2 W + 2 W (stereo) |
| Computer RGB input signal | 15-PIN MINI D-SUB CONNECTOR (INPUT 1, 2), 5 BNC CONNECTOR (INPUT 1): RGB separate/composite sync/sync on green type analog input: 0–0.7 Vp-p, positive, 75 Ω terminated STEREO MINIJACK: AUDIO, 0.5 Vrms, more than 22 kΩ (stereo) HORIZONTAL SYNC. SIGNAL: TTL level (positive/negative) or composite sync (Apple only) VERTICAL SYNC. SIGNAL: Same as above |
| Pixel clock | 12–230 MHz |
| Vertical frequency | 43–200 Hz |
| Horizontal frequency | 15–126 kHz |
| Computer control signal | 9-pin Mini DIN male connector (RS-232C Input Port) |
| Speaker system | 1 3 ¹ / ₂ " (5 cm) round × 2 |
| Rated voltage | AC 110–120/220–240 V |
| Input current | 2.4 A/1.2 A |
| Rated frequency | 50/60 Hz |
| Power consumption | 265 W |
| Operating temperature | +5°C to +40°C |
| Storage temperature | –20°C to +60°C |
| Cabinet | Plastic |
| I/R carrier frequency | 38 kHz |
| Laser pointer of remote control | Wave length: 650 nm / Max. output: 1 mW / Class II Laser Product |
| Dimensions (approx.) | 261 × 129 × 356 mm (W × H × D) (main body only) 261 × 146 × 411.5 mm (W × H × D) (including adjustment feet and projecting parts) |
| Weight (approx.) | 7.2 kg |
| Supplied accessories | Remote control, Two AA size batteries, Power cord (3.6 m), Computer cable (3 m), Three BNC-RCA adaptors, Computer audio cable (3 m), Mouse control serial cable (1 m), Mouse control cable for IBM PS/2 (1 m), Mouse control cable for Mac (17 cm), DIN-D-sub RS-232C cable (15 cm), Remote mouse receiver, Extra air filter, Lens cap (attached), CD-ROM, LCD projector operation manual, LCD projector quick reference, Sharp Advanced Presentation Software operation manual, Sharp Advanced Presentation Software quick reference, IrDA driver installation instruction sheet |
| Replacement parts | Standard lens unit (CLNS-0169CE01), Remote control (RRMCG1547CESA), AA size batteries, Power cord, Computer cable (QCNW-5304CEZZ), BNC-RCA adaptors (QPLGJ0107GEZZ), Computer audio cable (QCNW-4870CEZZ), Mouse control serial cable (QCNW-5112CEZZ), Mouse control cable for IBM PS/2 (QCNW-5113CEZZ), Mouse control cable for Mac (QCNW-5114CEZZ), DIN-D-sub RS-232C cable (QCNW-5288CEZZ), Remote mouse receiver (RUNTK0661CEZZ), Air filter (PFILD0080CEZZ), Lens cap (PCAPH1056CESA), CD-ROM, LCD projector operation manual, LCD projector quick reference, Sharp Advanced Presentation Software operation manual, Sharp Advanced Presentation Software quick reference, IrDA driver installation instruction sheet |

This SHARP projector uses LCD (Liquid Crystal Display) panels. These very sophisticated panels contain 786,432 pixels (× RGB) TFTs (Thin Film Transistors). As with any high technology electronic equipment such as large screen TVs, video systems and video cameras, there are certain acceptable tolerances that the equipment must conform to.

This unit has some inactive TFTs within acceptable tolerances which may result in illuminated or inactive dots on the picture screen. This will not affect the picture quality or the life expectancy of the unit.

Specifications are subject to change without notice.





Dimensions

Rear View

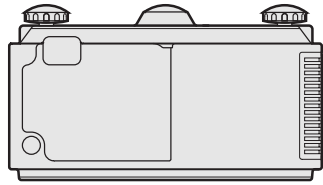

Top View

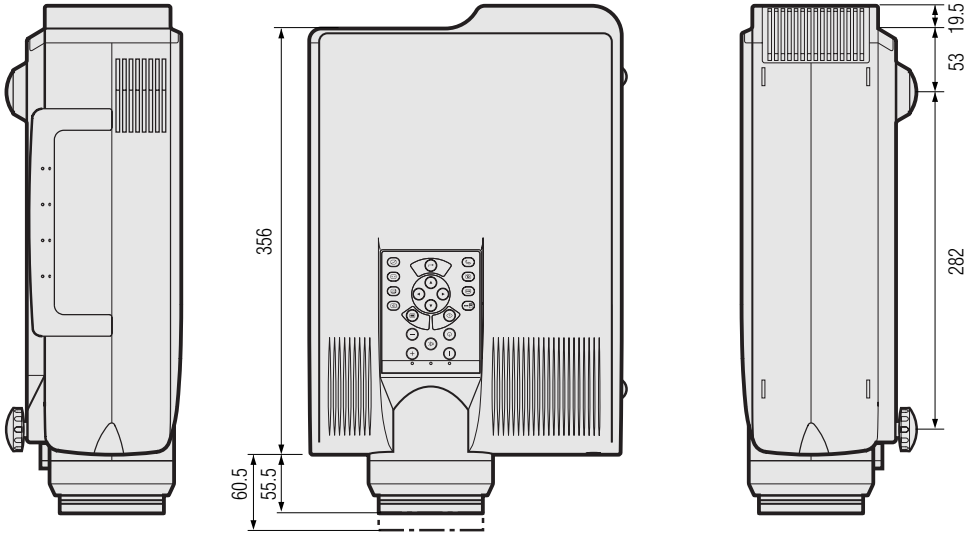

Side View

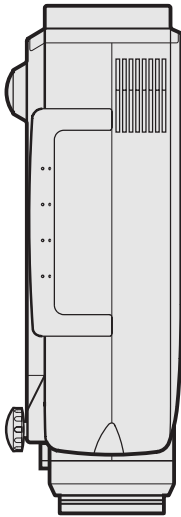

Front View

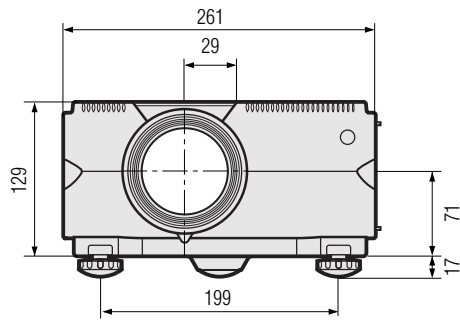

Bottom View

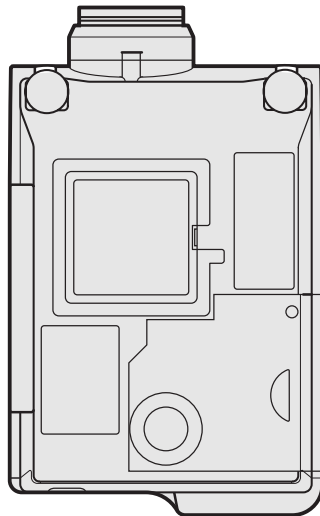

Units: mm



Guide to Effective Presentations

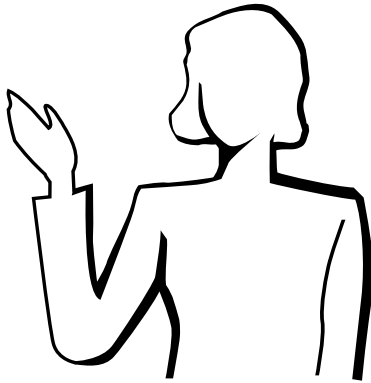

Electronic presentations are one of the most effective tools presenters can use to persuade an audience. There are several ways to enhance your presentation and maximise your effectiveness. The following are guidelines to help you create and deliver a dynamic presentation.

a. Types of Presentations

Computer Presentations

- To present basic information such as graphs, spreadsheets, documents and images, use word processing and spreadsheet applications.
- To convey more complex information and create more dynamic presentations which allow you to control the pace of your delivery, utilise software such as Astound®, Freelance®, Persuasion® or PowerPoint®.
- For high-end multimedia and interactive presentations, use software such as Macromedia Director®.

NOTE

- Astound®, Freelance®, Persuasion®, PowerPoint® and Macromedia Director® are trademarks of their respective companies.

Video Presentations

Use of video equipment, such as a VCR, DVD player and laser disc player, can be effective for delivering instructional or illustrative information that is difficult to present.

Digital Cameras and Personal Digital Assistants (PDAs)

For highly compact and portable presentations, still cameras, digital video cameras, document cameras and PDAs are ideal for transferring data without cumbersome conversions.

Multimedia Presentations

You can integrate all of the above methods for a full multimedia presentation including video, audio, computer applications and World Wide Web information.

Wireless Presentations

Use any IrDA/IrTran-P compatible source such as a laptop, digital camera or PDA to project still images quickly and effortlessly without the use of cables.

b. Creative Presentations

Oftentimes presenters do not take advantage of the many subtle ways they can manipulate their electronic slides to more effectively persuade the audience.

Colour has a great effect on the audience during a presentation. When used correctly and legibly, studies show that background & foreground colours establish an emotional tone for a presentation, help viewers understand and retain information, and influence an audience to take a desired course of action.

Colour Considerations

- Choose legible colours.
- Text and graphics colours need sufficient contrast.
- Use darker colours for the background since a lighter background can create uncomfortable glare. (Yellow on black creates an ideal contrast.)

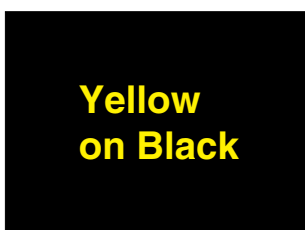
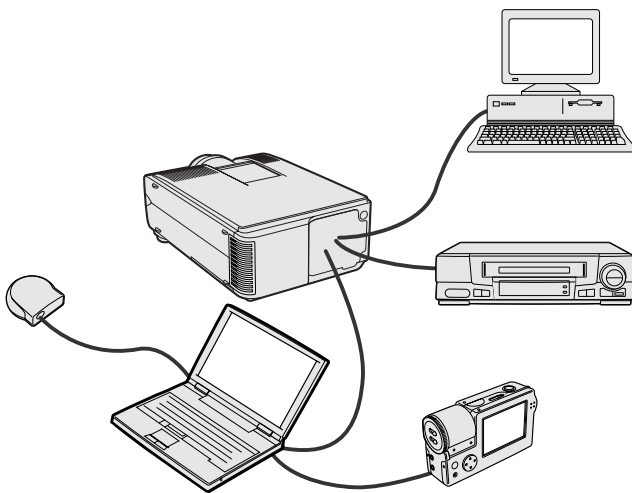
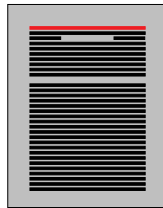
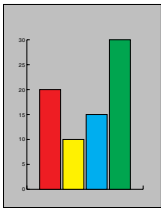

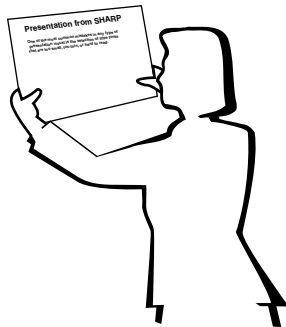
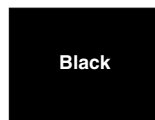
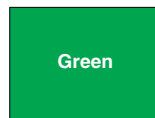

- Background colours can subconsciously affect the audience:

Red—increases viewers' pulse and breathing and encourages risk taking but can also be associated with financial loss.

Blue—has a calming and conservative affect on the audience but can also create boredom among corporate audiences that are often inundated with this background colour.

Green—stimulates interaction.

Black—conveys finality and certainty. Use it as a transitional colour between slides when moving from one idea to another.

- Foreground colours create a major impact on how well an audience understands and remembers a message.
 - Use one or two bright colours for emphasis.
 - Highlight important messages.
- The eye has a difficult time reading certain coloured text on certain coloured backgrounds. For example, text and background colours in red and green, and blue and black make for difficult viewing.
- Colourblind individuals may find it difficult to distinguish between red and green, brown and green, and purple and blue. Avoid using these colours together.

Fonts

- One of the most common mistakes in any type of presentation visual is the selection of type fonts that are too small, too thin, or too difficult to read.
- If you are not sure how well a given font will read on a screen at various sizes, try this: Draw a 15 cm × 20 cm box on a piece of paper and print out several lines of text inside the box with your computer printer at 300 or 600 dpi resolution. Vary the sizes of text to simulate headline, body and text call-outs for any charts or graphs. Hold the printout at arm's length. This is how your text will look on a 1.2 meters-wide screen at 3 meters, on a 2.3 meters-wide screen at 6.1 meters and a 3.7 meters-wide screen at 9.1 meters. If you cannot read the text easily, you should put less copy on your visuals or use larger typefaces.
- Design your visuals so that they are visible by the viewer in the last row.
- Nothing will ruin your presentation faster than misspelled words. Take the time to proofread and edit your work before your visuals become a permanent part of your presentation.
- Mixed case text is easier to read than text which is displayed in capital letters.
- Another important attribute of fonts is whether any particular face is serif or sans-serif. Serifs are small, usually horizontal cross strokes that are added to the end of a letter's main strokes. Because of their ability to coax the eye along the line of type, fonts with serifs are generally acknowledged to be more readable.

Sans-serif
Serif



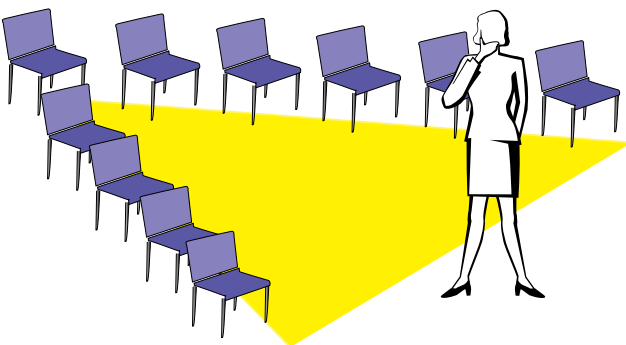
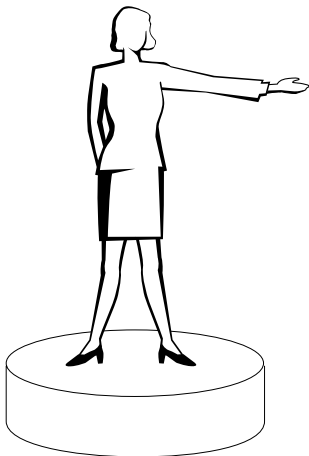
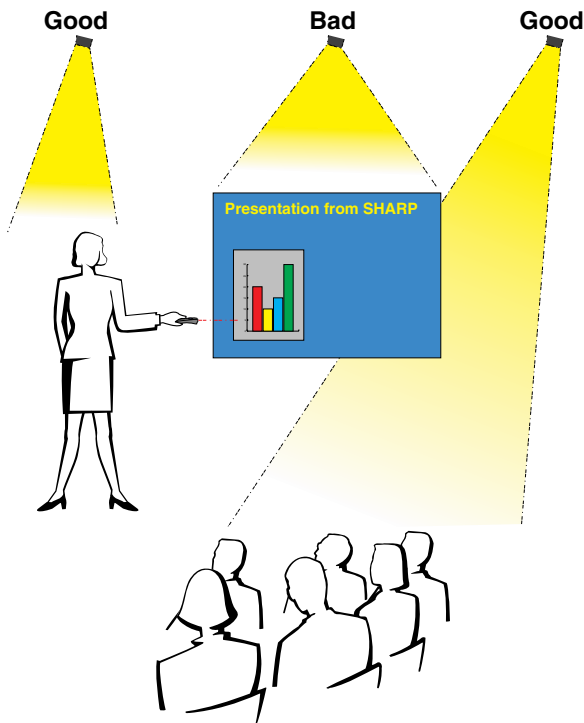

c. Set-Up

When giving a presentation, you need to set the stage both figuratively and literally for success. The way you set up a presentation room will have a great impact on the audience's perception of you and your message. By manipulating the placement and use of the following tools, you will improve the impact of your presentation.

Lighting—Good lighting is an important component of a successful presentation. You should strive to create an unequal distribution of light. An audience should always see as much of the presenter's face as possible, so most of the light should be focused on you. Because it is important for you to be able to read the audience's faces and body language, some light should be shed upon them. However, no light should shine on the screen.

Stage—When presenting on the same level surface that your audience is on, most people can only see the top one-third of your body. Therefore, it is recommended that when giving a presentation to an audience of 25 or more, you stand on a stage or platform. As more of your body is visible, the easier it is to communicate with an audience.

Podiums—The best presenters avoid podiums because they hide 75% of the body and restrict movement. However, many people feel more comfortable with a podium to hold their notes and hide their discomfort. If you must use a podium, angle it at 45 degrees to the audience so that you are not completely hidden.

Visuals—It is imperative that you make sure your visuals are large enough and projected far enough for the audience to see. Eight times the height of an image is the optimal viewing distance to read 24 point type. The bottom of a screen should be at least 1.8 meters above the floor.

Screen—The screen should always be in the centre of the room so that all audience members can see it. Because people read from left to right, you should always stand to the audience's left when discussing visuals.

Seating—Arrange seating according to the dynamics of your presentation. If the presentation is more than half-a-day, use classroom style seating—a chair and a desk. If you would like to encourage audience interaction, use chevron seating, angling the chairs into a "V" shape. When you have a very small audience, a "U" shaped arrangement will increase interchange.





d. Rehearsing & Delivery

- The best time to rehearse is the day or evening before, not a couple of hours before, and the best place to rehearse is in the actual room. Rehearsing a speech in a small office is not the same as standing up in front of 100 people in a hotel ballroom or classroom.
- Due to varying processor speeds of computers, practice your slide transitions for proper timing.
- Whenever possible, set up your equipment well in advance to allow adequate time to resolve any unexpected issues such as lighting, power, seating and audio.
- Thoroughly check every piece of equipment you bring along. Make sure you have fresh batteries in your remote controls and laptop computer. Fully charge your computer's battery before the presentation and connect your AC adaptor for added safety.
- Make sure you are completely familiar with the control panel on your projector and remote controls.
- If you are using a microphone, check it out before hand and walk around to see where you might have problems with feedback. Avoid standing in these problem areas during your presentation.

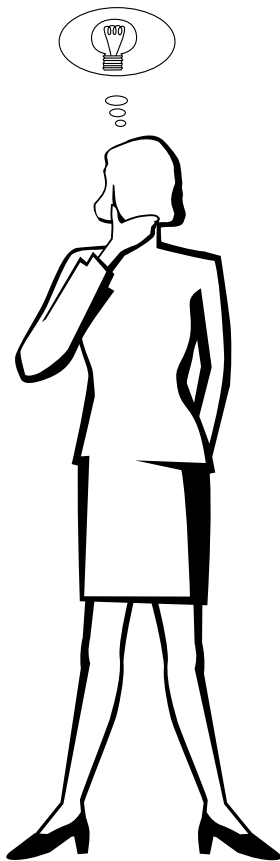

e. Presentation Tips

- Before beginning, visualise yourself delivering an outstanding presentation.
- Know your speech, memorising at least the first three minutes of your presentation will allow you to focus on your rhythm and pacing.
- Speak to early arrivals to help you build a rapport with the audience and make you feel more comfortable.
- Do not be overly dependent on your visuals by reciting what your audience is already reading. Know your material well enough to be able to deliver the presentation with ease. Use your visuals to emphasise keypoints.
- Be sure to project your voice clearly and use eye contact to maintain audience attention.
- Do not wait until halfway through your presentation to get your point across. If you wait and try to create a "build-up", you may lose some of your audience along the way.
- Keep your audience's attention. As most people only focus for 15 to 20 minutes during a one-hour presentation, it is important to recapture their attention periodically. Use phrases like, "This is critical to my point" or "This is absolutely fundamental" to remind them you are saying something they need to hear.





Glossary

Aspect ratio

Width and height ratio of an image. The normal aspect ratio of a computer and video image is 4 : 3. There are also wide images with an aspect ratio of 16 : 9 and 21 : 9.

Auto sync

Optimises projected computer images by automatically adjusting certain characteristics.

Background

Initial setting image projected when no signal is being input.

Clock

Clock adjustment is used to adjust vertical noise when clock level is incorrect.

Compatibility

Ability to use with various image signal modes.

Composite sync

Signal combining horizontal and vertical sync pulses.

Digital keystone correction

Function to digitally correct a distorted image when the projector is set up at an angle.

Dot by dot

Mode that projects images in their native resolution.

DTV

The umbrella term used to describe the new digital television system in the united states.

Fit to screen

Function to adjust an image without keeping a native aspect ratio other than 4 : 3, and project it in a 4 : 3 ratio.

Freeze

Function to freeze a moving image.

GUI

Graphical User Interface. User interface with graphics that allow easier operation.

I/P conversion

Function to convert an image between "Interlaced" and "Progressive" scan displays.

Intelligent compression and expansion

High quality resizing of lower and higher resolution images to fit the projector's native resolution.

IrCOM

Function to transmit still images from a computer, hand-held PC or digital still camera via infrared communication for "Wireless Presentations".

IrDA

Standard protocol for wireless communication.

IrTran-P

Standard format (protocol) for transmission of images.

Magnification

Digitally zooms in on a portion of an image.

PDF

Portable Document Format. Documentation format used to transfer text and images from the CD-ROM.

Phase

Phase shift is a timing shift between isomorphic signals with the same resolution. When phase level is incorrect, the projected image typically displays horizontal flicker.

Presentation tools

Helpful tools used to emphasise keypoints throughout a presentation.

RS-232C

Function to control the projector from the computer by using the RS-232C ports on the projector and computer.

Startup image

The image displayed when the projector is turned on.

Status function

Displays the settings of each adjustment item.

Sync

Synchronises the resolution and phase shift of two signals. When receiving an image with a resolution different from that of the computer, the projected image may be distorted.

Sync on green

Video signal mode of a computer which overlaps horizontal and vertical sync signal to green colour signal pin.

Wireless mouse

Function to operate the mouse control of the computer with the supplied remote control.

XGA resolution

The resolution with 1,024 × 768 pixels that uses the signal of an IBM/AT compatible (DOS/V) computer.





Index

| | |
|---|----|
| A | |
| AC socket | 11 |
| ADJUSTMENT buttons | 23 |
| Air filter | 46 |
| Aspect ratio | 36 |
| Audio adjustments | 28 |
| AUDIO INPUT 1 terminal | 11 |
| AUDIO INPUT 2 terminal | 11 |
| AUDIO INPUT terminals | 13 |
| AUDIO OUTPUT terminal | 14 |
| Automatic power shutoff function | 38 |
| Auto sync adjustment | 30 |
| AUTO SYNC button | 29 |
| B | |
| Background | 41 |
| BACKLIGHT button | 22 |
| BLACK SCREEN button | 37 |
| BNC-RCA adaptors | 13 |
| C | |
| Carrying handle | 49 |
| Ceiling-mount | 20 |
| Ceiling + Rear | 42 |
| Clock | 29 |
| Computer audio cable | 11 |
| Computer cable | 11 |
| Cooling fan (Exhaust vent) | 5 |
| Cooling fan (Intake vent) | 7 |
| D | |
| Digital keystone correction | 3 |
| DIN-D-sub RS-232C cable | 14 |
| Dot by dot | 36 |
| DTV | 3 |
| E | |
| ENLARGE button | 34 |
| ENTER button | 23 |
| Extra air filter | 10 |
| F | |
| 15 pin/BNC switch | 11 |
| Fit to screen | 36 |
| Foot releases | 19 |
| FREEZE button | 33 |
| G | |
| GAMMA button | 35 |
| GUI (Graphical User Interface) | 23 |
| I | |
| INPUT 1 port | 11 |
| INPUT 1 terminals | 12 |
| INPUT 2 port | 11 |
| INPUT button | 17 |
| Intelligent compression and expansion | 3 |
| I/P conversion | 39 |
| IrCOM | 25 |
| IrCOM button | 25 |
| IrCOM sensors | 25 |
| IrDA | 58 |
| IrTran-P | 58 |
| K | |
| Kensington Security Standard connector | 48 |
| L | |
| LAMP REPLACEMENT indicator | 47 |
| LASER POINTER button | 22 |
| Laser pointer window | 5 |
| LEFT-CLICK button | 22 |
| LENS button | 19 |
| Lens cap | 49 |
| M | |
| MENU button | 23 |
| MOUSE/ADJUSTMENT switch | 21 |
| MOUSE buttons | 22 |
| Mouse control cable for IBM PS/2 | 15 |
| Mouse control cable for Mac | 15 |
| Mouse control serial cable | 15 |
| MUTE button | 17 |
| O | |
| On-screen display language | 26 |
| OUTPUT port | 7 |
| P | |
| PDF | 6 |
| Phase | 29 |
| Picture adjustments | 27 |
| POWER buttons | 17 |
| Power cord | 11 |
| POWER indicator | 16 |
| Presentation tools | 43 |
| R | |
| Rear projection | 20 |
| Remote control | 21 |
| Remote control sensor | 21 |
| Remote control signal transmitter | 8 |
| Remote mouse receiver | 21 |
| RESIZE button | 36 |
| RIGHT-CLICK button | 22 |
| RS-232C port | 14 |
| S | |
| Sharp Advanced Presentation Software (SAPS) | 25 |
| Speakers | 7 |
| Startup image | 41 |
| Status function | 44 |
| S-VIDEO INPUT terminal | 13 |
| Sync | 30 |
| Sync on green | 50 |
| T | |
| TEMPERATURE WARNING indicator | 47 |
| TOOLS button | 43 |
| U | |
| UNDO button | 19 |
| V | |
| VIDEO INPUT terminal | 13 |
| VOLUME buttons | 17 |
| W | |
| Wired remote control input | 22 |
| WIRED REMOTE control input terminal | 22 |
| Wireless mouse | 21 |
| X | |
| XGA resolution | 3 |



SHARP CORPORATION

Osaka, Japan