

SHARP®



OPERATION MANUAL



MODEL XG-NV6XU

LCD PROJECTOR

NOM 1245  NYCE



Important Information



Setup & Connections



Operation



Useful Features



Maintenance & Troubleshooting



Appendix



Before using the LCD projector, please read this operation manual carefully.

OPERATION MANUAL

ENGLISH

IMPORTANT

For your assistance in reporting the loss or theft of your Color LCD Projector, please record the Serial Number located on the bottom of the projector and retain this information. Before recycling the packaging, please be sure that you have checked the contents of the carton thoroughly against the list of "Supplied Accessories" on page 10.

Model No.: XG-NV6XU

Serial No.:

There are two important reasons for prompt warranty registration of your new SHARP LCD Projector, using the REGISTRATION CARD packed with the projector.

1. WARRANTY

This is to assure that you immediately receive the full benefit of the parts, service and labor warranty applicable to your purchase.



2. CONSUMER PRODUCT SAFETY ACT

To ensure that you will promptly receive any safety notification of inspection, modification, or recall that SHARP may be required to give under the 1972 Consumer Product Safety Act, PLEASE READ CAREFULLY THE IMPORTANT "LIMITED WARRANTY" CLAUSE.

U.S.A. ONLY

WARNING: High brightness light source. Do not stare into the beam of light, or view directly. Be especially careful that children do not stare directly into the beam of light.

WARNING: To reduce the risk of fire or electric shock, do not expose this product to rain or moisture.

	CAUTION RISK OF ELECTRIC SHOCK. DO NOT REMOVE SCREWS EXCEPT SPECIFIED USER SERVICE SCREW.	
CAUTION: TO REDUCE THE RISK OF ELECTRIC SHOCK, DO NOT REMOVE COVER. NO USER-SERVICEABLE PARTS EXCEPT LAMP UNIT. REFER SERVICING TO QUALIFIED SERVICE PERSONNEL.		



The lightning flash with arrowhead symbol, within an equilateral triangle, is intended to alert the user to the presence of uninsulated "dangerous voltage" within the product's enclosure that may be of sufficient magnitude to constitute a risk or electric shock to persons.



The exclamation point within a triangle is intended to alert the user to the presence of important operating and maintenance (servicing) instructions in the literature accompanying the product.

WARNING: FCC Regulations state that any unauthorized changes or modifications to this equipment not expressly approved by the manufacturer could void the user's authority to operate this equipment.

U.S.A. ONLY

INFORMATION

This equipment has been tested and found to comply with the limits for a Class A digital device, pursuant to Part 15 of the FCC Rules. These limits are designed to provide reasonable protection against harmful interference when the equipment is operated in a commercial environment. This equipment generates, uses, and can radiate radio frequency energy and, if not installed and used in accordance with the operation manual, may cause harmful interference to radio communications. Operation of this equipment in a residential area is likely to cause harmful interference, in which case the user will be required to correct the interference at his own expense.

U.S.A. ONLY

The enclosed computer cable must be used with the device. The cable is provided to ensure that the device complies with FCC Class A verification.

U.S.A. ONLY



Important Safeguards



Electrical energy can perform many useful functions. This product has been engineered and manufactured to ensure your personal safety. But IMPROPER USE CAN RESULT IN POTENTIAL ELECTRICAL SHOCK OR FIRE HAZARD. In order not to defeat the safeguards incorporated into this LCD Projector, observe the following basic rules for its installation, use and servicing. For your own protection and reliable usage of your LCD Projector, please be sure to read these "Important Safeguards" carefully before use.

1. Read Instructions

All the safety and operating instructions should be read before the product is operated.

2. Retain Instructions

The safety and operating instructions should be retained for future reference.

3. Heed Warnings

All warnings on the product and in the operating instructions should be adhered to.

4. Follow Instructions

All operating and use instructions should be followed.

5. Cleaning

Unplug this product from the wall outlet before cleaning. Do not use liquid cleaners or aerosol cleaners. Use a damp cloth for cleaning.

6. Attachments

Do not use attachments not recommended by the product manufacturer as they may cause hazards.

7. Water and Moisture

Do not use this product near water—for example, near a bathtub, wash bowl, kitchen sink, or laundry tub; in a wet basement; or near a swimming pool; and the like.

8. Accessories

Do not place this product on an unstable cart, stand, tripod, bracket, or table. The product may fall, causing serious injury to a child or adult, and serious damage to the product. Use only with a cart, stand, tripod, bracket, or table recommended by the manufacturer, or sold with the product. Any mounting of the product should follow the manufacturer's instructions, and should use a mounting accessory recommended by the manufacturer.

9. Transportation

A product and cart combination should be moved with care. Quick stops, excessive force, and uneven surfaces may cause the product and cart combination to overturn.



10. Ventilation

Slots and openings in the cabinet are provided for ventilation to ensure reliable operation of the product and to protect it from overheating. The openings should never be covered or blocked by placing the product on a bed, sofa, rug, or other similar surface. This product should not be placed in a built-in installation such as a bookcase or rack unless proper ventilation is provided or the manufacturer's instructions have been adhered to.

11. Power Sources

This product should be operated only from the type of power source indicated on the marking label. If you are not sure of the type of power supply to your home, consult your product dealer or local power company. For products intended to operate from battery power, or other sources, refer to the operating instructions.

12. Grounding or Polarization

This product is equipped with a three-wire grounding-type plug, a plug having a third (grounding) pin. This plug will only fit into a grounding-type power outlet. This is a safety feature. If you are unable to insert the plug into the outlet, contact your electrician to replace your obsolete outlet. Do not defeat the safety purpose of the grounding-type plug.

13. Power-Cord Protection

Power-supply cords should be routed so that they are not likely to be walked on or pinched by items placed upon or against them, paying particular attention to cords at plugs, convenience receptacles, and the point where they exit from the product.

14. Lightning

For added protection for this product during a lightning storm, or when it is left unattended and unused for long periods of time, unplug it from the wall outlet and disconnect the cable system. This will prevent damage to the product due to lightning and power-line surges.

15. Overloading

Do not overload wall outlets, extension cords, or integral convenience receptacles as this can result in a risk of fire or electric shock.

16. Object and Liquid Entry

Never push objects of any kind into this product through openings as they may touch dangerous voltage points or short-out parts that could result in a fire or electric shock. Never spill liquid of any kind on the product.

17. Servicing

Do not attempt to service this product yourself as opening or removing covers may expose you to dangerous voltage or other hazards. Refer all servicing to qualified service personnel.

18. Damage Requiring Service

Unplug this product from the wall outlet and refer servicing to qualified service personnel under the following conditions:

- If the power-supply cord or plug is damaged.
- If liquid has been spilled, or objects have fallen into the product.
- If the product has been exposed to rain or water.
- If the product does not operate normally by following the operating instructions. Adjust only those controls that are covered by the operating instructions, as an improper adjustment of other controls may result in damage and will often require extensive work by a qualified technician to restore the product to normal operation.
- If the product has been dropped or damaged in any way.
- If the product exhibits a distinct change in performance, this indicates a need for service.

19. Replacement Parts

When replacement parts are required, be sure the service technician has used replacement parts specified by the manufacturer or with the same characteristics as the original part. Unauthorized substitutions may result in fire, electric shock, or other hazards.

20. Safety Check

Upon completion of any service or repairs to this product, ask the service technician to perform safety checks to determine that the product is in proper operating condition.

21. Wall or Ceiling Mounting

This product should be mounted to a wall or ceiling only as recommended by the manufacturer.

22. Heat

This product should be situated away from heat sources such as radiators, heat registers, stoves, or other products (including amplifiers) that produce heat.



Outstanding Features

1. **ADVANCED COMPATIBILITY WITH HIGH-END WORKSTATIONS AND PCS**

Compatible with up to 200 Hz vertical refresh rate, Sync on Green and Composite Sync signals for use with a wide variety of high-end PCs and Workstations. (Page 11)

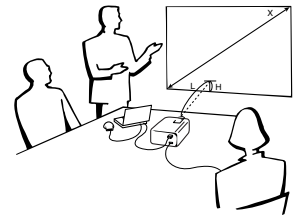

2. **FOR USE WITH DTV**

Allows projection of DTV images and 16:9 wide-screen images when connected to a DTV decoder or similar video systems. (Page 13)

3. **BNC TERMINALS FOR COMPONENT AND RGB INPUT**

Equipped with BNC terminals for connection to a DTV decoder, DVD player and similar video systems for higher quality images. An RCA adaptor can also be used with the BNC terminals. (Page 13)

4. **3-D Y/C DIGITAL COMB FILTER**

Provides high quality images with minimal dot crawl and cross color noise.

5. **POWER ZOOM AND FOCUS FUNCTION**

Features a 130% power zoom function that allows you to easily adjust the screen size with the remote control. Use these functions when adjusting the projection distance to achieve a 40- to 300-inch screen size. (Page 19)

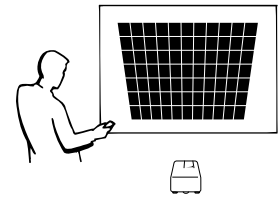

6. **DIGITAL KEYSTONE CORRECTION**

Digitally adjusts an image that is projected at an angle while maintaining image quality and brightness. (Page 19)

7. **EASY-TO-USE GRAPHICAL USER INTERFACE (GUI)**

A multi-color, icon based menu system allows for simple image adjustments. (Page 23)

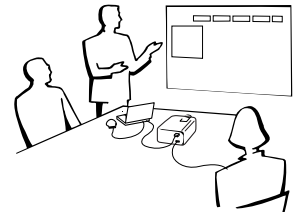

8. **USER-FRIENDLY DESIGN**

The two-color design along with an intuitive Graphical User Interface (GUI) makes this projector very easy to set up and adjust.

9. **WIRELESS PRESENTATIONS WITH IrCOM**

The IrCOM function allows for wireless transmission of digital images via infrared communication from a PC or digital camera. (Page 25)



10. **AUTO SYNC TECHNOLOGY FOR AUTOMATIC IMAGE PERFECTION**

Automatically makes any necessary adjustments for perfectly synced computer images. (Page 29)

11. **INTELLIGENT COMPRESSION AND EXPANSION**

By using intelligent resizing technology, this projector can display higher and lower resolution images in detail without compromising quality. (Page 36)

12. **XGA RESOLUTION FOR HIGH RESOLUTION PRESENTATIONS**

With XGA (1,024 × 768) resolution, this projector can display very detailed presentation information.

13. **UXGA COMPATIBLE**

UXGA (1,600 × 1,200) resolution images are intelligently resized to 1,024 × 768 for full-screen or default presentations.

14. **CUSTOMIZABLE STARTUP SCREEN**

Allows you to load a custom startup image (i.e. your company logo) to be displayed while the projector is warming up. (Page 41)

15. **BUILT-IN PRESENTATION TOOLS**

A variety of helpful presentation utilities are incorporated to enhance presentations. These include “Stamp” functions, “Break Timer”, and “Digital Enlarge”. (Page 43)



Contents

Important Information

Important Safeguards	2
Outstanding Features	3
Contents	4
Usage Guidelines	5
How to Access the PDF Operation Manuals (for Windows and Macintosh)	6
For SHARP Assistance (U.S.A. only)	6
Part Names	7

Setup & Connections

Setting up the Projector	10
1. Supplied Accessories	10
2. Connecting the Projector	11

Operation

Basic Operations	16
1. Turning on/off the Power	16
2. Setting up the Screen	18
3. Operating the Wireless Mouse from the Remote Control	21
Using the GUI (Graphical User Interface) Menu Screens	23
Using IrCOM for Wireless Presentations	25
Selecting the On-screen Display Language ...	26
Selecting the Video Input System Mode (VIDEO mode only)	26
Picture Adjustments	27
Audio Adjustments	28
Computer Image Adjustments	29
Auto Sync Adjustment	30
Auto Sync Display Function	30
Saving and Selecting Adjustment Settings ...	31
Special Mode Adjustment	32

Useful Features

Freeze Function	33
Digital Image Magnification	34
Gamma Correction	35
Selecting the Picture Display Mode	36
Black Screen Function	37
On-screen Display Override Function	37
Selecting the Economy Mode	38
I/P Conversion	39
Checking the Lamp Usage Time	39
Selecting the Signal Type	40
Checking the Input Signal	40
Setting a Background Image	41
Selecting a Startup Image	41
Reverse/Invert Image Function	42
Using the Presentation Tools	43
Status Function	44

Maintenance & Troubleshooting

Air Filter Maintenance	46
Lamp/Maintenance Indicators	47
Replacing the Projection Lamp	48
Using the Kensington Lock	49
Troubleshooting	49

Appendix

Optional Lenses	50
Transporting the Projector	50
Connection Pin Assignments	51
RS-232C Port Specifications	52
Wired Remote Control Terminal Specifications	54
Input Signals (Recommended Timing)	55
Specifications	57
Dimensions	58
Guide to Effective Presentations	59
Glossary	63
Index	64



Usage Guidelines

CAUTION LASER RADIATION- DO NOT STARE INTO BEAM  WAVE LENGTH : 650nm MAX. OUTPUT : 1mW CLASS II LASER PRODUCT	*COMPLIES WITH 21 CFR SUBCHAPTER J* SHARP ELECTRONICS CORPORATION SHARP PLAZA, MAHWAH, NEW JERSEY 07430 TEL : 1-800-BE-SHARP (U.S.A. ONLY)
	REMOTE CONTROL MODEL NO. : RRHC01918CE5A DC9V (1.5X2XPC-5) MADE IN CHINA FABRIQUE AU CHINE

AVOID EXPOSURE-LASER RADIATION IS EMITTED FROM THIS APERTURE.

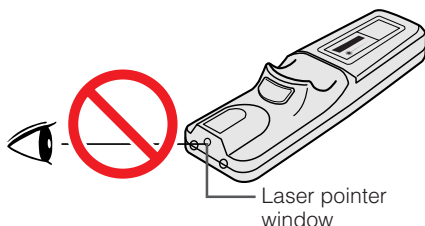
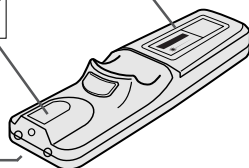

Cautions Concerning the Laser Pointer

The laser pointer on the remote control emits a laser beam from the laser pointer window. This is a Class II laser which may impair your sight if directed into the eyes. The three marks shown on the left are caution labels for the laser beam.

- Do not look into the laser pointer window or shine the laser beam on yourself or others. (The laser beam used in this product is harmless when directed onto the skin. However, be careful not to project the beam directly into the eyes.)
- Always use the laser pointer at temperatures between 41°F and 104°F (+5°C and +40°C).
- Use of controls or adjustments, or performance of procedures other than those specified herein may result in hazardous radiation exposure.

Cautions Concerning the Setup of the Projector

For minimal servicing and to maintain high image quality, SHARP recommends that this projector be installed in an area free from humidity, dust and cigarette smoke. When the projector is subjected to these environments, the lens and filter must be cleaned more often. Periodically the filter should be replaced and the projector should be cleaned internally. As long as the projector is properly maintained in this manner, use in these environments will not reduce the overall operation life. Please note that all internal cleaning must be performed by an Authorized Sharp Industrial LCD Products Dealer or Service Center.

Notes on Operation

- The exhaust vent, the lamp cage cover and adjacent areas may be extremely hot during projector operation. To prevent injury, do not touch these areas until they have sufficiently cooled.
- Allow at least 4 inches (10 cm) of space between the cooling fan (exhaust vent) and the nearest wall or obstruction.
- If the cooling fan becomes obstructed, a protection device will automatically turn off the projector lamp. This does not indicate a malfunction. Remove the projector power cord from the wall outlet and wait at least 10 minutes. Then turn on the power by plugging the power cord back in. This will return the projector to the normal operating condition.

Temperature Monitor Function

If the projector starts to overheat due to setup problems or a dirty air filter, "TEMP." and "X" will flash in the lower-left corner of the picture. If the temperature continues to rise, the lamp will turn off, the TEMPERATURE WARNING indicator on the projector will flash, and after a 90-second cooling-off period the power will shut off. Refer to "Lamp/Maintenance Indicators" on page 47, for details.

NOTE

- The cooling fan regulates the internal temperature, and its performance is automatically controlled. The sound of the fan may change during projector operation due to changes in the fan speed.



How to Access the PDF Operation Manuals (for Windows and Macintosh)



PDF operation manuals in all languages are included in the CD-ROM. To utilize these manuals, you need to install Adobe Acrobat Reader on your PC (Windows or Macintosh). If you have not installed Acrobat Reader yet, you can download it from the Internet (<http://www.adobe.com>) or install it from the CD-ROM.

To Install Acrobat Reader from the CD-ROM

For Windows:

- ① Insert the CD-ROM in the CD-ROM drive.
- ② Double click on the "My Computer" icon.
- ③ Double click on the "CD-ROM" drive.
- ④ Double click on the "manuals" folder.
- ⑤ Double click on the "acrobat" folder.
- ⑥ Double click on the "windows" folder.
- ⑦ Double click on the desired installation program and follow the instructions on the screen.

For Macintosh:

- ① Insert the CD-ROM in the CD-ROM drive.
- ② Double click on the "CD-ROM" icon.
- ③ Double click on the "manuals" folder.
- ④ Double click on the "acrobat" folder.
- ⑤ Double click on the "mac" folder.
- ⑥ Double click on the desired installation program and follow the instructions on the screen.

For other operating systems:

Please download Acrobat Reader from the Internet (<http://www.adobe.com>).

For other languages:

If you prefer using Acrobat Reader for languages other than those included in the CD-ROM, please download the appropriate version from the Internet.

Accessing the PDF Manuals

For Windows:

- ① Insert the CD-ROM in the CD-ROM drive.
- ② Double click on the "My Computer" icon.
- ③ Double click on the "CD-ROM" drive.
- ④ Double click on the "manuals" folder.
- ⑤ Double click on the "xg-nv6xu" folder.
- ⑥ Double click on the language (name of the folder) that you want to view.
- ⑦ Double click on the "nv6" pdf file to access the projector manuals.
Double click on the "saps" pdf file to access the Sharp Advanced Presentation Software manual.
- ⑧ Double click on the pdf file.

For Macintosh:

- ① Insert the CD-ROM in the CD-ROM drive.
- ② Double click on the "CD-ROM" icon.
- ③ Double click on the "manuals" folder.
- ④ Double click on the "xg-nv6xu" folder.
- ⑤ Double click on the language (name of the folder) that you want to view.
- ⑥ Double click on the "nv6" pdf file to access the projector manuals.
Double click on the "saps" pdf file to access the Sharp Advanced Presentation Software manual.
- ⑦ Double click on the pdf file.

NOTE

- If the desired pdf file cannot be opened by double clicking the mouse, please start Acrobat Reader first, then specify the desired file using the "File", "Open" menu.
- See the "readme.txt" file on the CD-ROM for important information on the CD-ROM not included in this operation manual.



For SHARP Assistance (U.S.A. only)

If you encounter any problems during setup or operation of this projector, first refer to the "Troubleshooting" section on page 49. If this operation manual does not answer your question, please call toll free 1-800-BE-SHARP (1-800-237-4277) for further assistance. Or, send us an e-mail at lcdsupport@sharplcd.com. Our World Wide Web address is <http://www.sharp-usa.com/>.



Part Names

Numbers next to the part names refer to the main pages in this manual where the topic is explained.

Projector

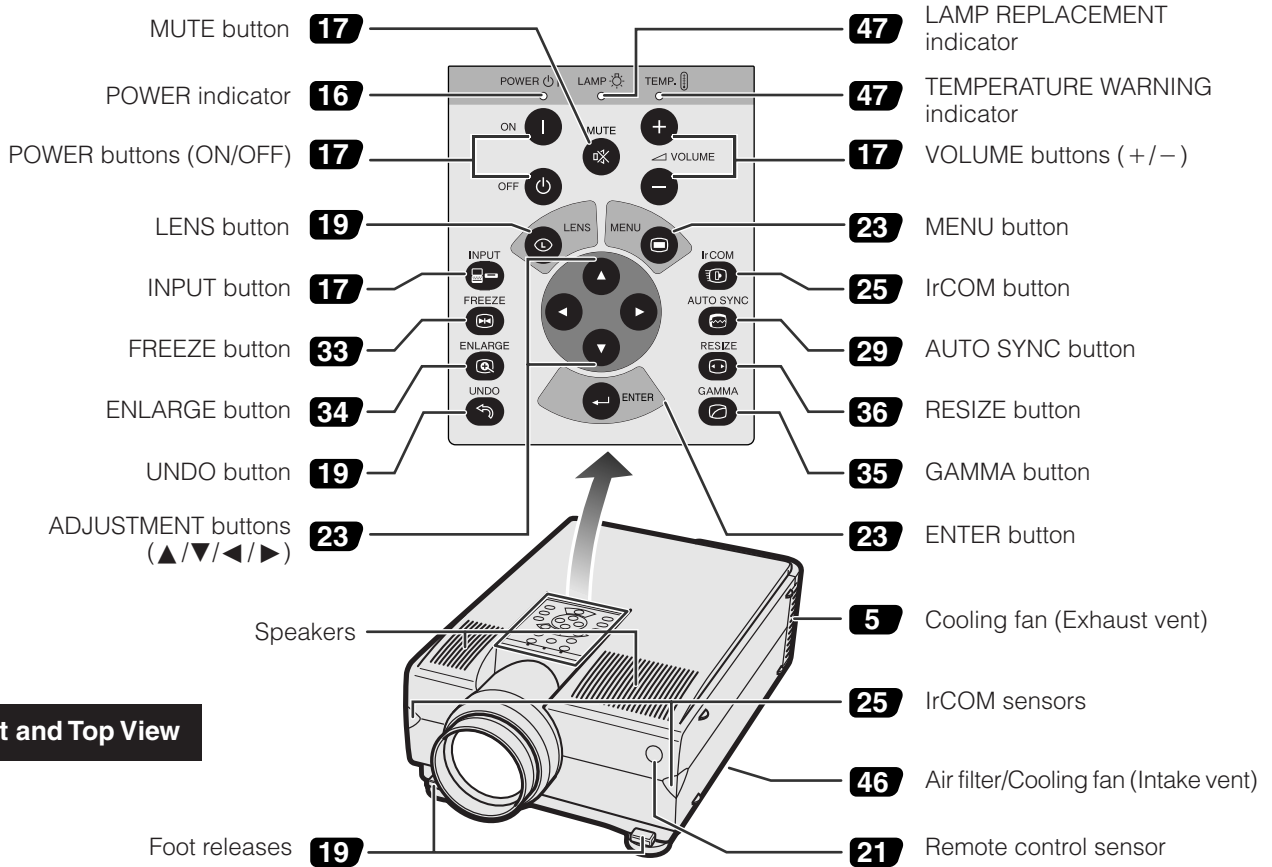

Front and Top View

Side and Rear View

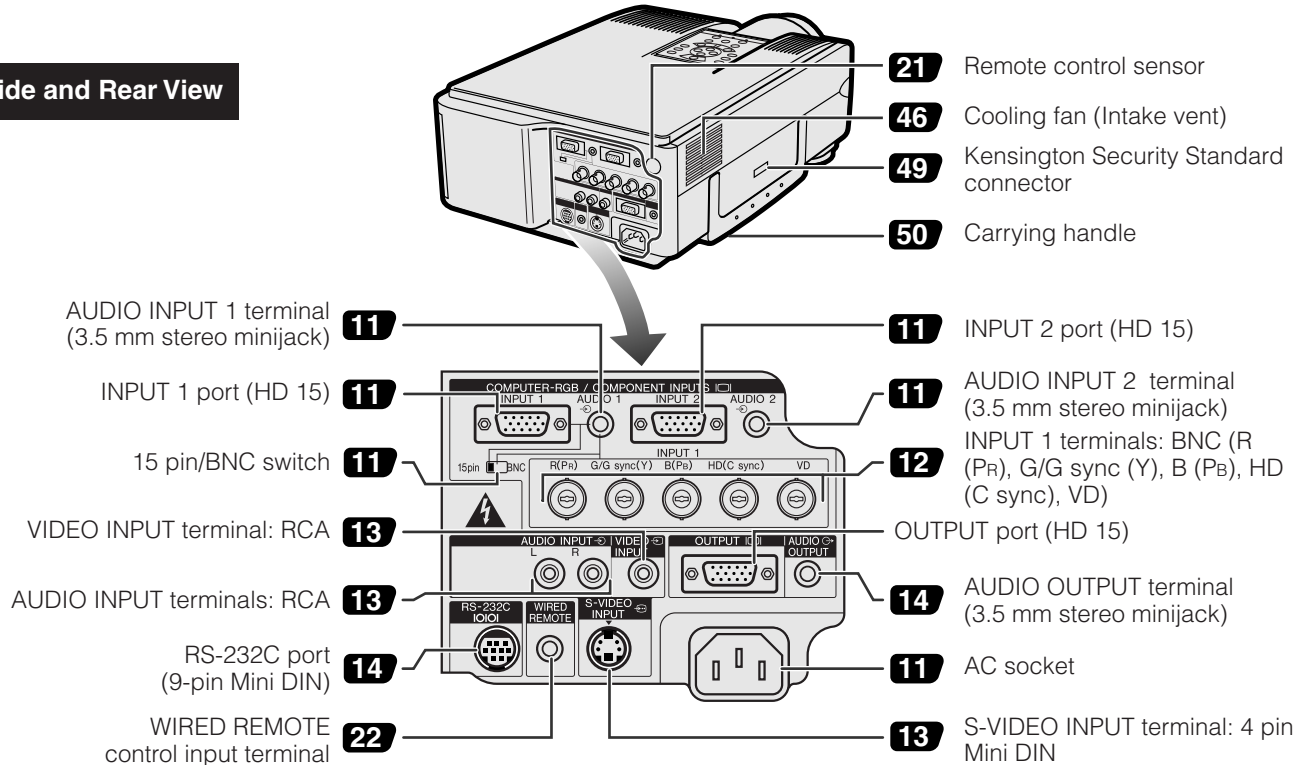

Important Information





Remote Control

Front View

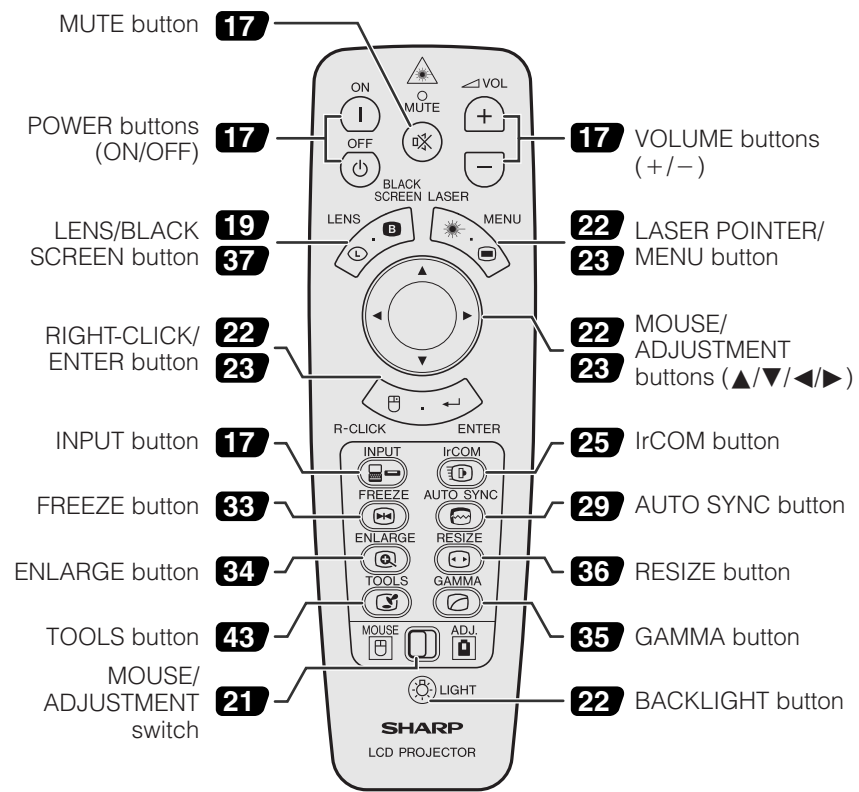

Top View

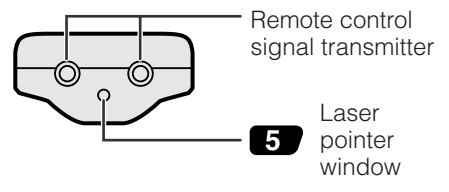

Rear View

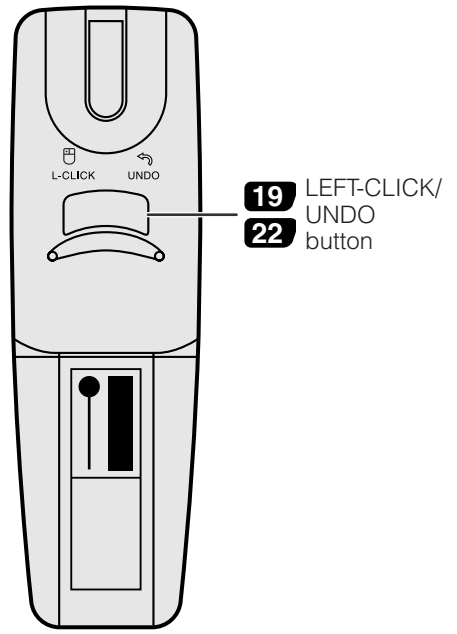

Bottom View

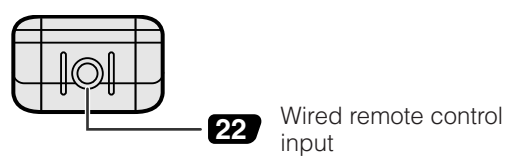

Inserting the batteries

<p>1 Press in and downward on the arrow to remove the battery cover.</p>	<p>2 Insert two AA size batteries for the remote control, making sure their polarities match the + and - marks inside the battery compartment.</p>	<p>3 Insert the side tabs of the battery cover into their slots and press the cover in until it is properly seated.</p>
<p>Battery cover</p>	<p>Battery compartment</p>	<p>Battery cover</p>



Setup & Connections

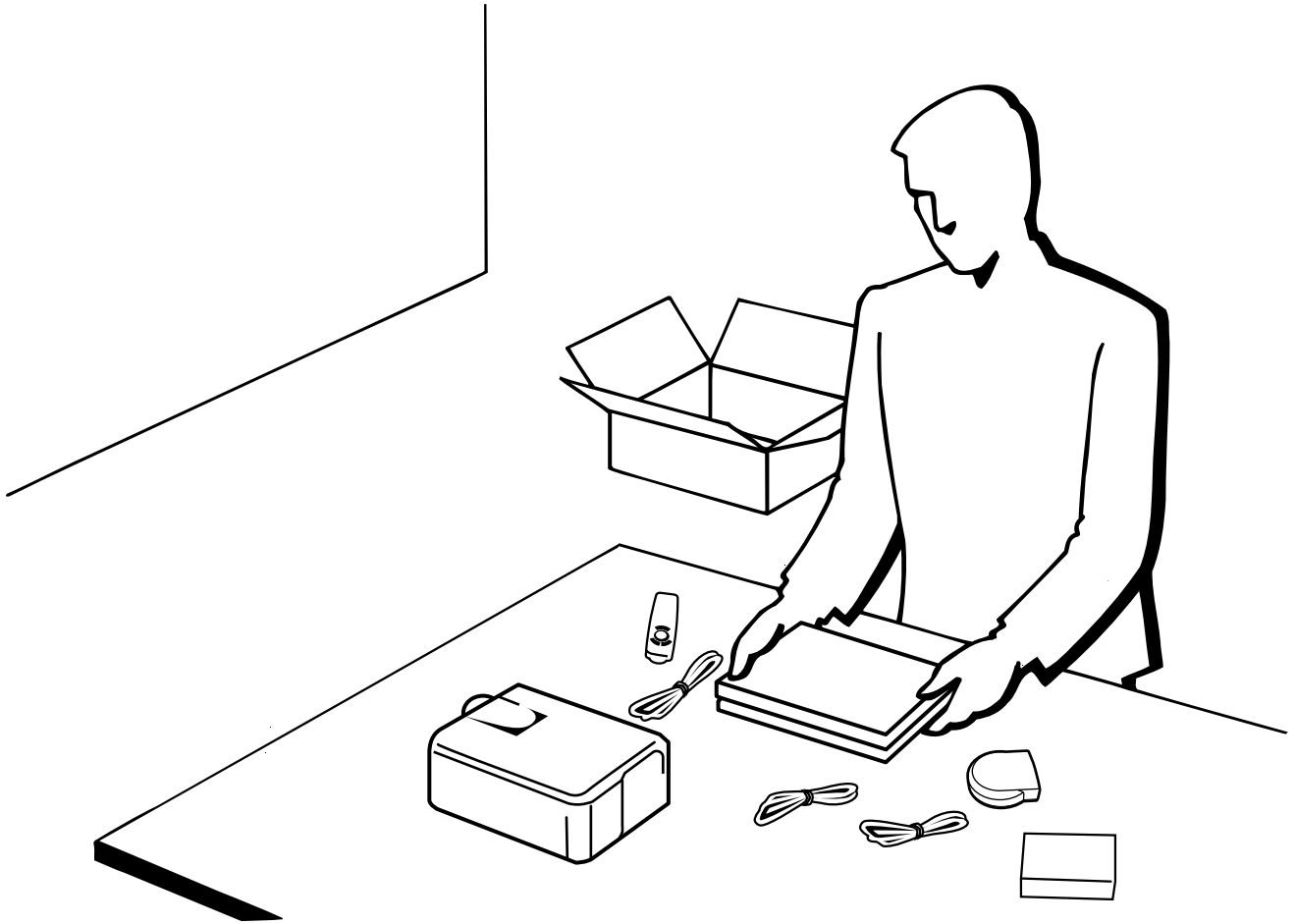

Setting up the Projector

1. Supplied Accessories

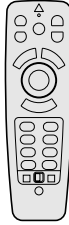

Remote control
RRMCG1518CESA



Two AA size batteries

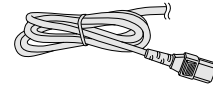

Power cord
QACCU5013CEZZ

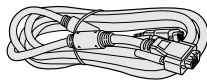

Computer cable
QCNW-5304CEZZ

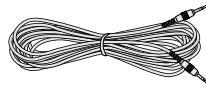

Computer audio cable
QCNW-4870CEZZ



Three BNC-RCA adaptors
QPLGJ0107GEZZ

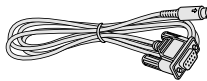

Mouse control
serial cable
QCNW-5112CEZZ

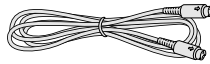

Mouse control
cable for IBM PS/2
QCNW-5113CEZZ

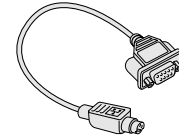

Mouse control cable
for Mac
QCNW-5114CEZZ

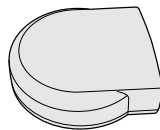

Remote mouse receiver
RUNTK0661CEZZ

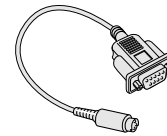

DIN-D-sub RS-232C cable
QCNW-5288CEZZ

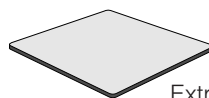
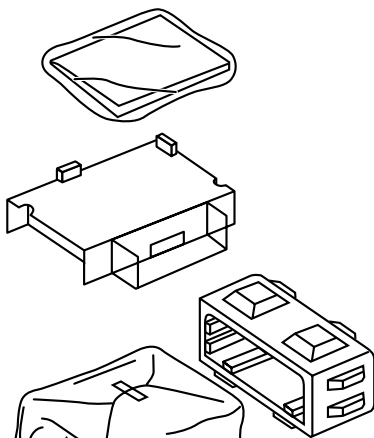

Extra air filter
PFILD0080CEZZ

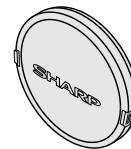

Lens cap
PCAPH1056CESA

CD-ROM

Sharp Advanced Presentation
Software operation manual

LCD projector operation manual

Sharp Advanced Presentation
Software quick reference

LCD projector quick reference

IrDA driver installation
instruction sheet

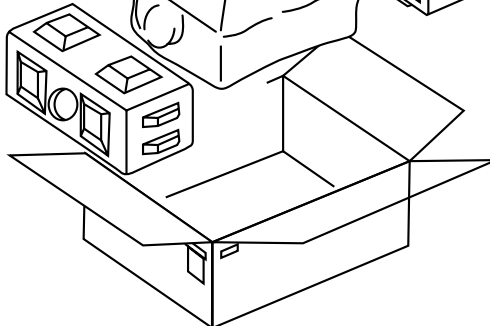

2. Connecting the Projector

Connecting the Power Cord

Plug the supplied power cord into the AC socket on the back of the projector.

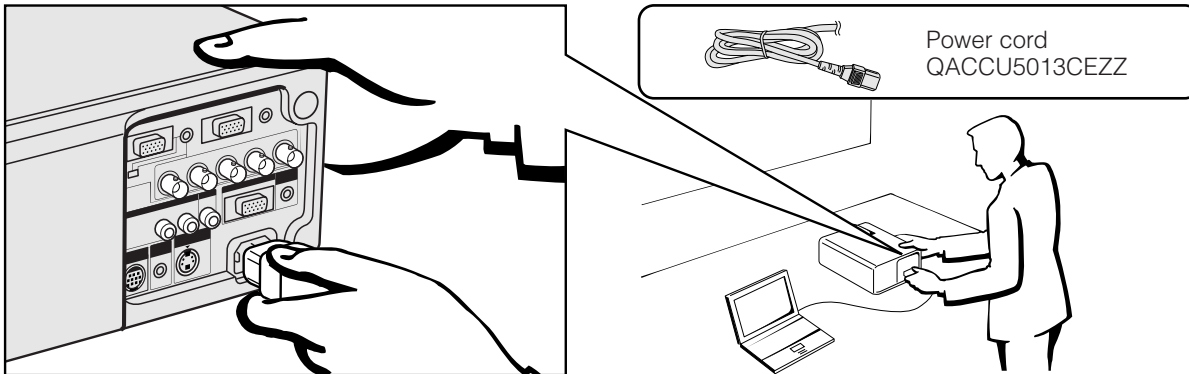

Connecting the Projector to a Computer

You can connect your projector to a computer for projection of full color computer images.

Connecting an IBM-PC or a Macintosh computer using the standard 15 pin Input

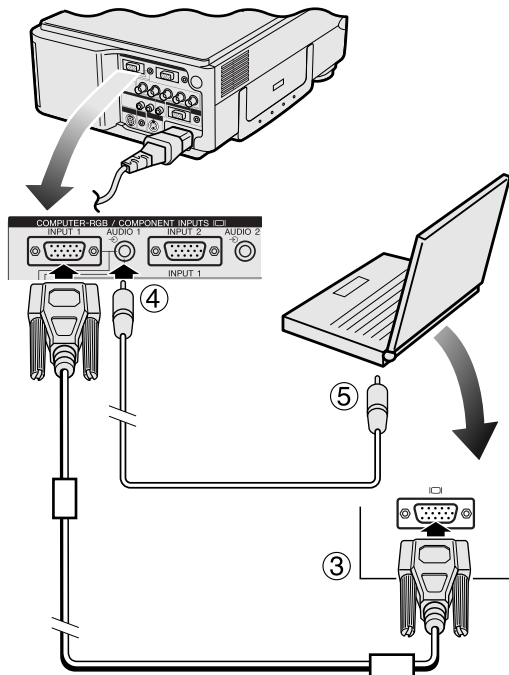
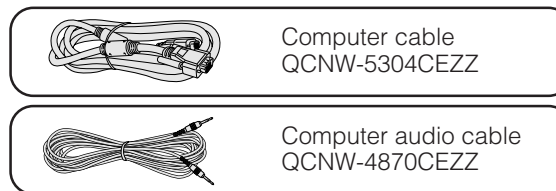
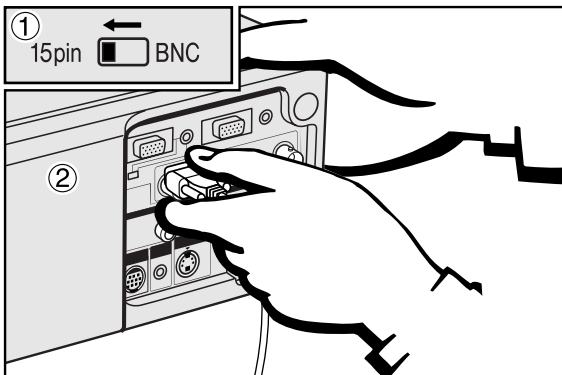

- ① To use the Standard 15-pin connector, slide the 15 pin/BNC switch on the rear terminals to the 15 pin position.
- ② Connect one end of the supplied computer cable to the COMPUTER-RGB INPUT 1 or 2 port on the projector.
- ③ Connect the other end to the Monitor output port on the computer. Secure the connectors by tightening the thumb screws.
- ④ To use the built-in audio system, connect one end of the supplied computer audio cable to the AUDIO INPUT 1 or 2 terminal on the projector.
- ⑤ Connect the other end to the Audio output terminal on the computer.

CAUTION

- Before connecting, be sure to turn both the projector and the computer off. After making all connections, turn the projector on first. The computer should always be turned on last.

NOTE

- Please read the computer's operation manual carefully.
- Refer to pages 55 and 56 "Input Signals (Recommended Timing)" for a list of computer signals compatible with the projector. Use with computer signals other than those listed may cause some of the functions not to work.

When connecting this projector to a computer, select "Computer/RGB" for "Signal Type" on the GUI menu. (See page 40.)

NOTE

- A Macintosh adaptor may be required for use with some Macintosh computers. Contact your nearest Authorized Sharp Industrial LCD Products Dealer or Service Center.

- This projector uses a 5 BNC computer input to prevent deterioration of image quality.
- Connect the R (Pr), G/G sync (Y), B (Pb), HD (C sync) and VD cables to the correct input terminals on the projector and an RGB switcher (sold separately) connected to the computer, or connect a 5 BNC cable (sold separately) directly from the input terminals on the projector to the computer.

Connecting to an external RGB switcher or other compatible computers using the BNC Input (Typically used in larger installations)

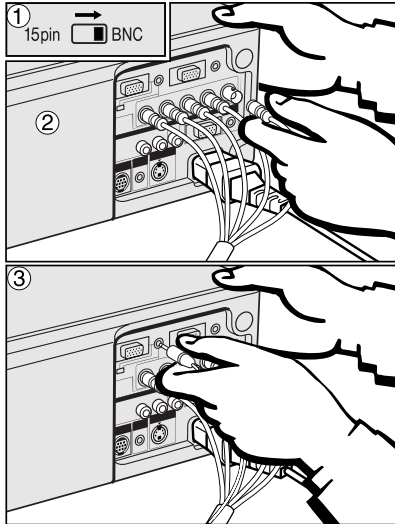

Computer audio cable
QCNW-4870CEZZ

- ① To use the 5 BNC connector, slide the 15 pin/BNC switch on the rear terminals to the BNC position.
Connect each BNC connector to the corresponding BNC INPUT 1 terminals on the projector.
- ② Connect the other end of the 5 BNC cable to the corresponding BNC terminals on the external RGB switcher.
- ③ To use the built-in audio system, connect one end of the supplied computer audio cable to the AUDIO INPUT 1 or 2 terminal on the projector.
- ④ Connect the other end to the Audio output terminal on the computer or external audio system.

NOTE

- A 3.5 mm minijack to RCA audio cable adaptor may be necessary.

When connecting the projector to a compatible computer other than an IBM-PC (VGA/SVGA/XGA/SXGA/UXGA) or Macintosh (i.e. Workstation), a separate cable may be needed. Please contact your dealer for more information.

When connecting this projector to a computer, select “Computer/RGB” for “Signal Type” on the GUI menu. (See page 40.)

NOTE

- Connecting computers other than the recommended types may result in damage to the projector, the computer, or both.
- AUDIO INPUT 1 or 2 accepts INPUT 1 or 2 port input.

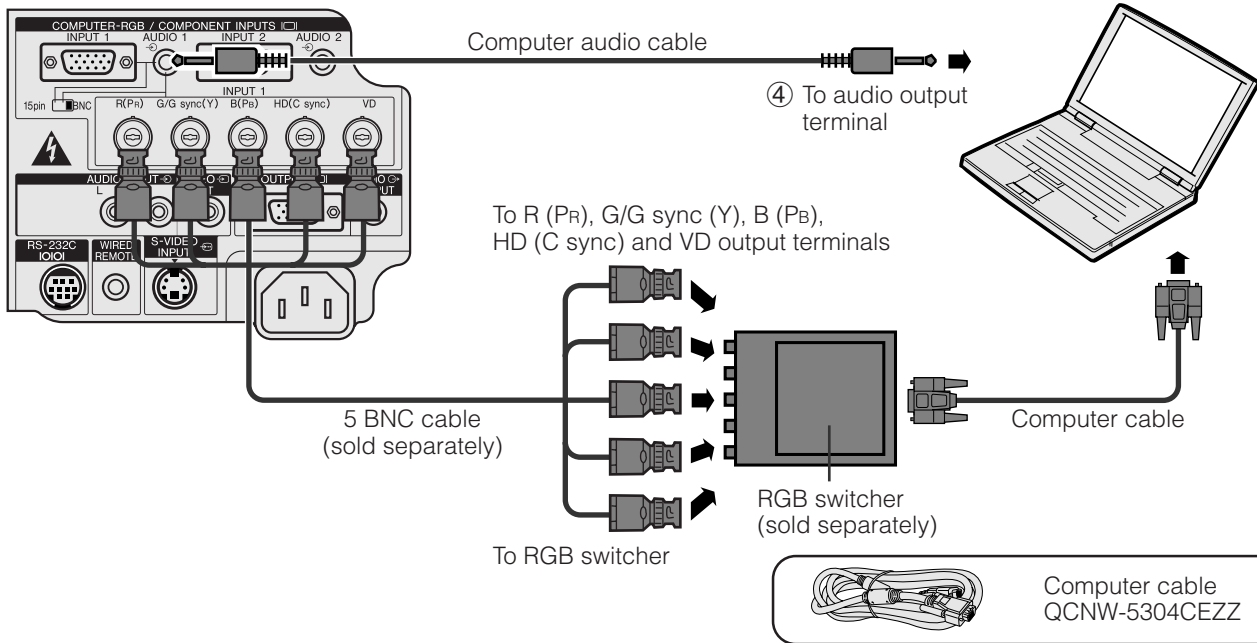

Computer cable
QCNW-5304CEZZ

“Plug and Play” function (when connecting to a 15 pin terminal)

- This projector is compatible with VESA-standard DDC 1/DDC 2B. The projector and a VESA DDC compatible computer will communicate their setting requirements, allowing for quick and easy setup.
- Before using the “Plug and Play” function, be sure to turn on the projector first and the connected computer last.

NOTE

- The DDC, Plug and Play function of this projector operates only when used in conjunction with a VESA DDC compatible computer.

Connecting the Projector to Video Equipment

You can connect your projector to a VCR, laser disc player, DVD player, DTV decoder and other audiovisual equipment.

CAUTION

- Always turn off the projector while connecting to video equipment, in order to protect both the projector and the equipment being connected.

Connecting a VCR, laser disc player and other audiovisual equipment using the standard video Input

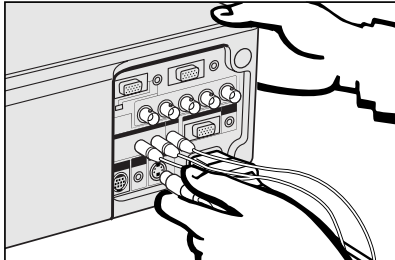

- Connect the yellow RCA connectors to the corresponding yellow VIDEO INPUT terminal on the projector and the Video output terminal on the video source.
- To use the built-in audio system, connect the red and white RCA connectors to the corresponding red and white AUDIO INPUT terminals on the projector and the Audio output terminals on the video source.

The S-VIDEO INPUT terminal uses a video signal system in which the picture is separated into a color and a luminance signal to realize a higher-quality image.

NOTE

- For higher quality video, you may use the S-VIDEO INPUT terminal on the projector. S-video cable is sold separately.
- If your video equipment does not have an S-video output terminal, use the Composite video output terminal.

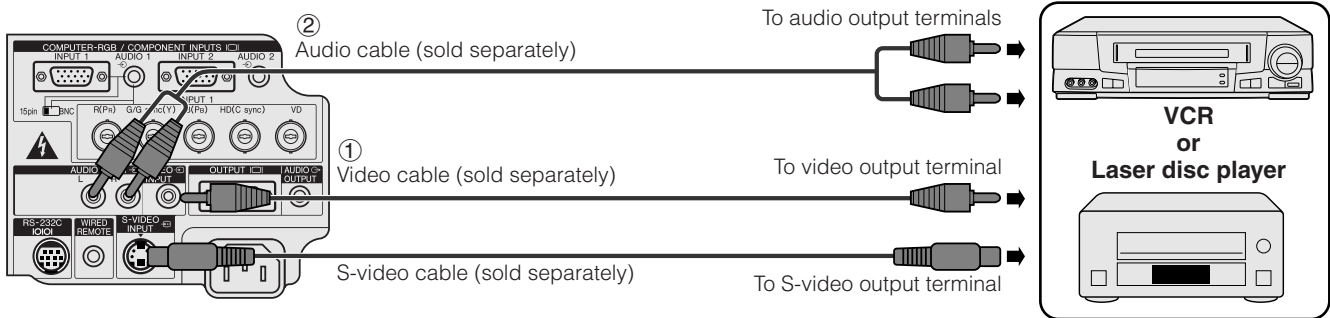

Connecting a DVD player, DTV decoder and other component video equipment using the 5 BNC Input

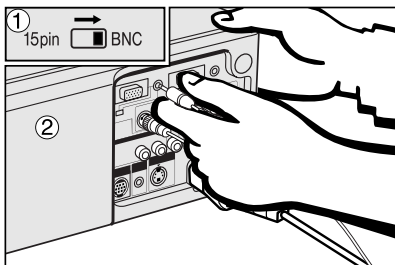

- To use the 5 BNC connector, slide the 15 pin/BNC switch on the rear terminals to the BNC position. Connect each BNC connector to the corresponding BNC INPUT 1 terminals on the projector.

NOTE

- BNC-RCA adaptors are included for use with RCA type cables and sources.
- Connect the other end of the cable to the corresponding terminals of a DVD player or DTV decoder.
 - To use the built-in audio system, connect one end of the supplied computer audio cable to AUDIO INPUT 1 or 2 terminal on the projector. Connect the other end to the Audio output terminal on the computer.

NOTE

- A 3.5 mm minijack to RCA audio cable adaptor may be necessary.

When connecting this projector to a DVD player or a DTV decoder, select "Component" for "Signal Type" on the GUI menu. (See page 40.)

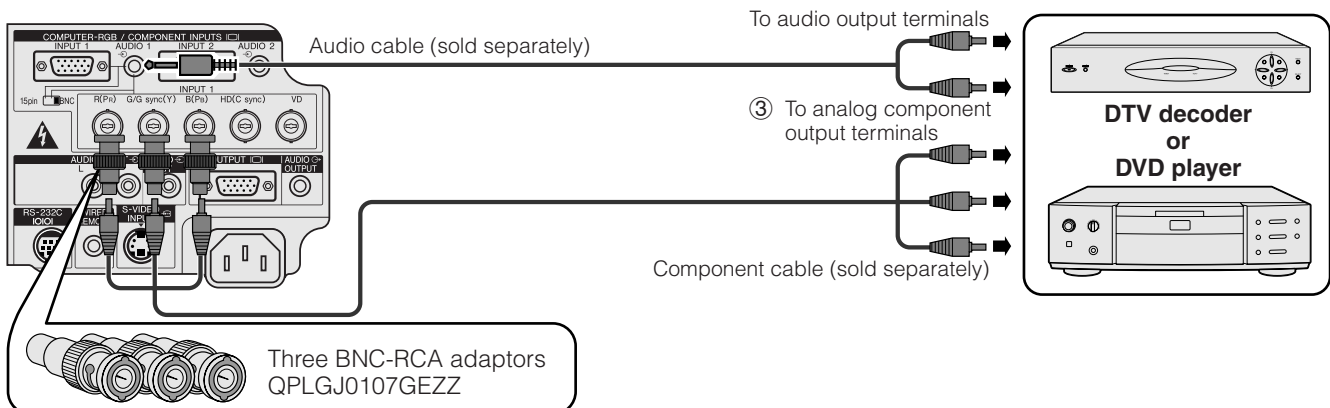

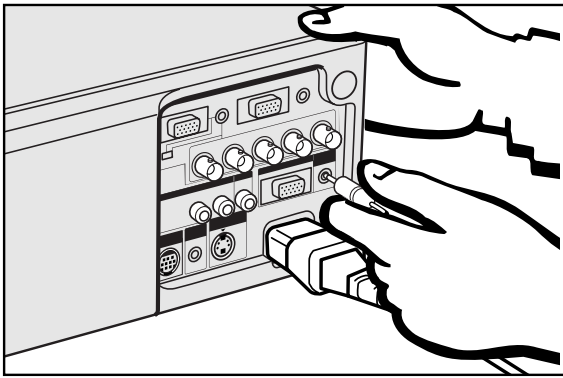

Connecting an amplifier and other audio components

CAUTION

- Always turn off the projector while connecting to audio components, in order to protect both the projector and the components being connected.

NOTE

- By using external audio components, the volume can be amplified for better sound.

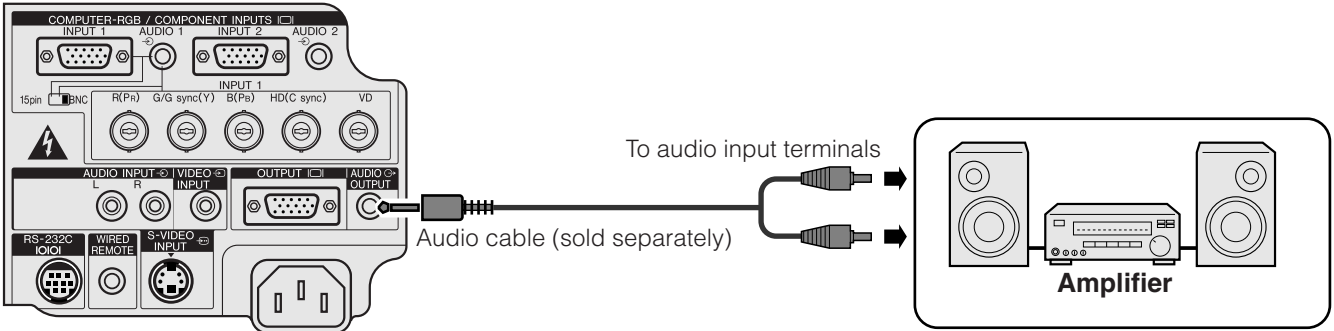

Connecting RS-232C Port

When the RS-232C port on the projector is connected to a computer with an RS-232C cable (cross type, sold separately), the computer can be used to control the projector and check the status of the projector. See pages 52 and 53 for details.

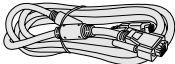

Computer cable
QCNW-5304CEZZ

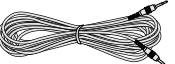

Computer audio cable
QCNW-4870CEZZ

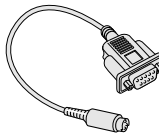

DIN-D-sub RS-232C
cable
QCNW-5288CEZZ

- 1 Connect the supplied DIN-D-sub RS-232C cable to the RS-232C port on the projector.
- 2 Connect a RS-232C cable (sold separately) to the other end of DIN-D-sub RS-232C cable and to the serial port on the computer.

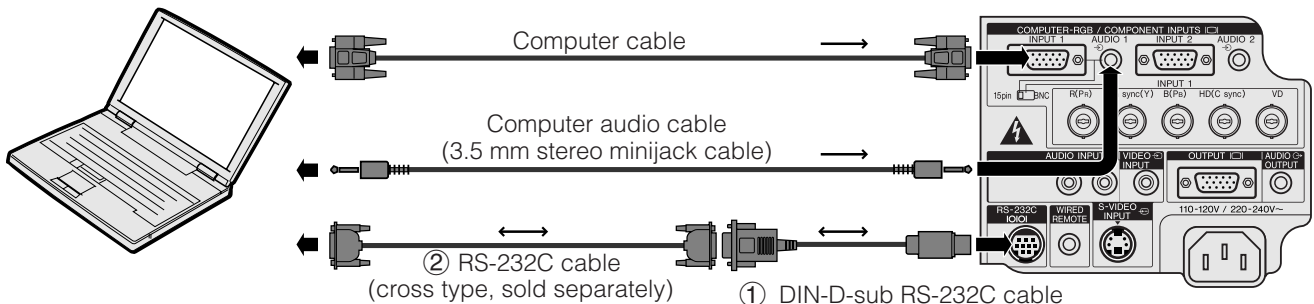

CAUTION

- Do not connect or remove RS-232C cable to or from the computer while it is on. This may damage your computer.

NOTE

- The wireless mouse or RS-232C function may not operate if your computer port is not correctly set up. Please refer to the operation manual of the computer for details on setting up/installing the correct mouse driver.
- The arrows (→, ↔) indicate the direction of the signals.
- A Macintosh adaptor may be required for use with some Macintosh computers. Contact your nearest Authorized Sharp Industrial LCD Products Dealer or Service Center.

Connecting the Remote Mouse Receiver

- You can use the remote control as a remote mouse.
- When the RS-232C port on the projector is connected to a computer with an RS-232C cable (cross type, sold separately), the computer can be used to control the projector and check the status of the projector. See pages 52 and 53 for details.

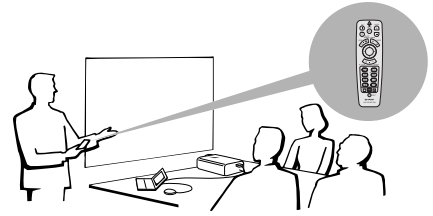

IBM or IBM compatible PC

- 1 Connect one end of the supplied mouse control cable to the corresponding terminal on the PC.
- 2 Connect the other end to the remote mouse receiver.

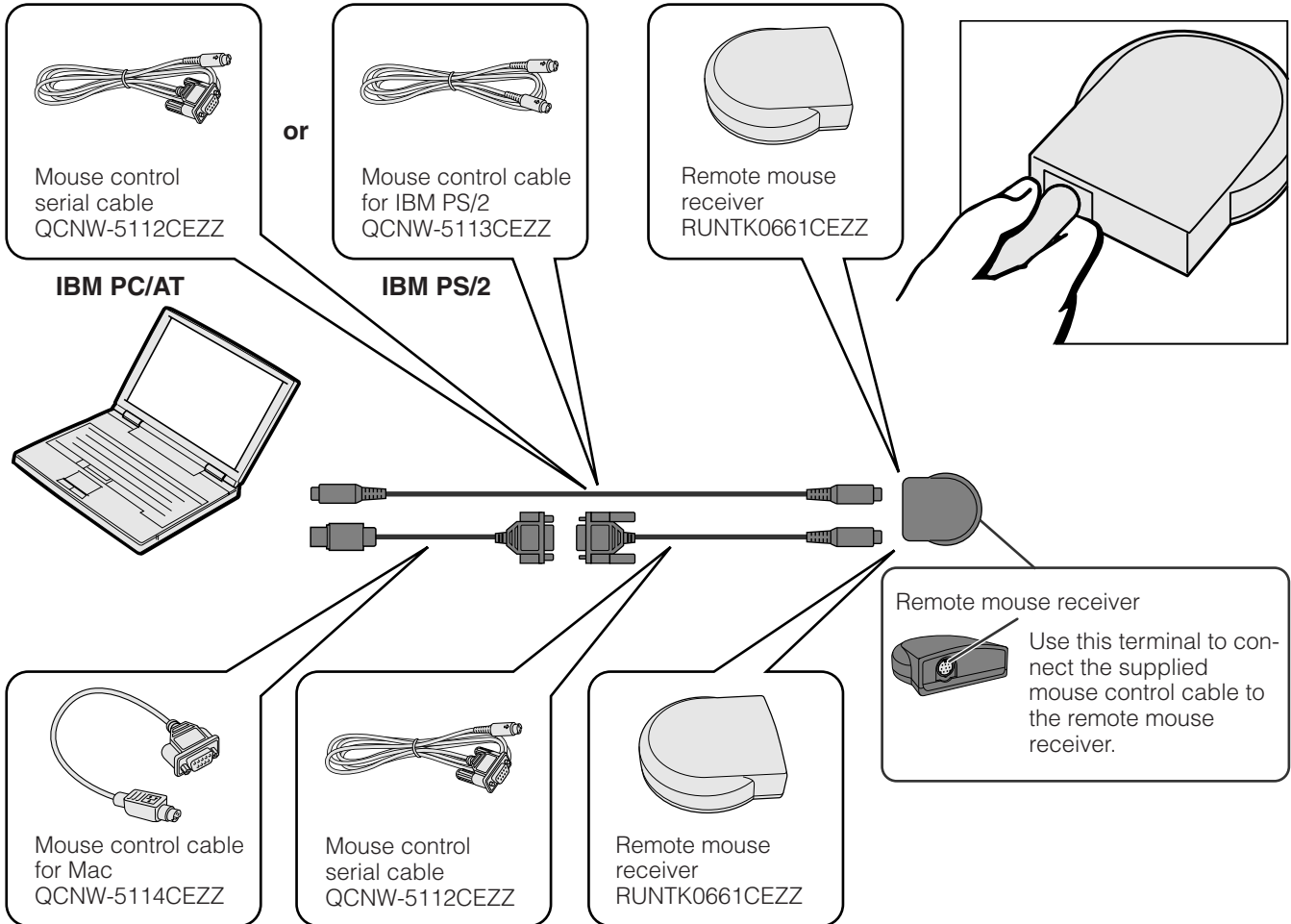

Macintosh

- 1 Connect the mouse control serial cable to the remote mouse receiver.
- 2 Connect the mouse control cable for Mac to the Mac ADB port on the Mac.
- 3 Connect the other end of the mouse control cable for Mac to the mouse control serial cable.

CAUTION

- Do not connect or remove the mouse control cables to or from the computer while it is on. This may damage your computer.

NOTE

- The wireless mouse functions can operate computers compatible with IBM PS/2, serial (RS-232C) or Apple ADB type mouse systems.

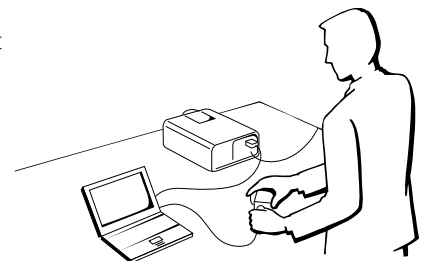



Operation

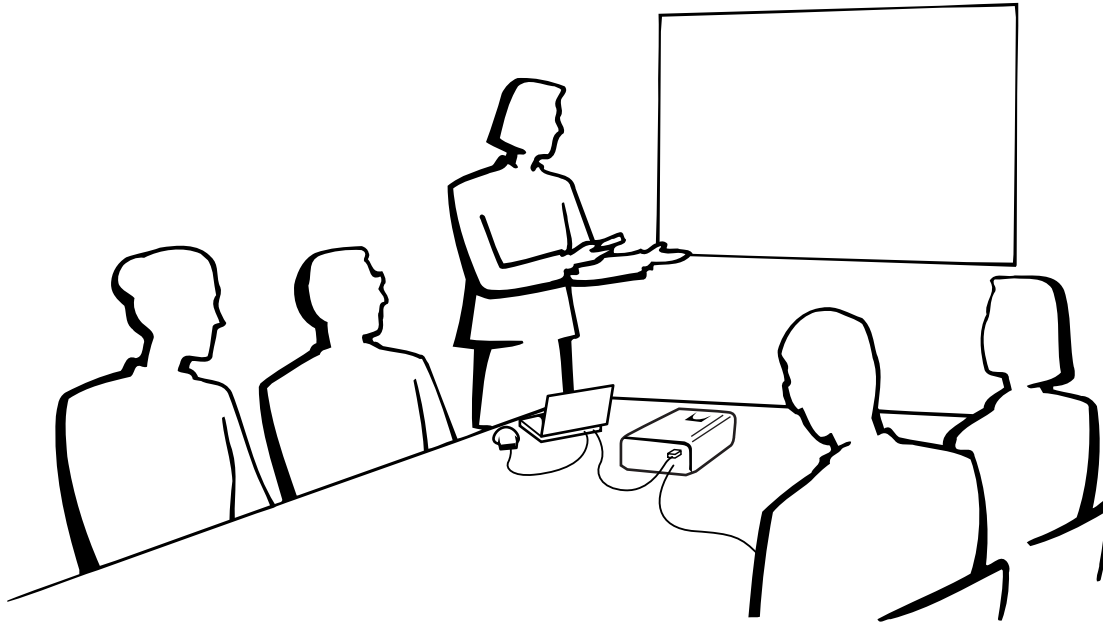

Basic Operations

1. Turning on/off the Power

1

Make the necessary connections before proceeding.
Connect the power cord to a wall outlet.

The POWER indicator lights up red and the projector enters standby mode.

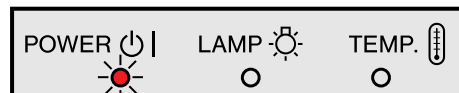

NOTE

- If the bottom filter cover is not securely installed, the POWER indicator flashes.

2

ON
1

Press **Power ON**.

NOTE

- The flashing green LAMP REPLACEMENT indicator shows that the lamp is warming up. Wait until the indicator stops flashing before operating the projector.
- If the power is turned off and then immediately turned on again, it may take a short while before the lamp turns on.
- After the projector is unpacked and turned on for the first time, a slight odor may be emitted from the exhaust vent. This odor will soon disappear with use.

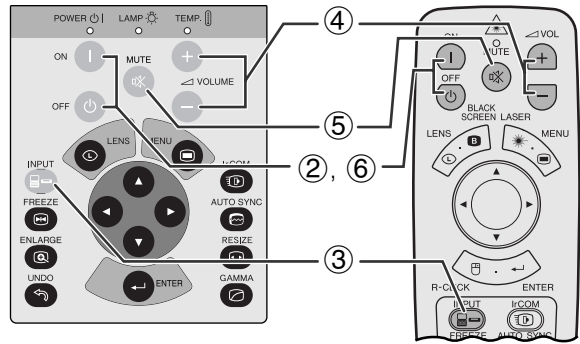

When the power is on, the LAMP REPLACEMENT indicator lights indicating the status of the lamp.

- Green:** Lamp is ready.
- Flashing green:** Warming up.
- Red:** Change the lamp.

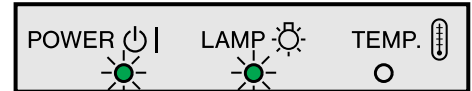

3

INPUT

Press **INPUT** to select the desired input mode. Press **INPUT** again to change the mode.

EXAMPLE

INPUT 1 Mode



INPUT 2 Mode



VIDEO Mode



NOTE

- When no signal is being received, "NO SIGNAL" will be displayed. When a signal that the projector is not preset to receive is being received, "NOT REG." will be displayed.

4

VOL
+
-

Press **VOLUME +/-** to adjust the volume.

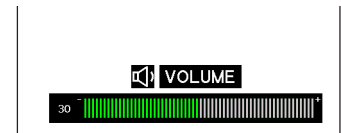

5

MUTE
MUTE icon

Press **MUTE** to temporarily turn off the sound. Press **MUTE** again to turn the sound back on.



6

OFF
Power OFF icon

Press **POWER OFF**. Press **POWER OFF** again while the message is displayed.



NOTE

- If you accidentally pressed **POWER OFF** and do not want to turn off the power, wait until the power off screen disappears.
- When **POWER OFF** is pressed twice, the POWER indicator will light up red and the cooling fan will run for about 90 seconds. The projector will then enter standby mode.
- Wait until the cooling fan stops before disconnecting the power cord.
- The power can be turned on again by pressing **POWER ON**. When the power is turned on, the POWER indicator and the LAMP REPLACEMENT indicator light green.
- The POWER indicator flashes if the bottom filter cover is not securely installed.

2. Setting up the Screen

Position the projector perpendicular to the screen with all feet flat and level to achieve an optimal image. Move the projector forward or backward if the edges of the image are distorted.

NOTE

- The projector lens should be centered in the middle of the screen. If the lens center is not perpendicular to the screen, the image will be distorted, making viewing difficult.
- Position the screen so that it is not in direct sunlight or room light. Light falling directly onto the screen washes out colors, making viewing difficult. Close the curtains and dim the lights when setting up the screen in a sunny or bright room.
- A polarizing screen cannot be used with this projector.

Standard Setup (Front Projection)

Place the projector at the required distance from the screen according to the desired picture size (see the table below).

NOTE

- Optional wide and telephoto lenses from Sharp are available for specialized application. Please see your local Sharp Industrial LCD Products Dealer for details on the AN-T6EZ and AN-W6EZ lenses.

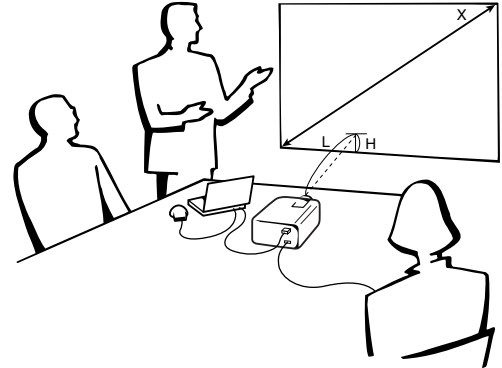

NORMAL Mode (4:3)

Picture size			Projection distance		Distance from the lens center to the bottom of the image (H)
Diag.	Width	Height	Maximum	Minimum	
300"	240"	180"	47' (14.3 m)	36' 2" (11.0 m)	9" (22.9 cm)
200"	160"	120"	32' 2" (9.8 m)	24' 3" (7.4 m)	6" (15.2 cm)
150"	120"	90"	23' 6" (7.2 m)	18' 4" (5.6 m)	4 1/2" (11.4 cm)
100"	80"	60"	15' 11" (4.9 m)	12' (3.7 m)	3" (7.6 cm)
84"	67"	50"	13' 2" (4.0 m)	10' 1" (3.1 m)	2 33/64" (6.4 cm)
72"	58"	43"	11' 1" (3.4 m)	8' 6" (2.6 m)	2 5/32" (5.5 cm)
60"	48"	36"	9' 6" (2.9 m)	7' 3" (2.2 m)	1 51/64" (4.6 cm)
40"	32"	24"	6' 1" (1.9 m)	4' 7" (1.4 m)	1 13/64" (3.1 cm)

The formula for picture size and projection distance

$$y_1 = (0.0482x - 0.0226) \times 3.28$$

$$y_2 = (0.037x - 0.041) \times 3.28$$

$$y_3 = 0.03x$$

x : Picture size (diag.) (inches)

y_1 : Maximum projection distance (feet)

y_2 : Minimum projection distance (feet)

y_3 : Distance from the lens center to the bottom of the image (H) (inches)

NOTE

- There is an error of $\pm 3\%$ in the formula above.

WIDE Mode (16:9)

Picture size			Projection distance		Distance from the lens center to the bottom of the image (H)
Diag.	Width	Height	Maximum	Minimum	
300"	261"	147"	51' 3" (15.6 m)	39' 5" (12.0 m)	- 14 45/64" (- 37.4 cm)
200"	174"	98"	34' 5" (10.5 m)	26' 5" (8.1 m)	- 9 13/16" (- 24.9 cm)
150"	131"	74"	25' 11" (7.9 m)	19' 11" (6.1 m)	- 7 11/32" (- 18.7 cm)
133"	116"	65"	23' (7.0 m)	17' 7" (5.4 m)	- 6 33/64" (- 16.6 cm)
106"	92"	52"	18' 3" (5.6 m)	14' (4.3 m)	- 5 13/64" (- 13.2 cm)
100"	87"	49"	17' (5.2 m)	13' 1" (4.0 m)	- 4 29/32" (- 12.5 cm)
92"	80"	45"	15' 10" (4.8 m)	12' 1" (3.7 m)	- 4 33/64" (- 11.5 cm)
84"	73"	41"	14' 1" (4.3 m)	10' 10" (3.3 m)	- 4 1/8" (- 10.5 cm)
72"	63"	35"	12' (3.7 m)	9' 3" (2.8 m)	- 3 17/32" (- 9.0 cm)
60"	52"	29"	10' 2" (3.1 m)	7' 10" (2.4 m)	- 2 15/16" (- 7.5 cm)
40"	35"	20"	6' 6" (2.0 m)	5' (1.5 m)	- 1 61/64" (- 5.0 cm)

The formula for picture size and projection distance

$$y_1 = (0.0525x - 0.0546) \times 3.28$$

$$y_2 = (0.0404x - 0.0397) \times 3.28$$

$$y_3 = -0.049x$$

x : Picture size (diag.) (inches)

y_1 : Maximum projection distance (feet)

y_2 : Minimum projection distance (feet)

y_3 : Distance from the lens center to the bottom of the image (H) (inches)

NOTE

- There is an error of $\pm 3\%$ in the formula above.
- Values with a minus (-) sign indicate the distance of the lens center below the bottom of the screen.

Using the Adjustment Feet

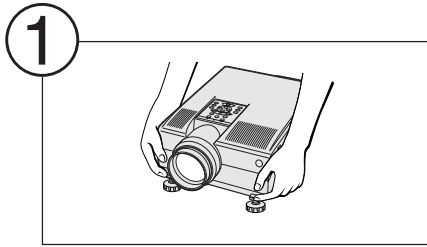

Press foot releases.

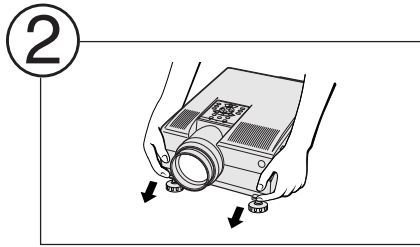

Adjust height of projector and remove hands from foot releases.

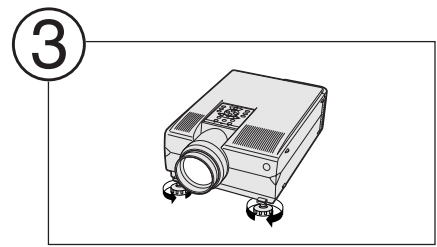

Rotate feet to make minor changes.

NOTE

- The projector is adjustable up to approximately 5° from the standard position.
- When the height of the projector is adjusted, the image may become distorted (keystoned), depending on the relative positions of the projector and the screen.

CAUTION

- Do not press the foot releases when the adjustment feet are extended without firmly holding the projector.
- Do not hold the lens when lifting or lowering the projector.
- When lowering the projector, be careful not to get your fingers caught in the area between the adjustment feet and the projector.

Digital Lens Adjustment

1

LENS

Press **LENS** to select mode. Each time **LENS** is pressed, the screen changes in the following order.

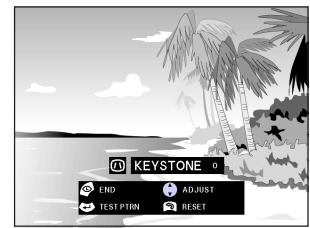
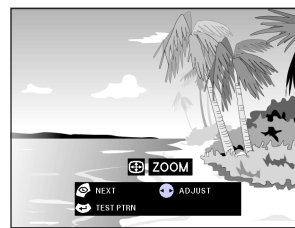
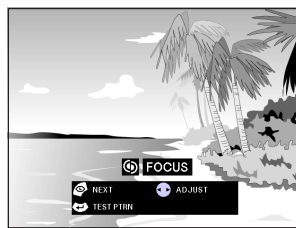
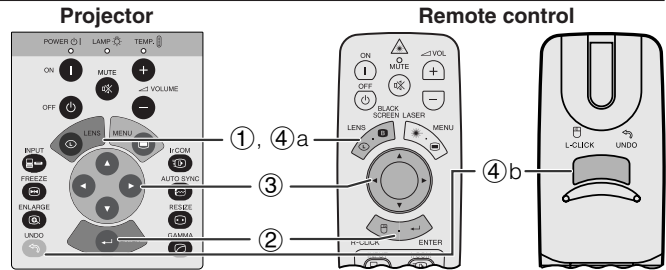

2

ENTER

Press **ENTER** to display test pattern.

3



Press **▲/▼/◀/▶** to make adjustments.

4

LENS

a. Press **LENS** until normal screen appears.

UNDO

b. To reset the **KEYSTONE** setting, press **UNDO**.

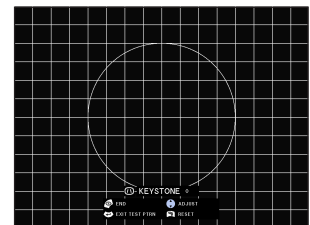

NOTE

- Straight lines and the edges of the displayed image may appear jagged, when adjusting the **KEYSTONE** setting.
- Do not touch the lens when adjusting the focus or zoom.



Reversed Image Setup

Rear projection

- Place a translucent screen between the projector and the audience.
- Use the projector's menu system to reverse the projected image. (See page 42 for use of this function.)

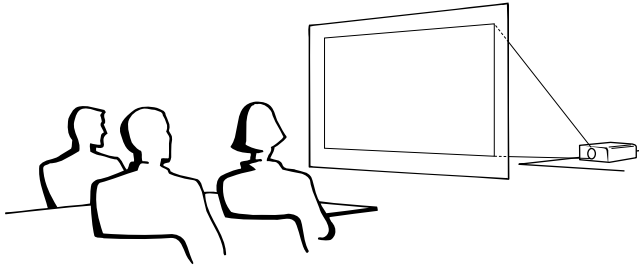

Projection using a mirror

- Place a mirror (normal flat type) in front of the lens.
- Use the projector's menu system to reverse the projected image. (See page 42 for use of this function.)
- The image reflected from the mirror is projected onto the screen.

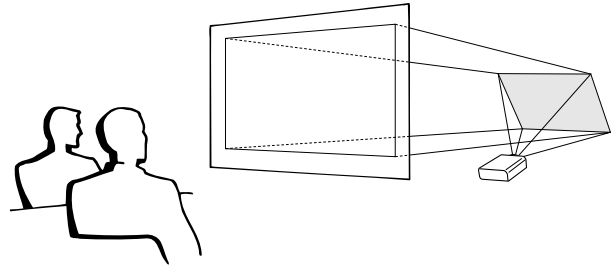

NOTE

- Optimal image quality is produced with the projector positioned perpendicular to the screen with all feet flat and level.

CAUTION

- When using a mirror, be sure to carefully position both the projector and the mirror so the light does not shine into the eyes of the audience.

Ceiling-mount Setup

- It is recommended that you use the optional Sharp ceiling-mount bracket for this installation.
- Before mounting the projector, contact your nearest Authorized Sharp Industrial LCD Products Dealer or Service Center to obtain the recommended ceiling-mount bracket (sold separately). (AN-XGCM60 ceiling-mount bracket, AN-EP101AP extension tube for AN-XGCM60.)
- When the projector is in the inverted position, use the upper edge of the screen as the base line.
- Use the projector's menu system to select the appropriate projection mode. (See page 42 for use of this function.)

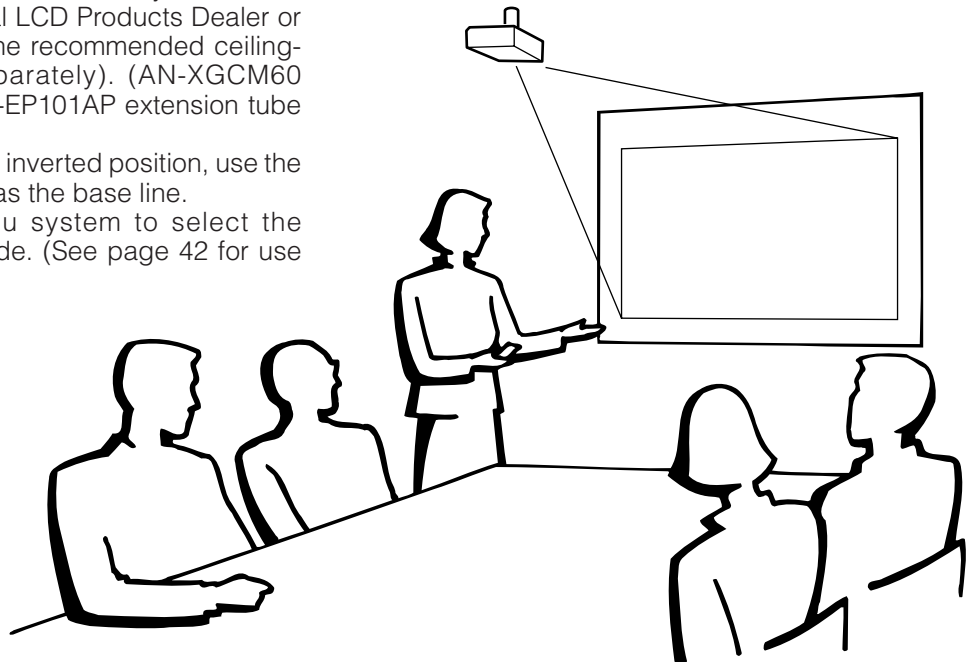

3. Operating the Wireless Mouse from the Remote Control

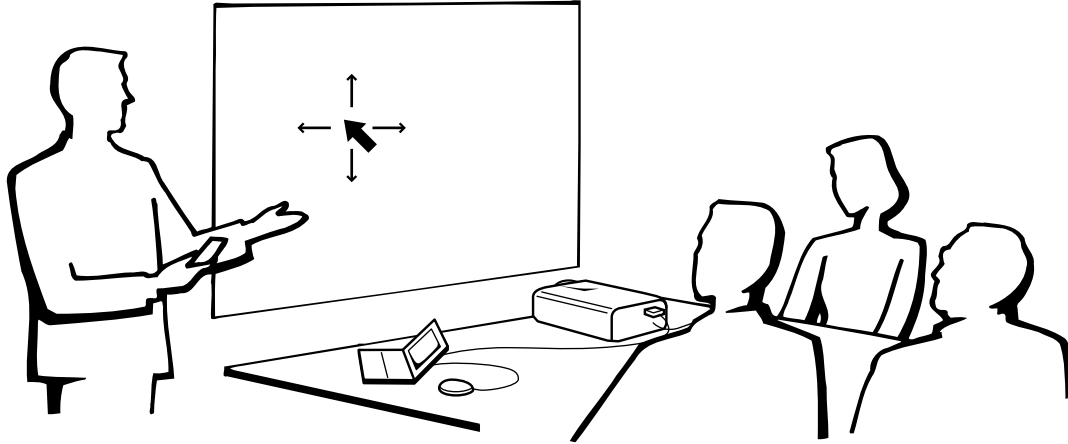

Using the Remote Control as a Wireless Mouse

The remote control has the following three functions:

- Projector control
- Wireless mouse
- Laser pointer

MOUSE/ADJUSTMENT switch (Remote control)

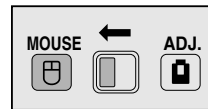

Wireless mouse
Laser pointer

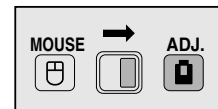

Projector control

Remote Control/Mouse Receiver Positioning

- The remote control can be used to control the projector within the ranges shown below.
- The remote mouse receiver can be used with the remote control to control the mouse functions of a connected computer within the ranges shown below.

NOTE

- The signal from the remote control can be reflected off a screen for easy operation. However, the effective distance of the signal may differ due to the screen material.

Controlling the Projector

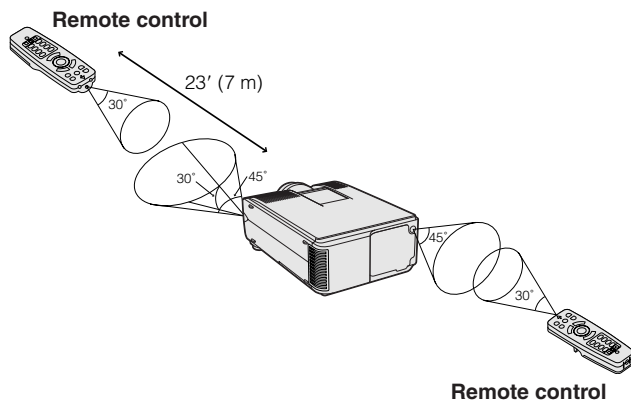

Using the Wireless Mouse

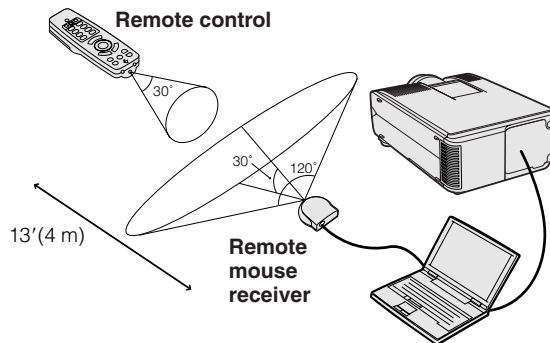

Use as a Wireless Mouse

Be sure the supplied remote mouse receiver is connected to your computer.

1



Slide the **MOUSE/ADJUSTMENT** switch to **MOUSE**.

Effective buttons in **MOUSE** mode

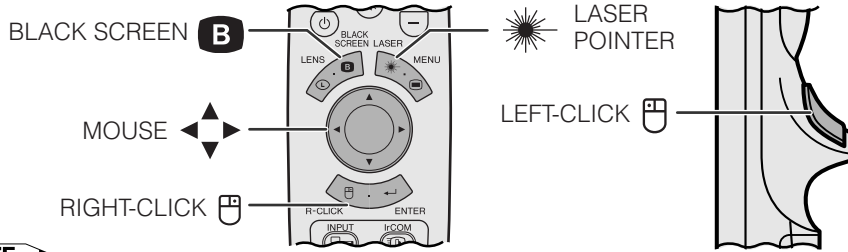

NOTE

- The wireless mouse may not operate correctly if your computer serial port is not correctly set up. Refer to the computer's operation manual for details of setting up/installing the mouse driver.
- For one-button mouse systems, use either the **LEFT-CLICK** or **RIGHT-CLICK** button.

LIGHT



Using the remote control in a dark room

Press **BACKLIGHT**, and the buttons will light up. Green lights refer to mouse operations, and red lights to projector adjustments.

Button name	Position of MOUSE/ADJUSTMENT switch	
	MOUSE (M)	ADJ. (A)
LASER POINTER/MENU	LASER POINTER (GREEN)	MENU (RED)
BLACK SCREEN/LENS	BLACK SCREEN (GREEN)	LENS (RED)
RIGHT-CLICK/ENTER	RIGHT-CLICK (GREEN)	ENTER (RED)
MOUSE/ADJUSTMENT	MOUSE (NOT LIT)	ADJUSTMENT (NOT LIT)
LEFT-CLICK/UNDO	LEFT-CLICK (NOT LIT)	UNDO (NOT LIT)
POWER ON/OFF	ON (RED)	
VOLUME +/-		
MUTE		

Button name	Position of MOUSE/ADJUSTMENT switch	
	MOUSE (M)	ADJ. (A)
INPUT	ON (RED)	
IrCOM		
FREEZE		
AUTO SYNC		
ENLARGE		
RESIZE		
TOOLS		
GAMMA		

Use as a Laser pointer

1



Slide the **MOUSE/ADJUSTMENT** switch to **MOUSE**.

2



Press **LASER POINTER** (*) to activate the laser pointer.

When the button is released, the light automatically goes off.

NOTE

- For safety, the laser pointer automatically goes off after 1 minute of continuous use. To turn it on, release **LASER POINTER** (*) and press again.

Wired Remote Control

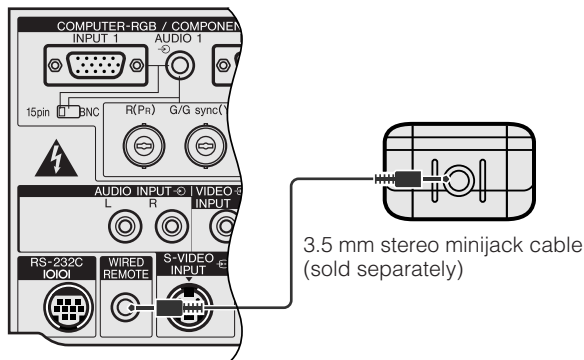

When the remote control cannot be used due to the range or positioning of the projector (rear projection, etc.), connect a 3.5 mm stereo minijack cable (sold separately) from the wired remote control input on the bottom of the remote control to the **WIRED REMOTE** control input terminal on the rear of the projector.

NOTE

- The laser pointer and wireless mouse functions can still be operated with the wired remote control.





Using the GUI (Graphical User Interface) Menu Screens

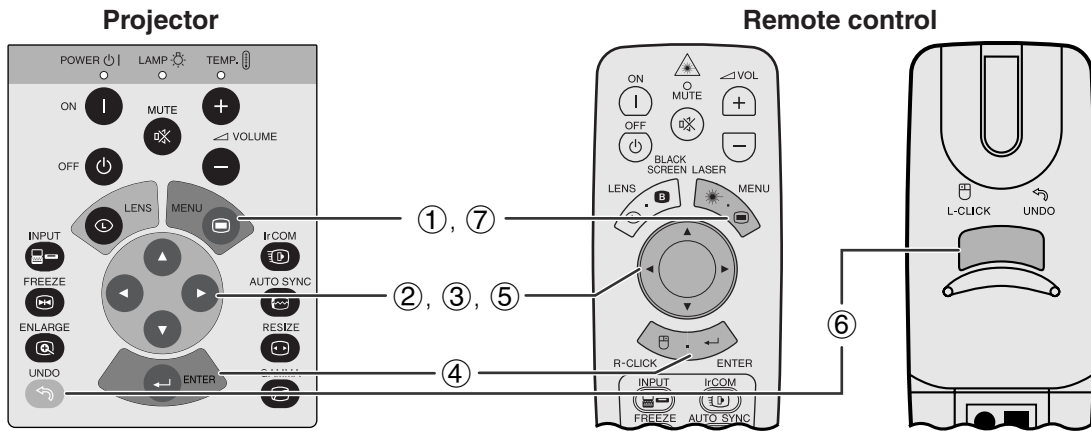

This projector has two sets of menu screens (INPUT/VIDEO) that allow you to adjust the image and various projector settings. These menu screens can be operated from the projector or the remote control with the following buttons.

(GUI) On-screen Display

INPUT (COMPUTER/RGB) mode

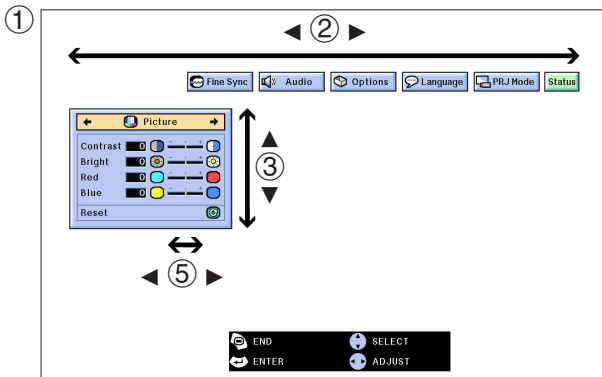

VIDEO mode

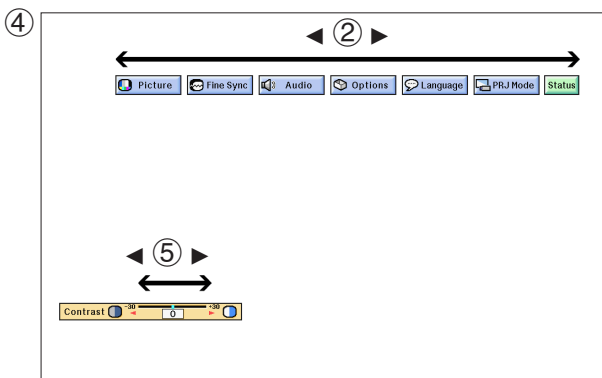
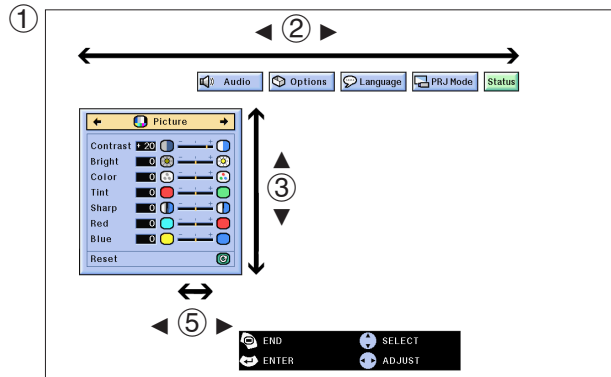

(Slide the **MOUSE/ADJUSTMENT** switch on the remote control to the ADJ. position.)



- ① Press **MENU** to display the INPUT or VIDEO mode menu bar.
- ② Press **◀/▶** to select an adjustment menu on the menu bar.
- ③ Press **▲/▼** to select a specific adjustment item.
- ④ To display a single adjustment item, press **ENTER** after selecting the item. Only the menu bar and the selected adjustment item will appear.
- ⑤ Press **◀/▶** to adjust the item.
- ⑥ Press **UNDO** to return to the previous screen.
- ⑦ Press **MENU** to exit from the GUI.

NOTE

- For details on items on the menu screen, see the tree charts on the next page.





Items on the INPUT1 or INPUT2 Mode Menu Bar

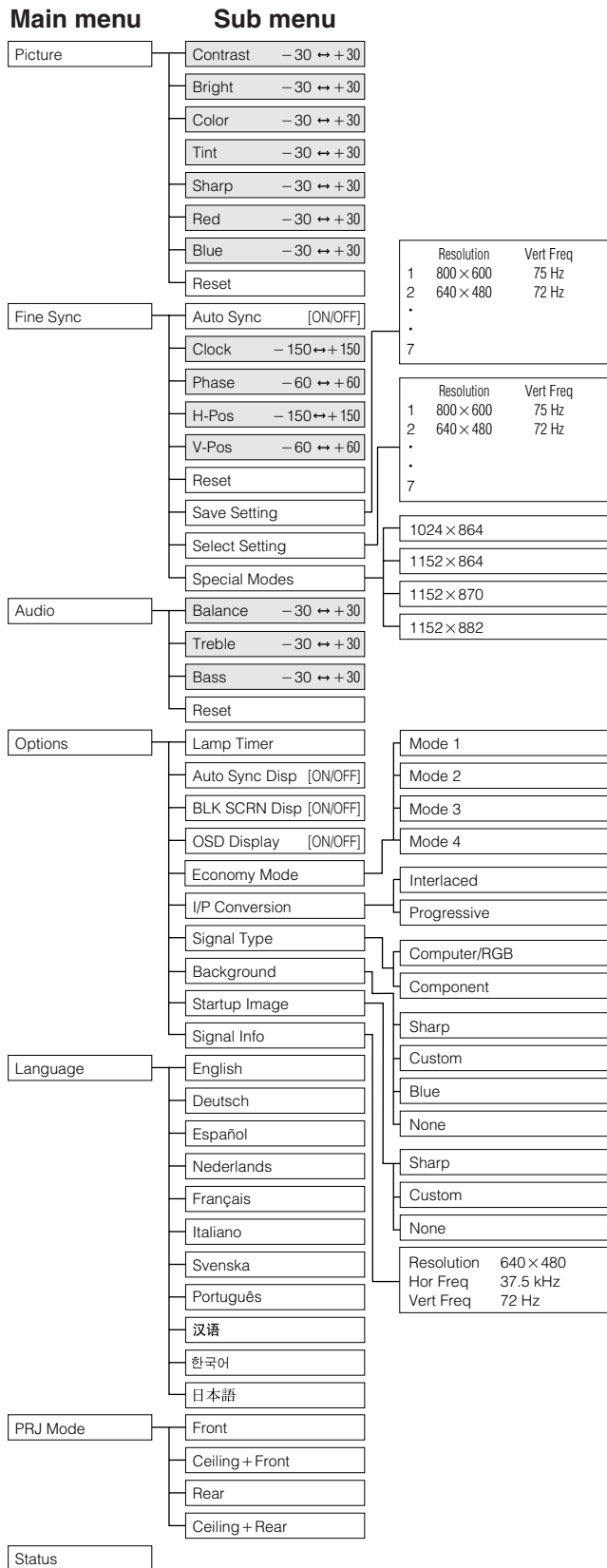

Items on the VIDEO Mode Menu Bar

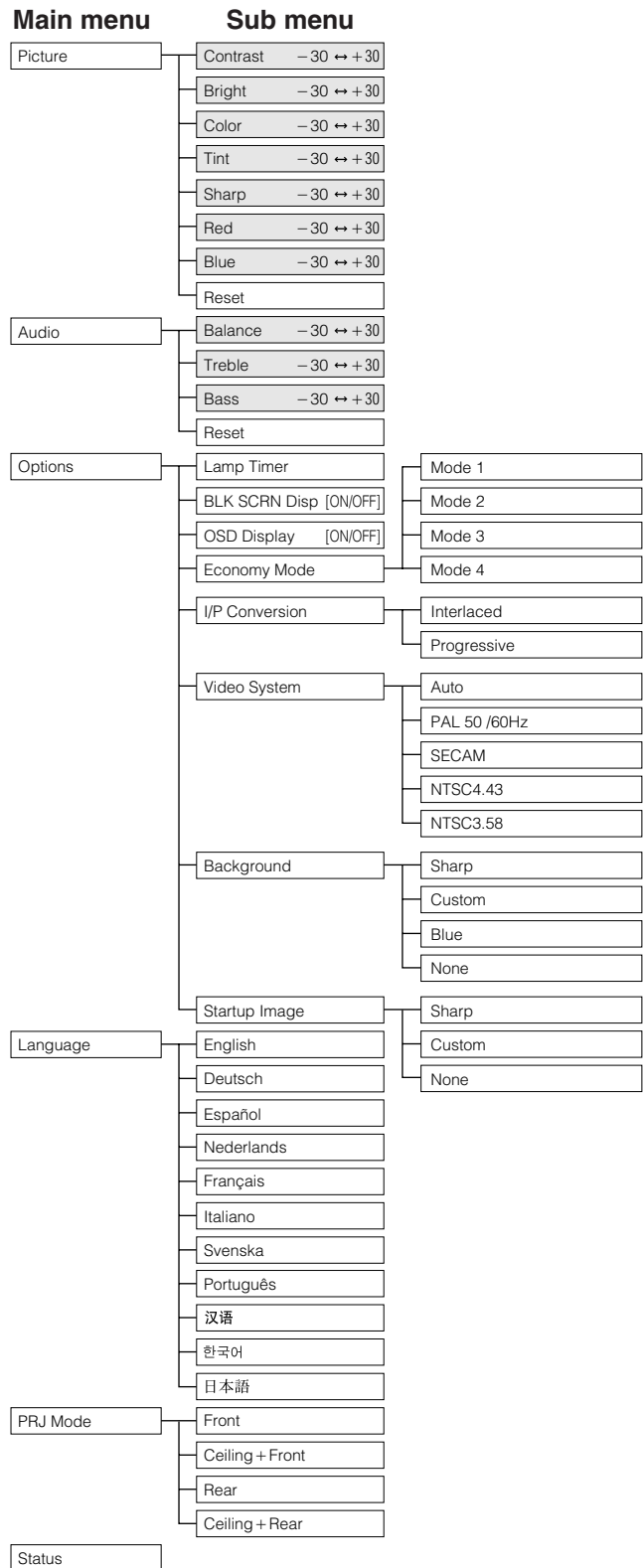

NOTE

- The resolution, vertical frequency and horizontal frequency figures displayed above are for example purposes only.
- “Color”, “Tint”, and “Sharp” appear only when Component input is selected in INPUT mode.
- Only the items highlighted in the tree charts above can be adjusted.
- To adjust the items under the sub menu, press ► after selecting the sub menu.





Using IrCOM for Wireless Presentations

Projector

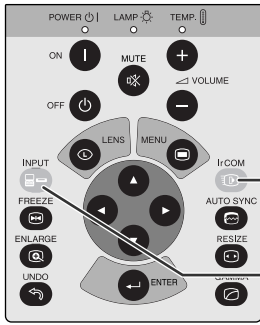

Remote control

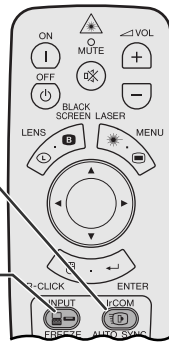

The IrCOM function can transfer still images from a computer or digital camera to the projector via infrared (wireless) communication.

Sharp Advanced Presentation Software

- This function requires the supplied Sharp Advanced Presentation Software (SAPS).
- Install the SAPS in the supplied CD-ROM on the computer.
- See the operation manual of the software for installation and operating instructions.
- Position the projector and the IrCOM transmitting device within the range shown on the left.

IrCOM1

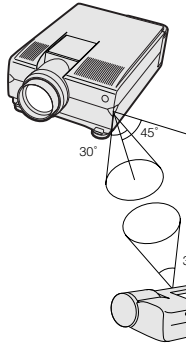

IrCOM2

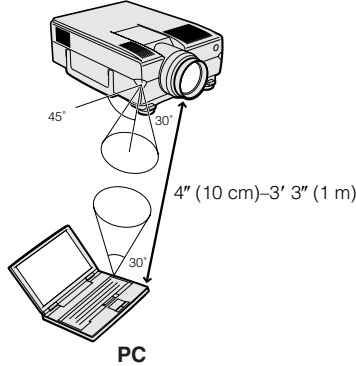

Digital camera

PC

On-screen Display

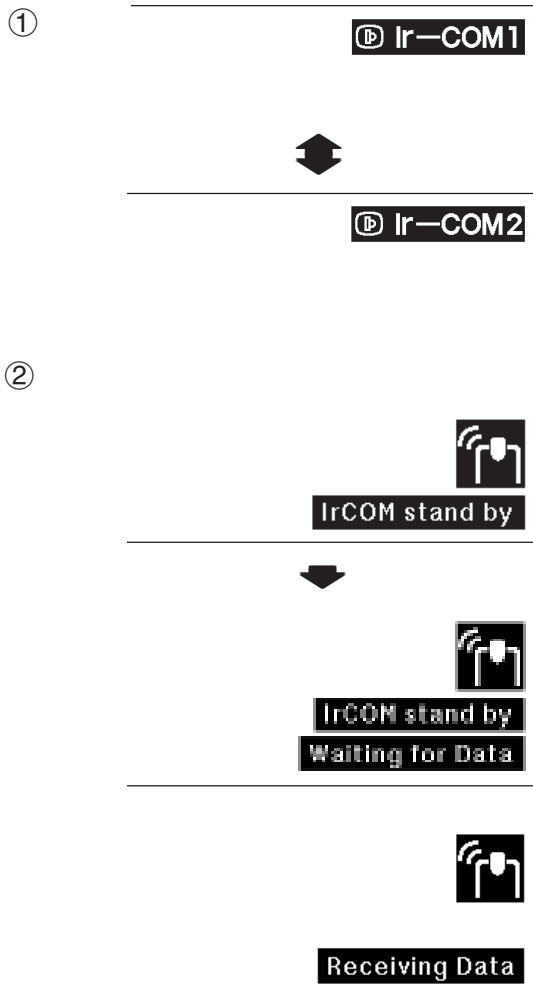

NOTE

- To avoid transmission errors or changes in the image, ensure the following when setting up the projector and transmitting device.
 - The IrCOM sensors on both the projector and transmitting device are protected from direct sunlight or strong ambient light.
 - The transmitting device has sufficient battery power.
 - The projector and transmitting device are positioned within the designated operating range.
 - The IrCOM sensors on the projector and transmitting device are correctly aligned.
- The distance between the projector and transmitting device may have to be less than 4" (10 cm) depending on the transmitting device.
- When using the digital still camera, set it to the image transmission mode and set the computer to the image reception mode.
- Align the projector and transmitting device at the same height and angle at a distance of 4" (10 cm) to 3' 3" (1 meter) with an unobstructed line of view.

(Slide the **MOUSE/ADJUSTMENT** switch on the remote control to the ADJ. position.)

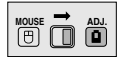

- ① Press **IrCOM** to enter the IrCOM mode. Each time **IrCOM** is pressed, the On-screen Display switches between "Ir-COM1" and "Ir-COM2".
- ② And then the On-screen Display changes as shown on the left.

NOTE

- If the On-screen Display does not change as shown on the left, the projector may not be within the reception range from the IrCOM transmitting device.

- ③ Press **INPUT** to exit the IrCOM mode.

NOTE

- If the projector is unable to receive images from the IrCOM transmitting device, the On-screen display on the left will appear.



Selecting the On-screen Display Language

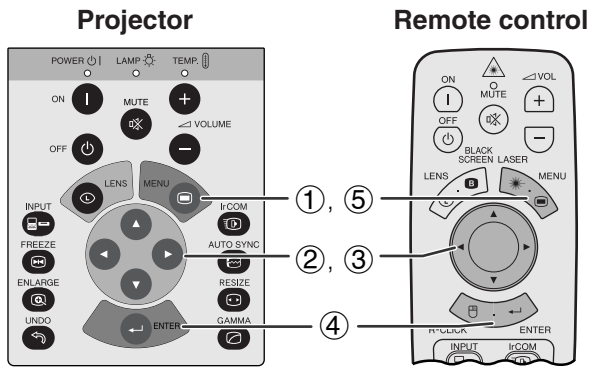

English is the preset language for the On-screen Display. It can be changed to English, German, Spanish, Dutch, French, Italian, Swedish, Portuguese, Chinese, Korean or Japanese.

(Slide the **MOUSE/ADJUSTMENT** switch on the remote control to the ADJ. position.)

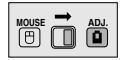

- ① Press **MENU**.
- ② Press ◀▶ to select “Language”.
- ③ Press ▲/▼ to select the desired language .
- ④ Press **ENTER** to save the setting. The On-screen Display is now programed to display in the language selected.
- ⑤ To exit from the GUI, press **MENU**.

(GUI) On-screen Display



Selecting the Video Input System Mode (VIDEO mode only)

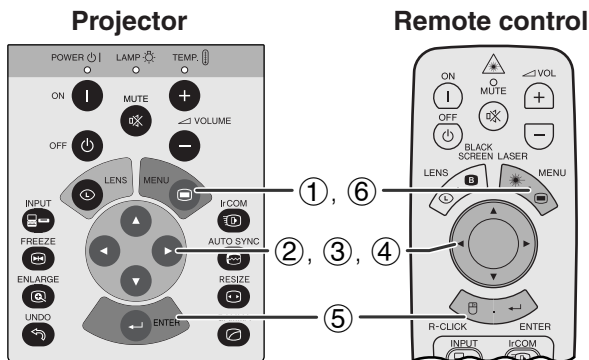

The video input system mode is preset to “Auto”; however, it can be changed to a specific system mode, if the selected system mode is not compatible with the connected audiovisual equipment.

(Slide the **MOUSE/ADJUSTMENT** switch on the remote control to the ADJ. position.)

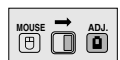

- ① Press **MENU**.
- ② Press ◀▶ to select “Options”.
- ③ Press ▲/▼ to select “Video System”, and then press ▶.
- ④ Press ▲/▼ to select the desired video system mode.
- ⑤ Press **ENTER** to save the setting.
- ⑥ To exit from the GUI, press **MENU**.

(GUI) On-screen Display

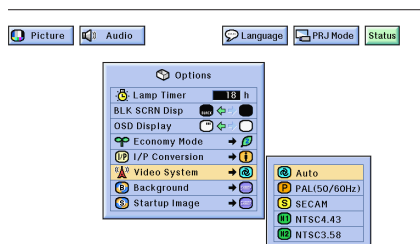

NOTE

- When the system mode is set to “Auto”, you may not receive a clear picture due to signal differences. Should this occur, switch to the video system you are viewing.





Picture Adjustments

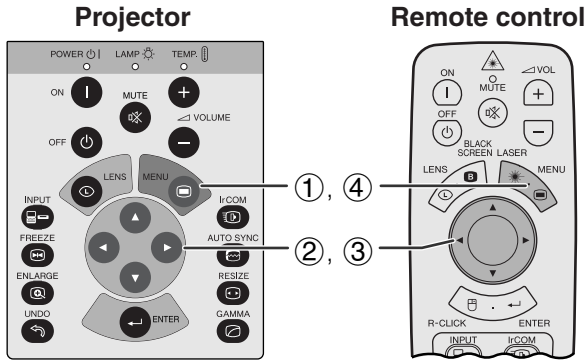

You can adjust the projector's picture to your preferences with the following picture settings.

Description of Adjustment Items

Selected item	◀ button	▶ button
Contrast	For less contrast	For more contrast
Bright	For less brightness	For more brightness
Color	For less color intensity	For more color intensity
Tint	Skin tones become purplish	Skin tones become greenish
Sharp	For less sharpness	For more sharpness
Red	For weaker red	For stronger red
Blue	For weaker blue	For stronger blue
Reset	All image adjustment items are returned to the factory preset settings.	

(GUI) On-screen Display (COMPUTER/RGB input in INPUT mode)

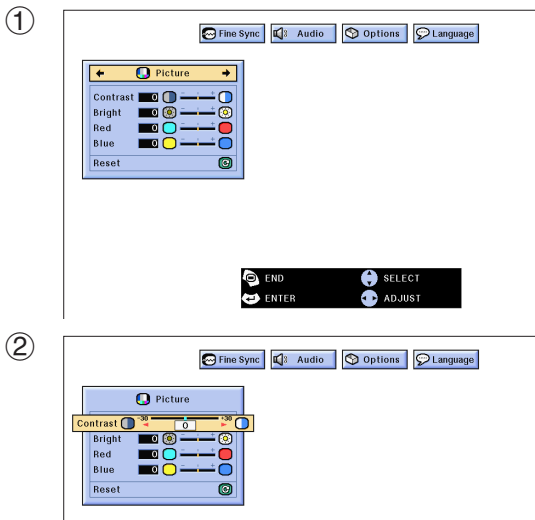

NOTE

- “Color”, “Tint” and “Sharp” do not appear for COMPUTER/RGB input in INPUT mode.

(Slide the **MOUSE/ADJUSTMENT** switch on the remote control to the ADJ. position.)



- 1 Press **MENU**. Menu bar and “Picture” menu screen appear. GUI operation guide is also displayed.
- 2 Press ▲/▼ to select a specific adjustment item.
- 3 Press ◀/▶ to move the ● mark of the selected adjustment item to the desired setting.
- 4 To exit from the GUI, press **MENU**.

NOTE

- To reset all adjustment items, select “Reset” on the “Picture” menu screen and press **ENTER**.
- The adjustments can be stored separately in the “INPUT 1”, “INPUT 2” and “VIDEO” modes.
- For COMPONENT input in INPUT mode, “Sharp” is adjustable only when a DVD player is connected.



Audio Adjustments

Projector

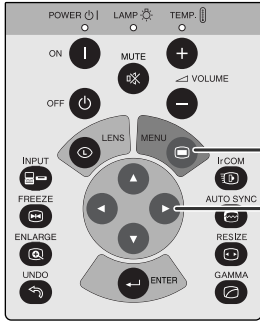

Remote control

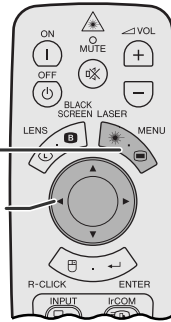

This projector's audio is factory preset to standard settings. However, you can adjust it to suit your own preferences by adjusting the following audio settings.

Description of Adjustment Items

Selected item	◀ button	▶ button
Balance	Increased audio from the left speaker	Increased audio from the right speaker
Treble	For weaker treble	For stronger treble
Bass	For weaker bass	For stronger bass
Reset	All audio adjustment items are returned to the factory preset settings.	

(GUI) On-screen Display

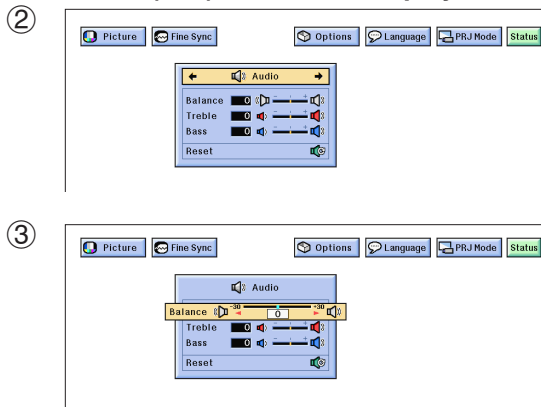

(Slide the **MOUSE/ADJUSTMENT** switch on the remote control to the ADJ. position.)



- Press **MENU**. Menu bar and "Picture" menu screen appear. GUI operation guide is also displayed.
- Press ◀/▶ to select "Audio".
- Press ▲/▼ to select a specific adjustment item.
- Press ◀/▶ to move the ● mark of the selected adjustment item to the desired setting.
- To exit from the GUI, press **MENU**.

NOTE

- To reset all adjustment items, select "Reset" on the "Audio" menu screen and press **ENTER**.





Computer Image Adjustments

Projector

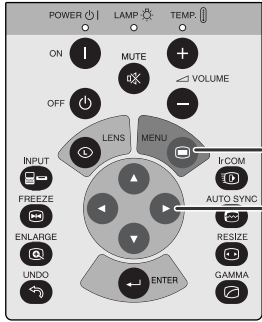

Remote control

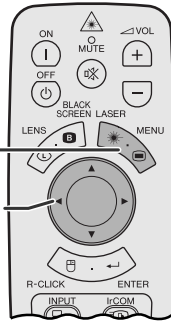

When displaying computer patterns which are very detailed (tiling, vertical stripes, etc.), interference may occur between the LCD pixels, causing flickering, vertical stripes, or contrast irregularities in portions of the screen. Should this occur, adjust “Clock”, “Phase”, “H-Pos” and “V-Pos” for optimum computer image.

Description of Adjustment Items

Selected item	Description
Clock	Adjusts vertical noise.
Phase	Adjusts horizontal noise (similar to tracking on your VCR).
H-Pos	Centers the on-screen image by moving it to the left or right.
V-Pos	Centers the on-screen image by moving it up or down.

NOTE

- Computer image adjustment can be made easily by pressing **AUTO SYNC** (). See the next page for details.

(GUI) On-screen Display

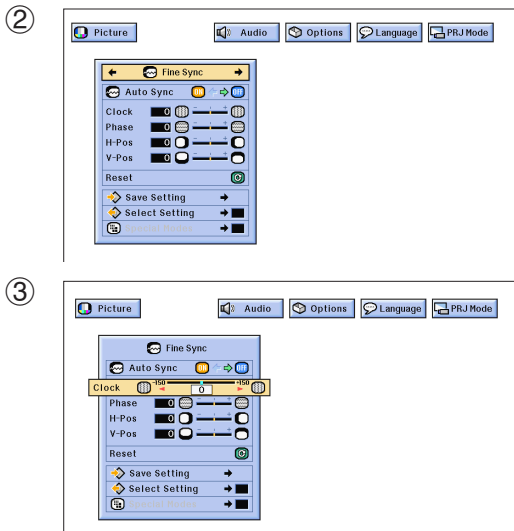

(Select the desired computer input mode with **INPUT**.)

(Slide the **MOUSE/ADJUSTMENT** switch on the remote control to the **ADJ.** position.)

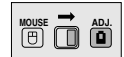

- ① Press **MENU**. Menu bar and “Picture” menu screen appear. GUI operation guide is also displayed.
- ② Press **◀/▶** to select “Fine Sync”.
- ③ Press **▲/▼** to select a specific adjustment item.
- ④ Press **◀/▶** to move the **●** mark of the selected adjustment item to the desired setting.
- ⑤ To exit from the GUI, press **MENU**.

NOTE

- To reset all adjustment items, select “Reset” on the “Fine Sync” menu screen and press **ENTER**.



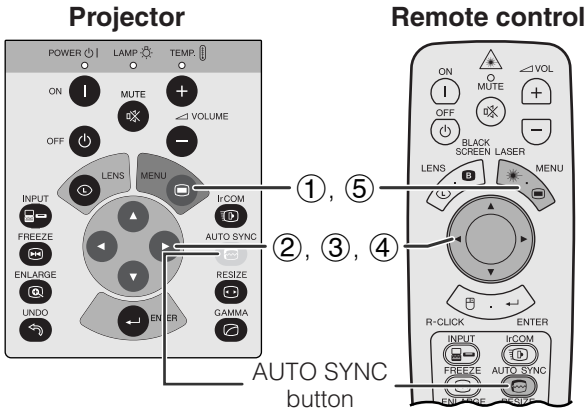

Auto Sync Adjustment

- Used to automatically adjust a computer image.
- Auto Sync adjustment can be made manually by pressing **AUTO SYNC**, or automatically by setting “Auto Sync” to “ON” in the projector’s GUI menu.

When “Auto Sync” is set to “ON”:

- The **sync** adjustment is automatically made each time the projector is turned on while connected to a computer or the input selection is changed.
- The Auto Sync adjustment setting previously made is cleared when the projector’s setting is changed.

(Slide the **MOUSE/ADJUSTMENT** switch on the remote control to the ADJ. position.)



(GUI) On-screen Display

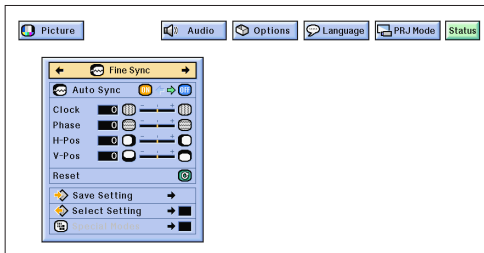

- ① Press **MENU**.
- ② Press ◀/▶ to select “Fine Sync”.
- ③ Press ▲/▼ to select “Auto Sync”.
- ④ Press ◀/▶ to select “ON”.
- ⑤ To exit from the GUI, press **MENU**.

NOTE

- Automatic adjustments can be made by pressing **AUTO SYNC**.
- When the optimum image cannot be achieved with Auto Sync adjustment, use manual adjustments. (See the previous page.)

On-screen Display



During Auto Sync adjustment, the On-screen Display changes as shown on the left.

NOTE

- Auto Sync adjustment may take some time to complete, depending on the image of the computer connected to the projector.

Auto Sync Display Function

Normally, an image is not superimposed during Auto Sync adjustment. You can, however, choose to superimpose a background image during Auto Sync adjustment.

(Slide the **MOUSE/ADJUSTMENT** switch on the remote control to the ADJ. position.)

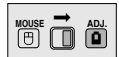

(GUI) On-screen Display

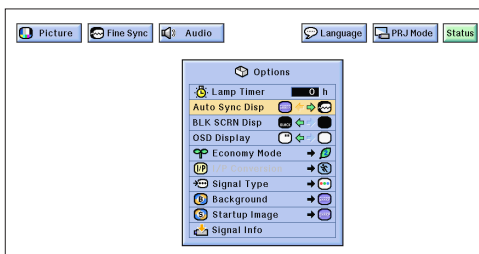

- ① Press **MENU**.
- ② Press ◀/▶ to select “Options”.
- ③ Press ▲/▼ to select “Auto Sync Disp”.
- ④ Press ◀/▶ to select “□” to superimpose a background image or “☺” to remove the background image during Auto Sync adjustment.
- ⑤ To exit from the GUI, press **MENU**.

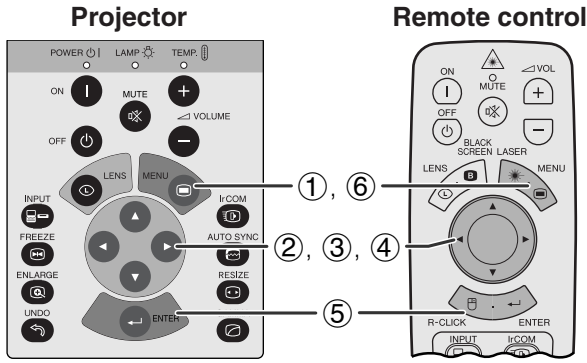

(GUI) On-screen Display

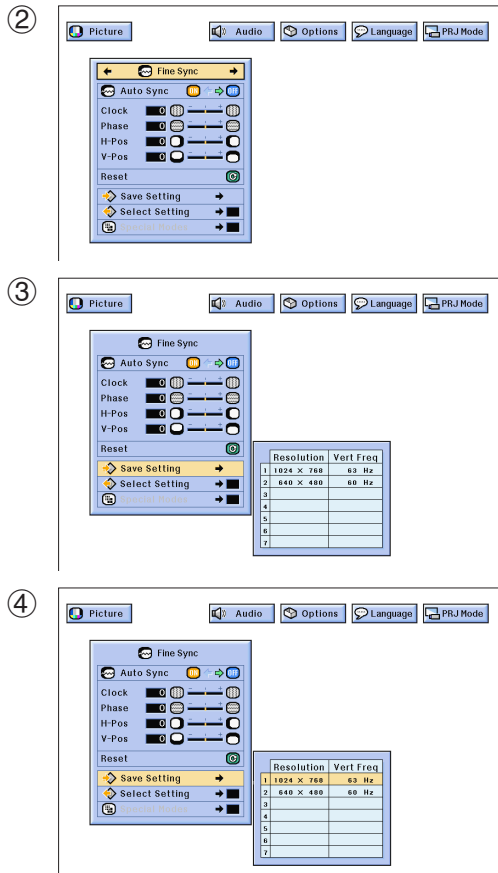

Saving and Selecting Adjustment Settings

This projector allows you to store up to seven adjustment settings for use with various computers. Once these settings are stored, they can be easily selected each time you connect the computer to the projector.

Saving the adjustment setting

(Slide the **MOUSE/ADJUSTMENT** switch on the remote control to the ADJ. position.)



- ① Press **MENU**.
- ② Press ◀▶ to select “Fine Sync”.
- ③ Press ▲/▼ to select “Save Setting”, and then press ▶.
- ④ Press ▲/▼ to select the desired memory location of the setting.
- ⑤ Press **ENTER** to save the setting.
- ⑥ To exit from the GUI, press **MENU**.

Selecting a saved setting

(Slide the **MOUSE/ADJUSTMENT** switch on the remote control to the ADJ. position.)



- ① Press **MENU**.
- ② Press ◀▶ to select “Fine Sync”.
- ③ Press ▲/▼ to select “Select Setting”, and then press ▶.
- ④ Press ▲/▼ to select the desired memory setting.
- ⑤ Press **ENTER** to select the setting.
- ⑥ To exit from the GUI, press **MENU**.

NOTE

- If the memory position has not been set, the resolution and frequency will not be displayed.
- When selecting the stored adjustment setting with “Select Setting”, the computer system should match the stored setting.

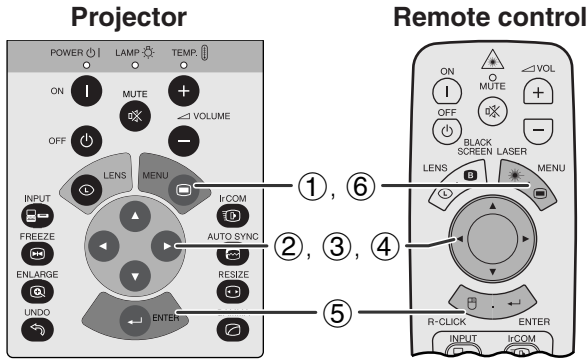

(GUI) On-screen Display

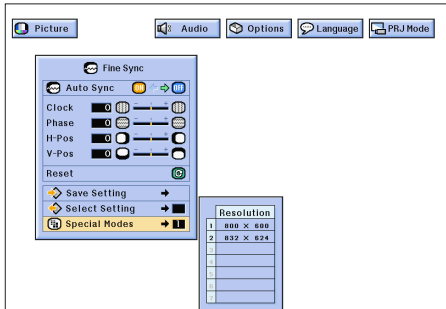

Special Mode Adjustment

Ordinarily, the type of input signal is detected and the correct resolution mode is automatically selected. However, for some signals, "Special Modes" on the "Fine Sync" menu screen may need to be changed to match the computer display mode.

(Slide the **MOUSE/ADJUSTMENT** switch on the remote control to the ADJ. position.)

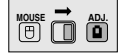

- ① Press **MENU**.
- ② Press ◀▶ to select "Fine Sync".
- ③ Press ▲/▼ to select "Special Modes".
- ④ Press ▲/▼ to select the optimal resolution mode.
- ⑤ Press **ENTER** to save the setting.
- ⑥ To exit from the GUI, press **MENU**.

NOTE

- Avoid displaying computer patterns which repeat every other line (horizontal stripes). (Flickering may occur, making the image hard to see.)
- When inputting DTV 480P signals, select "480P" in step ④ above.





Useful Features

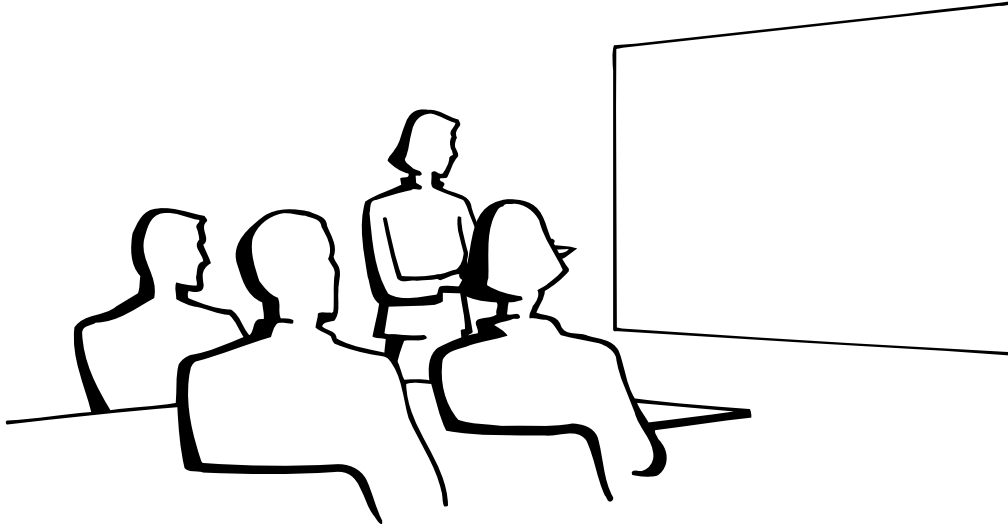

Freeze Function

Projector

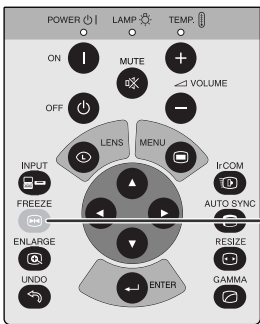

Remote control

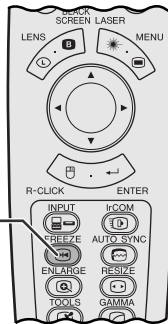

This function allows you to instantly freeze a moving image. This is useful when you want to display a still image from a computer or video, giving you more time to explain the image to the audience.

You can also use this function to display a still image from a computer while you make preparations for the next computer images to be presented.

- ① Press **FREEZE** to freeze the image.
- ② Press **FREEZE** again to return to the moving image.

On-screen Display





Digital Image Magnification

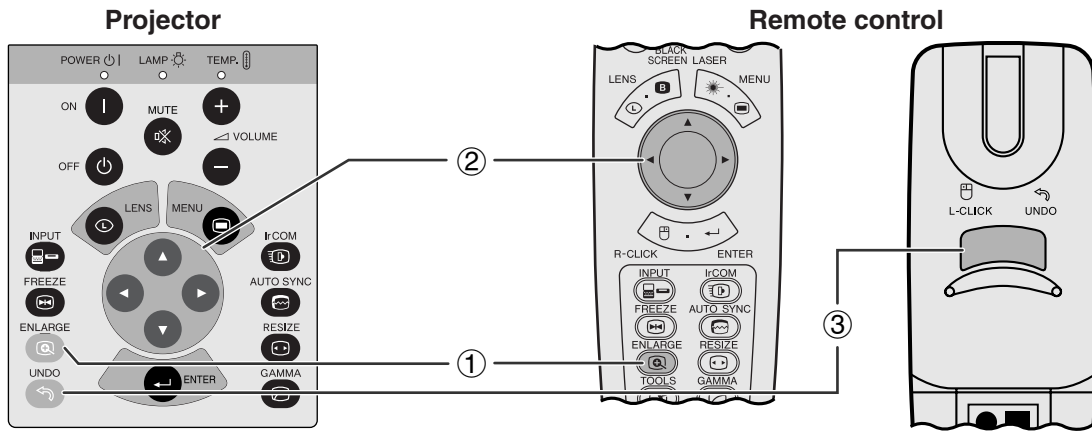

On-screen Display

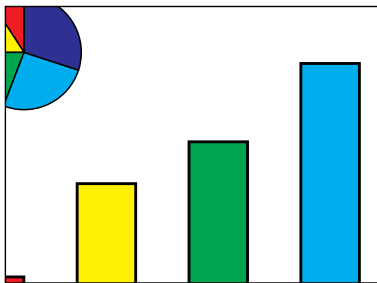
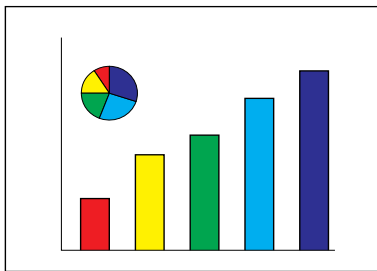

This function allows you to magnify a specific portion of an image. This is useful when you want to display a detailed portion of the image.

(Slide the **MOUSE/ADJUSTMENT** switch on the remote control to the **ADJ.**)

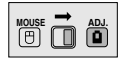

- ① Press **ENLARGE**. Each time **ENLARGE** is pressed, the image will be magnified.
- ② When the image is magnified, you can pan and scan around the image by using **▲/▼/◀/▶**.

NOTE

- Each time **ENLARGE** is pressed, image magnification toggles as shown below.

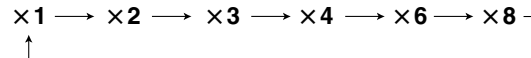

- If the input signal is changed during digital image magnification, the image will return to $\times 1$. The input signal is changed
 - (a) when **INPUT** is pressed,
 - (b) when the input signal is interrupted, or
 - (c) when the input resolution and refresh rate changes.

- ③ To return to $\times 1$, press **UNDO**.





Gamma Correction

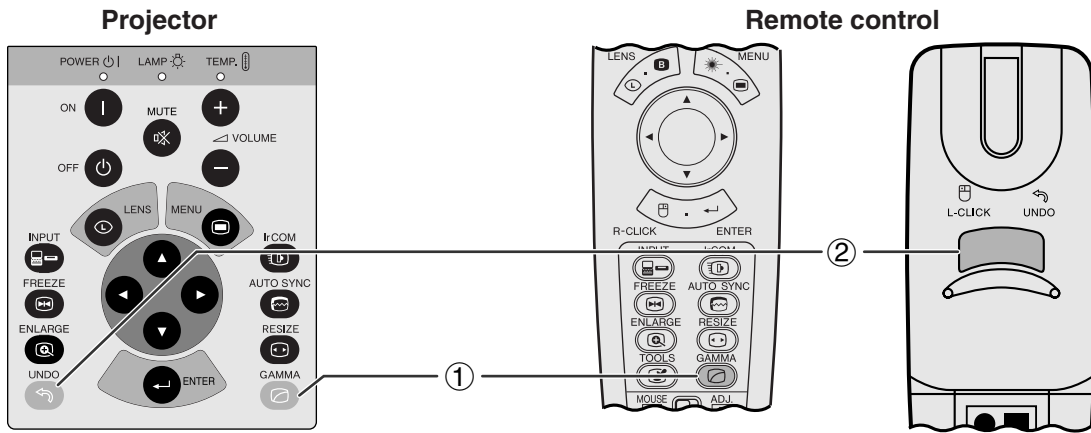

On-screen Display

STANDARD

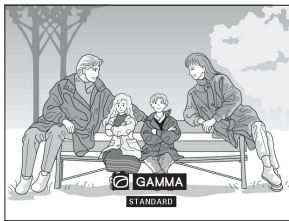

GAMMA 1

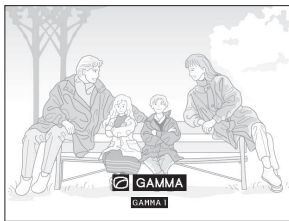

GAMMA 2

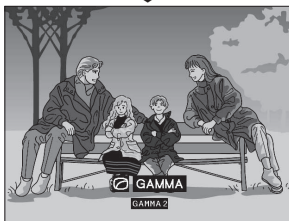

CUSTOM

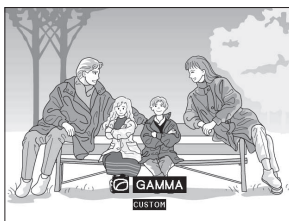

- Gamma is an image quality enhancement function that offers a richer image by brightening the darker portions of the image without altering the brightness of the brighter portions.
- Four gamma settings are available to allow for differences in the images played and in the brightness of the room.
- When you are watching images with frequent, dark scenes, such as a film or concert, or when you are watching images in a bright room, this feature makes the dark scenes easier to see and gives the impression of greater depth in the image.

Gamma Modes

Selected Mode	Gamma mode
STANDARD	Standard picture without gamma correction.
GAMMA 1	Brightens darker portions of image.
GAMMA 2	Gives greater depth to darker portions of image.
CUSTOM	Allows you to adjust gamma value using Sharp Advanced Presentation Software.

(Slide the **MOUSE/ADJUSTMENT** switch on the remote control to the ADJ. position.)

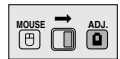

- ① Press **GAMMA**. Each time **GAMMA** is pressed, the gamma level toggles as shown on the left.
- ② To return to the standard image, press **UNDO** while "GAMMA" is displayed on the screen.

Black Screen Function

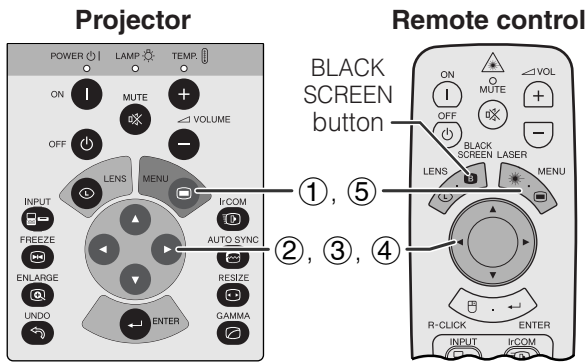

This function can be used to superimpose a black screen over the projected image.

Blacking out the Projected Image

Press **BLACK SCREEN**. “BLACK SCREEN” is displayed on the screen. To return to the original projected image, press **BLACK SCREEN** again.

NOTE

- To use the remote control to operate this function, slide the **MOUSE/ADJUSTMENT** switch to the **MOUSE** position before pressing **BLACK SCREEN**.

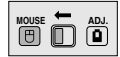

Projected Image

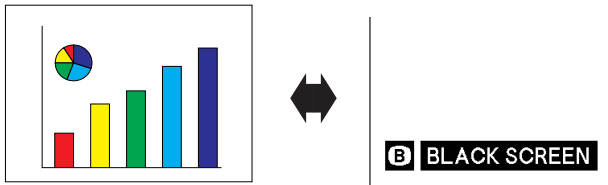

(GUI) On-screen Display

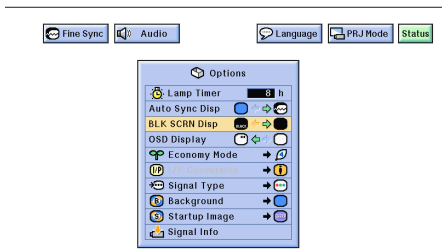

Turning off the On-screen Display

The On-screen Display (“BLACK SCREEN”) that appears during black screen can be turned off. When “BLK SCRNR Disp” is set to “OFF” in the GUI menu, “BLACK SCREEN” will not be displayed during function.

(Slide the **MOUSE/ADJUSTMENT** switch on the remote control to the **ADJ.** position.)

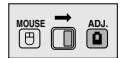

- Press **MENU**.
- Press **Left/Right Arrow** to select “Options”.
- Press **Up/Down Arrow** to select “BLK SCRNR Disp”.
- Press **Left/Right Arrow** to select “OFF” to turn on or “ON” to turn off the function.
- To exit from the GUI, press **MENU**.

On-screen Display Override Function

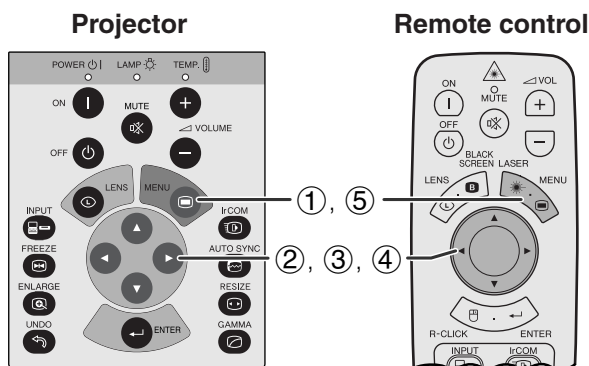

This function allows you to turn off the on-screen messages that appear during “input select” and the “IrCOM” function. Once “OSD Display” is set to “OFF” in the GUI menu, the on-screen messages will not appear when **INPUT** and **IrCOM** are pressed.

(Slide the **MOUSE/ADJUSTMENT** switch on the remote control to the **ADJ.** position.)

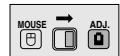

(GUI) On-screen Display

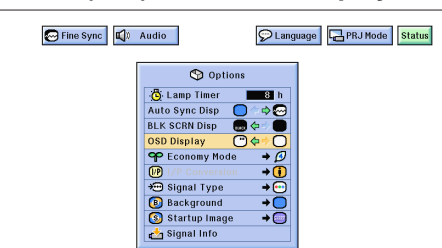

- Press **MENU**.
- Press **Left/Right Arrow** to select “Options”.
- Press **Up/Down Arrow** to select “OSD Display”.
- Press **Left/Right Arrow** to select “OFF” to turn on or “ON” to turn off the On-screen Display.
- To exit from the GUI, press **MENU**.



Selecting the Economy Mode

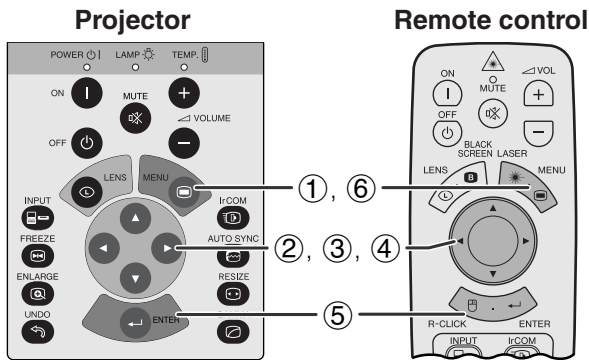

(GUI) On-screen Display

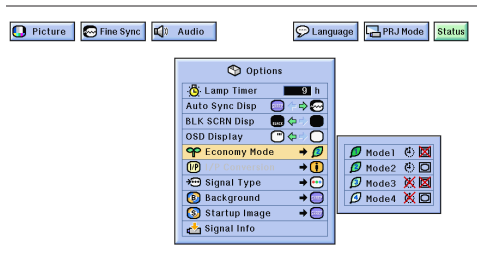

On-screen Display

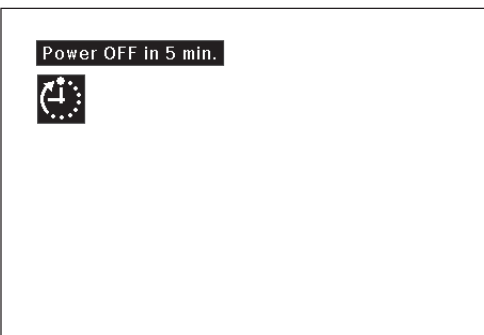

This function allows you to reduce the power consumption when the projector is off.

Economy Modes

Selected mode	Automatic Power Shutoff	RS232C/Monitor out
Mode 1	ON	OFF
Mode 2	ON	ON
Mode 3	OFF	OFF
Mode 4	OFF	ON

NOTE

- The projector is factory preset to Mode 2.

(Slide the **MOUSE/ADJUSTMENT** switch on the remote control to the **ADJ.** position.)

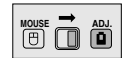

- Press **MENU**.
- Press **◀/▶** to select "Options".
- Press **▲/▼** to select "Economy Mode", and then press **▶**.
- Press **▲/▼** to select the desired mode.
- Press **ENTER** to save the setting.
- To exit from the GUI, press **MENU**.

Automatic Power Shutoff Function

When no input signal is detected for more than 15 minutes, the projector will automatically shut off. The on-screen message on the left will appear five minutes before the power is automatically turned off.

CAUTION

- Select Mode 2 or Mode 4 when using the Sharp Advanced Presentation Software (supplied).





I/P Conversion

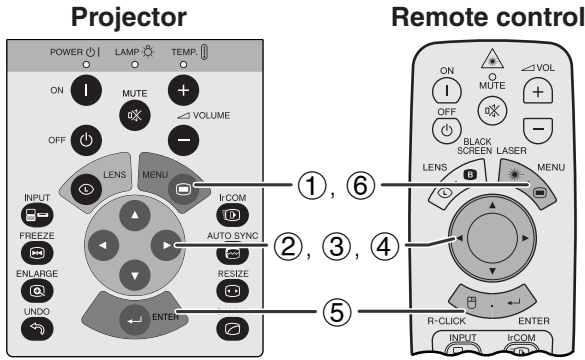

(GUI) On-screen Display

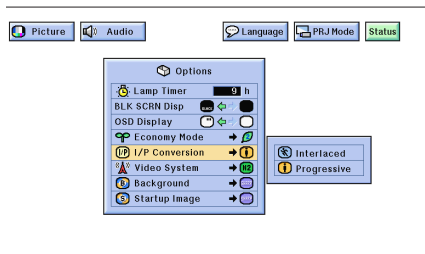

This function allows you to select either an interlaced display or a progressive display of a video signal. The progressive display projects a smooth video image.

(Slide the **MOUSE/ADJUSTMENT** switch on the remote control to the ADJ. position.)



- ① Press **MENU**.
- ② Press ◀▶ to select "Options".
- ③ Press ▲/▼ to select "I/P Conversion", and then press ▶.
- ④ Press ▲/▼ to select "Interlaced" or "Progressive".
- ⑤ Press **ENTER** to save the setting.
- ⑥ To exit from the GUI, press **MENU**.



Checking the Lamp Usage Time

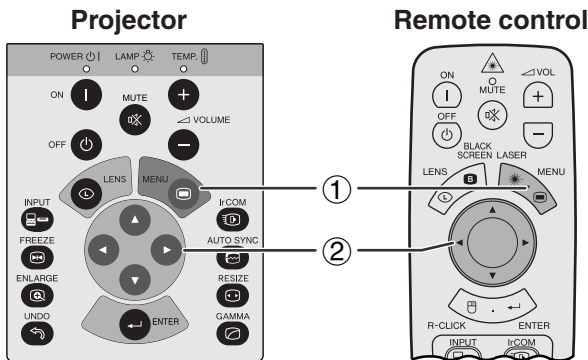

(GUI) On-screen Display

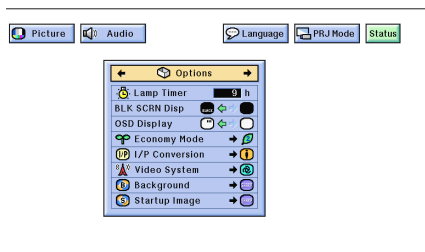

This function allows you to check the accumulated lamp usage time.

(Slide the **MOUSE/ADJUSTMENT** switch on the remote control to the ADJ. position.)

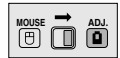

- ① Press **MENU**.
- ② Press ◀▶ to select "Options". The lamp usage time will be displayed.

NOTE

- It is recommended that the lamp be replaced after approximately 2,000 hours of usage. See pages 48 and 49 for lamp replacement.

Selecting the Signal Type

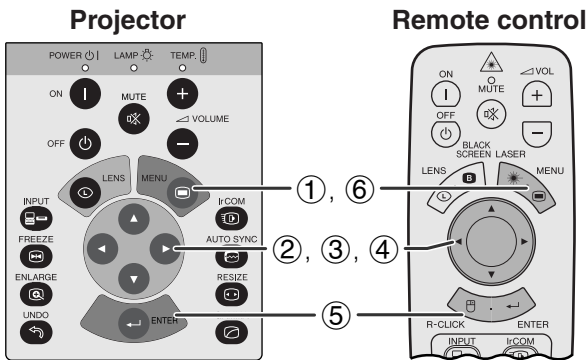

(GUI) On-screen Display

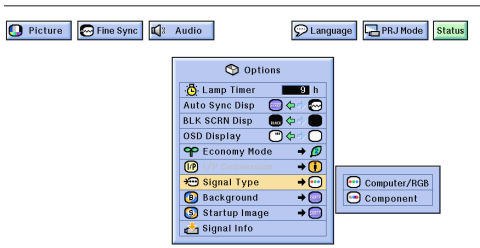

This function allows you to select the input signal type.

(Slide the **MOUSE/ADJUSTMENT** switch on the remote control to the ADJ. position.)

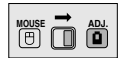

- ① Press **MENU**.
- ② Press ◀/▶ to select “Options”.
- ③ Press ▲/▼ to select “Signal Type”, and then press ▶.
- ④ Press ▲/▼ to select “Computer/RGB” or “Component”.
- ⑤ Press **ENTER** to save the setting.
- ⑥ To exit from the GUI, press **MENU**.

Checking the Input Signal

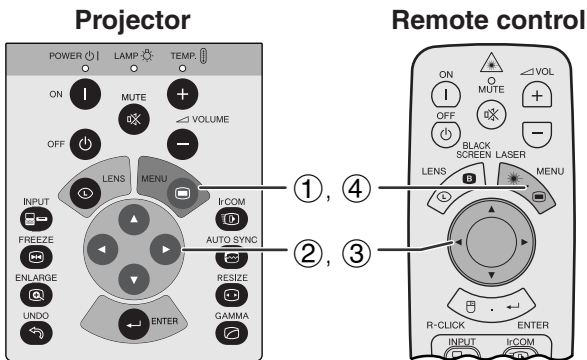

(GUI) On-screen Display

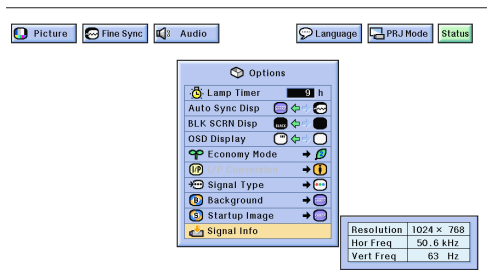

This function allows you to check the current input signal information.

(Slide the **MOUSE/ADJUSTMENT** switch on the remote control to the ADJ. position.)

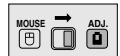

- ① Press **MENU**.
- ② Press ◀/▶ to select “Options”.
- ③ Press ▲/▼ to select “Signal Info” to display the current input signal.
- ④ To exit from the GUI, press **MENU**.

NOTE

- In VIDEO mode, the resolution and frequency settings will not be displayed.





Setting a Background Image

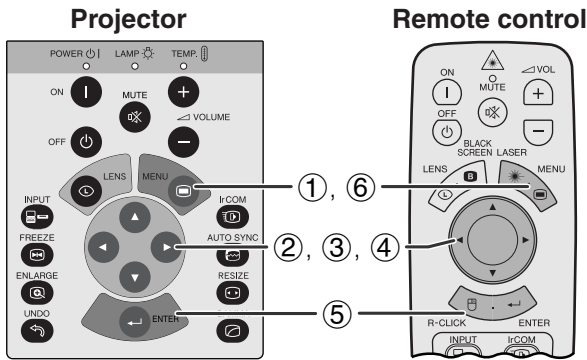

This function allows you to select the image displayed when no signal is being sent to the projector.

Description of Background Images

Selected item	Background image
Sharp	SHARP default image
Custom	User customized image (i.e. company logo)
Blue	Blue screen
None	Black screen

(Slide the **MOUSE/ADJUSTMENT** switch on the remote control to the ADJ. position.)



- ① Press **MENU**.
- ② Press ◀▶ to select "Options".
- ③ Press ▲/▼ to select "Background", and then press ▶.
- ④ Press ▲/▼ to select the background image you want to display on the screen.
- ⑤ Press **ENTER** to save the setting.
- ⑥ To exit from the GUI, press **MENU**.

NOTE

- By selecting "Custom", the projector can display a custom image (i.e. your company logo) as the background image. Custom image must be 256-color BMP file with a picture size of 1,024 × 768 or lower. Please see the Sharp Advanced Presentation Software operation manual for how to save (or change) a custom image.

(GUI) On-screen Display

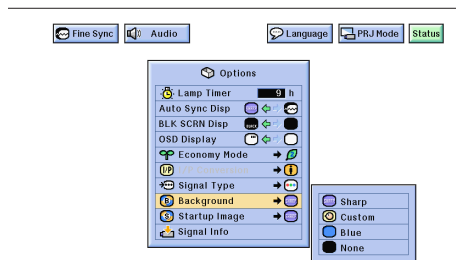

Selecting a Startup Image

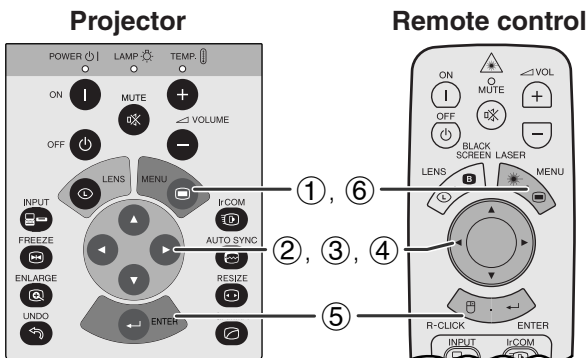

- This function allows you to specify the image to be displayed upon the projector's startup.
- A custom image (i.e. your company logo) can be loaded on the projector via IrCOM or an RS-232C cable. See pages 14 and 25 in this operation manual, and also the supplied Sharp Advanced Presentation Software operation manual for detailed instructions.

Description of Startup Images

Selected item	Startup image
Sharp	SHARP default image
Custom	User customized image (i.e. company logo)
None	Black screen

(Slide the **MOUSE/ADJUSTMENT** switch on the remote control to the ADJ. position.)

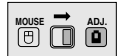

- ① Press **MENU**.
- ② Press ◀▶ to select "Options".
- ③ Press ▲/▼ to select "Startup Image", and then press ▶.
- ④ Press ▲/▼ to select the startup image you want to display on the screen.
- ⑤ Press **ENTER** to save the setting.
- ⑥ To exit from the GUI, press **MENU**.

NOTE

- By selecting "Custom", the projector can display a custom image (i.e. your company logo) as the startup image. Custom image must be 256-color BMP file with a picture size of 1,024 × 768 or lower. Please see the Sharp Advanced Presentation Software operation manual for how to save (or change) a custom image.



Reverse/Invert Image Function

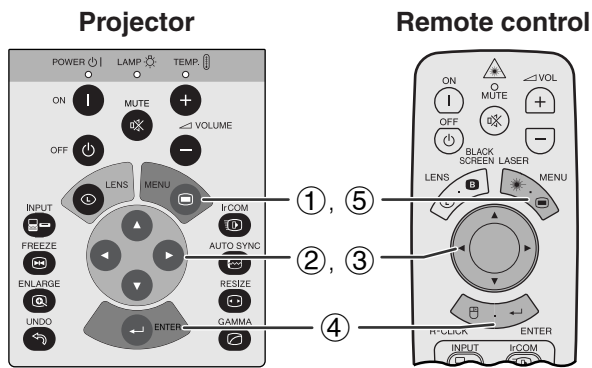

This projector is equipped with a reverse/invert image function which allows you to reverse or invert the projected image for various applications.

Description of Projected Images

Selected Item	Projected image
Front	Normal image
Ceiling + Front	Inverted image
Rear	Reversed image
Ceiling + Rear	Reversed and inverted image

(GUI) On-screen Display

When Selecting "Front"

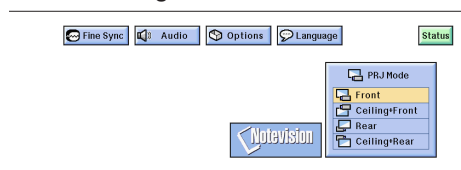

When Selecting "Ceiling + Front"

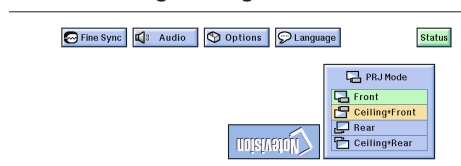

When Selecting "Rear"

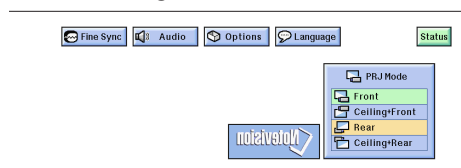

When Selecting "Ceiling + Rear"

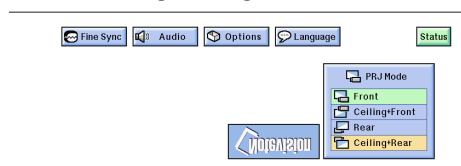

(Slide the **MOUSE/ADJUSTMENT** switch on the remote control to the **ADJ.** position.)

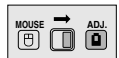

- ① Press **MENU**.
- ② Press **◀/▶** to select "PRJ Mode".
- ③ Press **▲/▼** to select the desired projection mode.
- ④ Press **ENTER** to save the setting.
- ⑤ To exit from the GUI, press **MENU**.

NOTE

- This function is used for the reversed image and ceiling-mount setups. See page 20 for these setups.





Using the Presentation Tools

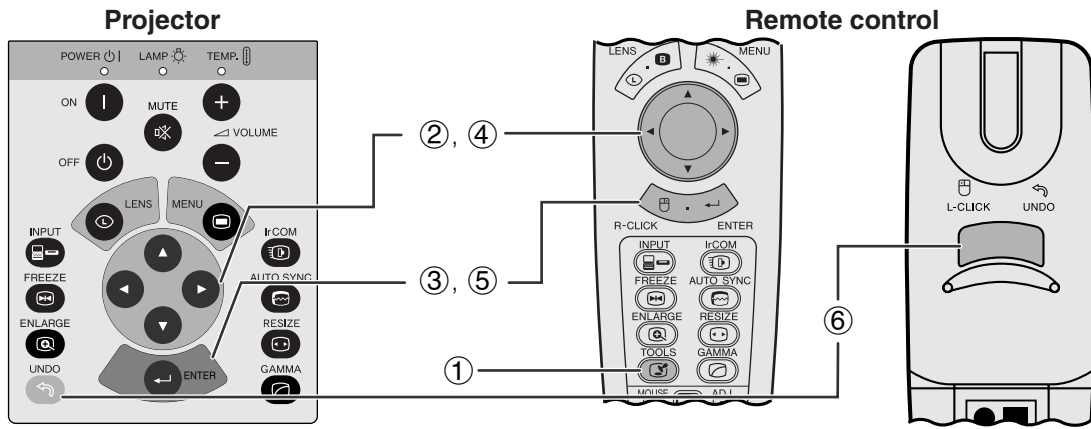

On-screen Display



Menu Window

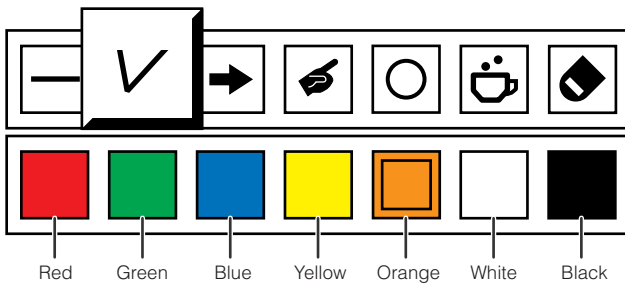

Projector

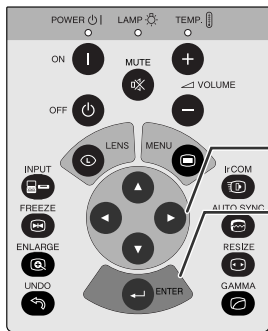

Remote control

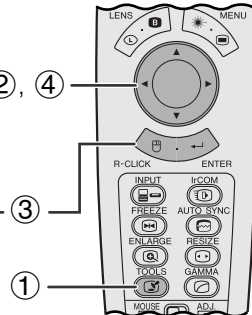

This projector is equipped with presentation tools. These will help you emphasize keypoints within your presentation.

(Slide the **MOUSE/ADJUSTMENT** switch on the remote control to the ADJ. position.)



- ① Press **TOOLS** to display the presentation tools menu window on the screen.
- ② Press **▲/▼/◀/▶** to select the desired tool and color.
- ③ Press **ENTER** to select it.
- ④ Once the tool is displayed on the screen, press **▲/▼/◀/▶** to move it around the screen.
- ⑤ Press **ENTER** to stamp the tool on the screen.
- ⑥ Use **UNDO** to individually delete tools stamped on the screen.

NOTE

- You can stamp each tool as many times as you want on the screen.
- To clear all the stamped presentation tools on the screen, press **▲/▼/◀/▶** to select "☒" and **ENTER**.

Displaying the break time

(Slide the **MOUSE/ADJUSTMENT** switch on the remote control to the ADJ. position.)

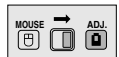

- ① Press **TOOLS** to display the presentation tools menu window on the screen.
- ② Press **▲/▼/◀/▶** to select "☒" in the menu window.
- ③ Press **ENTER** to start counting down the break time.
- ④ Press **▲** to increase or **▼** to decrease the break time.

NOTE

- The break time is displayed against the background image selected in "Selecting a Startup Image". (See page 41.)

When selecting Sharp default image





Status Function

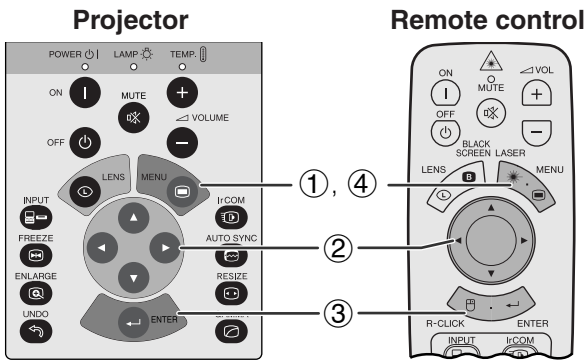

This function can be used to display all the adjusted settings on the screen simultaneously.

(Slide the **MOUSE/ADJUSTMENT** switch on the remote control to the ADJ. position.)



- ① Press **MENU**.
- ② Press ◀/▶ to select "Status".
- ③ Press **ENTER** to display all the adjusted settings.
- ④ To exit from the GUI, press **MENU**.

(GUI) On-screen Display

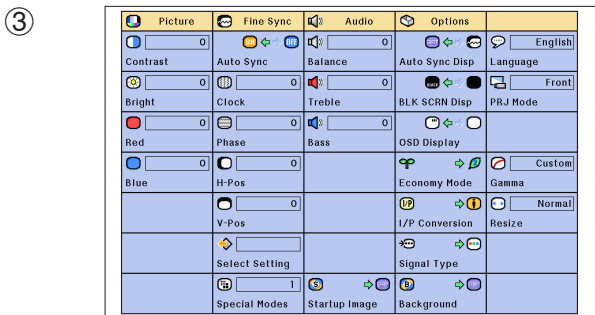
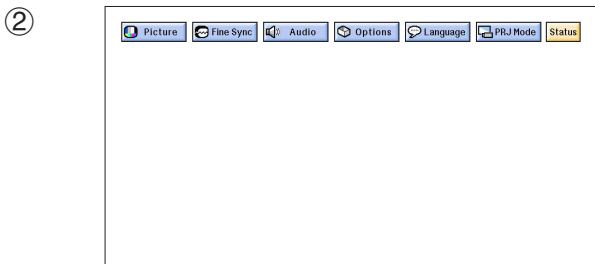



Maintenance & Troubleshooting

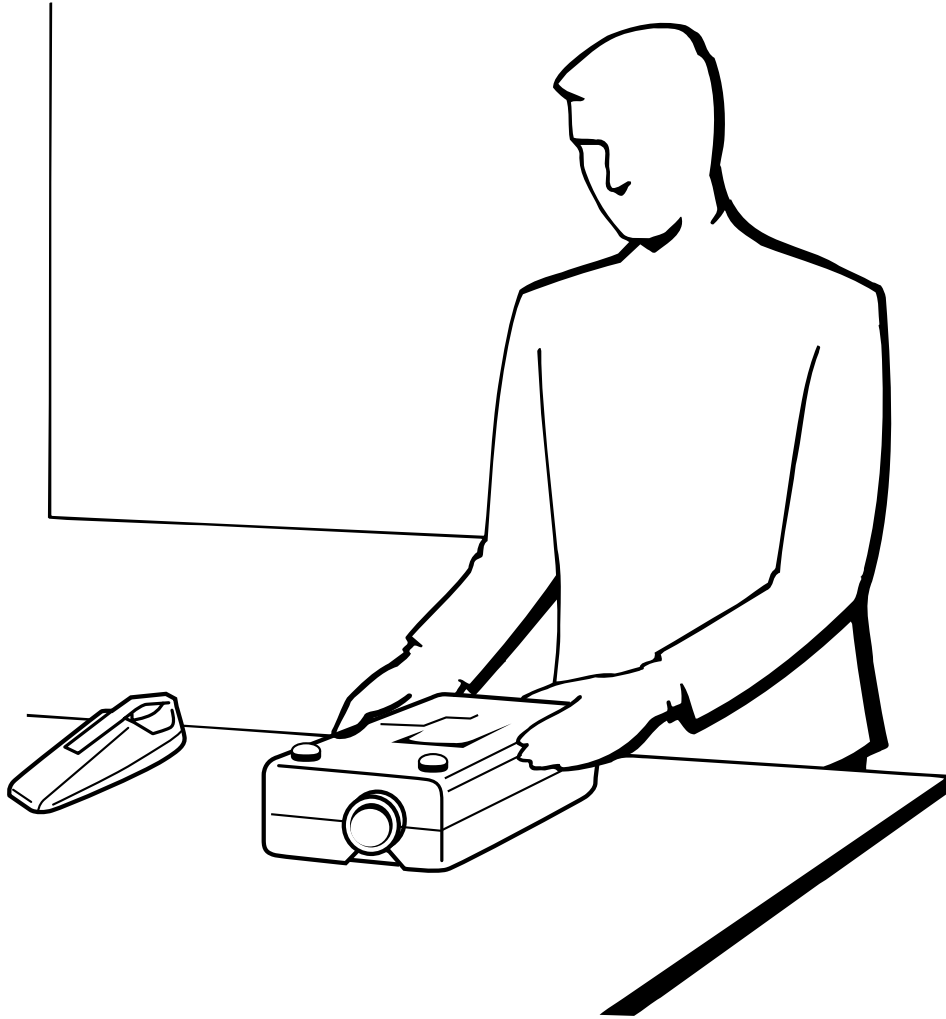



Air Filter Maintenance

- This projector is equipped with two air filters to ensure the optimal operating condition of the projector.
- The air filters should be cleaned every 100 hours of use. Clean the filters more often when the projector is used in a dusty or smoky location.
- Have your nearest Authorized Sharp Industrial LCD Products Dealer or Service Center exchange the filter (PFILD0080CEZZ) when it is no longer possible to clean it.

Bottom View

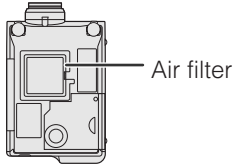

Side and Rear View

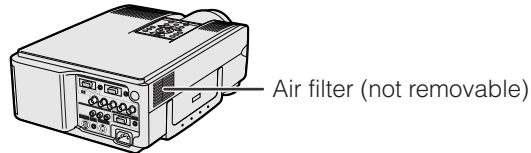

Cleaning and replacing the bottom air filter

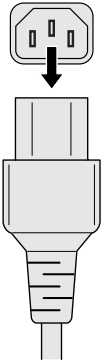
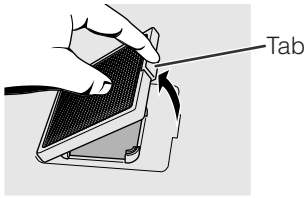
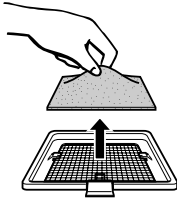
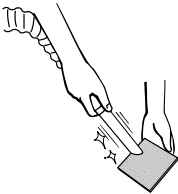
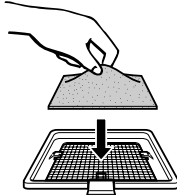
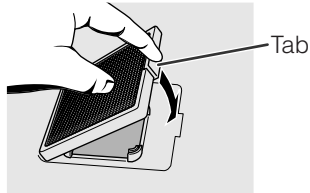
<p>1 Unplug the power cord.</p>	<p>2 Remove the bottom filter cover.</p>	<p>3 Remove the air filter.</p>
	<p>Turn over the projector. Press the tab and lift open the filter cover in the direction of the arrow.</p>  <p>Tab</p>	<p>Grasp the air filter between your fingers and lift it out of the filter cover.</p> 
<p>4 Clean the air filter.</p>	<p>5 Replace the air filter.</p>	<p>6 Replace the filter cover.</p>
<p>Clean the dust off the air filter and cover with a vacuum cleaner extension hose.</p> 	<p>Place the air filter underneath the tabs on the filter frame.</p> 	<p>Insert the tab on the end of the filter cover into the filter cover opening and press the filter cover into position.</p>  <p>Tab</p>

NOTE

- Be sure the filter cover is securely installed. The power will not turn on unless it is correctly installed.

Cleaning the side air filter (not removable)

If dust or dirt has collected inside the air filter, clean the filter with a vacuum cleaner extension hose.

NOTE

- The side air filter cannot be removed.





Lamp/Maintenance Indicators

Maintenance Indicators

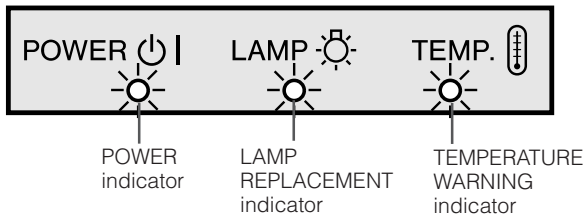

- The warning lights on the projector indicate problems inside the projector.
- There are two warning lights: a TEMPERATURE WARNING indicator which warns that the projector is too hot, and a LAMP REPLACEMENT indicator which lets you know when to change the lamp.
- If a problem occurs, either the TEMPERATURE WARNING indicator or the LAMP REPLACEMENT indicator will light up red. After turning off the power, follow the procedures given below.

Maintenance Indicator	Condition	Problem	Possible Solution
TEMPERATURE WARNING indicator	The internal temperature is abnormally high.	• Blocked air intake.	• Relocate the projector to an area with proper ventilation.
		• Clogged air filter.	• Clean the filter. (See page 46.)
		• Cooling fan breakdown. • Internal circuit failure.	• Take the projector to your nearest Authorized Sharp Industrial LCD Products Dealer or Service Center for repair.
LAMP REPLACEMENT indicator	The lamp does not light up.	• Burnt-out lamp. • Lamp circuit failure.	• Carefully replace the lamp. (See pages 48 and 49.) • Take the projector to your nearest Authorized Sharp Industrial LCD Products Dealer or Service Center for repair.
POWER indicator	The POWER indicator flashes in red when the projector is on.	• The bottom filter cover is open.	• Securely install the bottom filter cover.

NOTE

- If the TEMPERATURE WARNING indicator lights up, follow the above possible solutions and then wait until the projector has cooled down completely before turning the power back on. (At least 5 minutes.)
- If the power is turned off and then turned on again, as during a brief rest, the LAMP REPLACEMENT indicator may be triggered, preventing the power from going on. Should this occur, take the power cord out of the wall outlet and put it back in again.

Lamp

The lamp in this projector operates for approximately 2,000 cumulative hours, depending on the usage environment. It is recommended that the lamp be replaced after 1,900 cumulative hours of use or when you notice a significant deterioration of the picture and color quality. The lamp usage time can be checked with the On-screen Display (see page 39).

CAUTION

- Intense light hazard. Do not attempt to look into the aperture and lens while the projector is operating.

NOTE

- As the usage environment can vary significantly, the projector lamp may not operate for 2,000 hours.





Replacing the Projection Lamp

It is recommended that the lamp be replaced after approximately 2,000 cumulative hours of use or when you notice a significant deterioration of the picture and color quality. Carefully change the lamp by following the steps below.

If the new lamp does not light after replacement, take your projector to the nearest Authorized Sharp Industrial LCD Products Dealer or Service Center for repair. Purchase a replacement lamp unit (lamp/cage module) of the current type BQC-XGNV6XU/1 from your nearest Authorized Sharp Industrial LCD Products Dealer or Service Center. Then carefully change the lamp by following the instructions below. If you wish, you may have the lamp replaced at your nearest Authorized Sharp Industrial LCD Products Dealer or Service Center.

IMPORTANT NOTE TO U.S. CUSTOMERS:

The lamp included with this projector is backed by a 90-day parts and labor limited warranty. All service of this projector under warranty, including lamp replacement, must be obtained through an Authorized Sharp Industrial LCD Products Dealer or Service Center. For the name of the nearest Authorized Sharp Industrial LCD Products Dealer or Service Center, please call toll-free: 1-800-BE-SHARP (1-800-237-4277).

U.S.A. ONLY

Removing and installing the lamp unit

CAUTION

- Do not remove the lamp cage directly after operation of the projector. The lamp may be extremely hot. Wait at least one hour after the power cord is disconnected to allow the surface of the lamp cage to fully cool before removing the lamp cage.
- Be sure to remove the lamp cage by the handle. Be sure not to touch the glass surface of the lamp cage or the inside of the projector.
- To avoid injury to yourself and damage to the lamp, be sure to carefully follow the steps below.
- Before or after replacing the lamp, be sure to clean the air filters. See page 46 for cleaning the air filters.

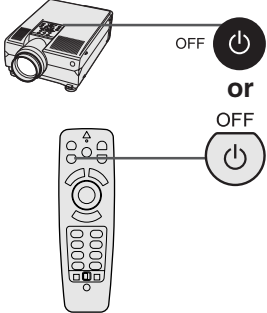
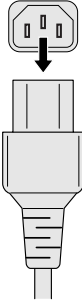
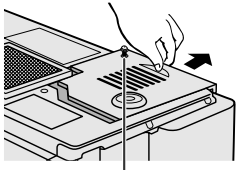
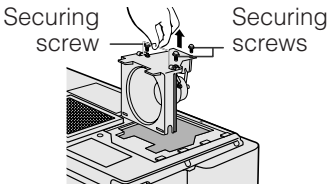
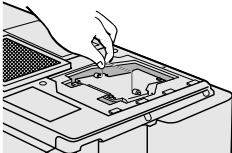
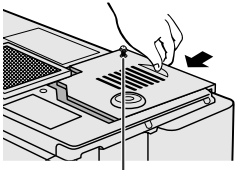

<p>1 Turn off the power.</p> <p>Press POWER OFF. Wait until the cooling fan stops.</p> 	<p>2 Disconnect the power cord.</p> <p>Unplug the power cord from the AC socket.</p> 	<p>3 Slide the lamp cage cover out.</p> <p>Turn over the projector and unfasten the user service screw that secures the lamp cage cover. Then slide the cover in the direction of the arrow.</p>  <p>User service screw</p>
<p>4 Remove the lamp cage.</p> <p>Remove the securing screws from the lamp cage. Hold the lamp cage by the handle and pull it towards you.</p>  <p>Securing screw Securing screws</p>	<p>5 Replace the lamp cage (after changing the lamp).</p> <p>Press the lamp cage firmly into the lamp cage compartment. Fasten the securing screws.</p> 	<p>6 Slide the lamp cage cover in.</p> <p>Slide the lamp cage cover in the direction of the arrow. Then fasten the user service screw.</p>  <p>User service screw</p>



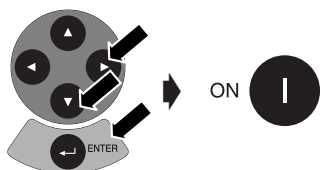

Replacing the Projection Lamp

Resetting the lamp timer

<p>1 Connect the power cord.</p> <p>Plug the power cord into the AC socket of the projector.</p> 	<p>2 Reset the lamp timer.</p> <p>While pressing ▼, ▶ and ENTER on the projector, press POWER ON on the projector.</p> 	<p>"LAMP 0000H" is displayed, indicating that the lamp timer is reset.</p> 
---	---	--

NOTE

- Reset the lamp timer only after replacing the lamp.



Using the Kensington Lock

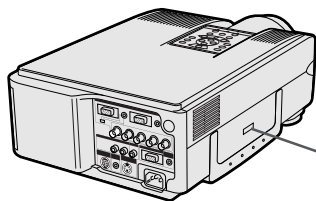

Kensington Security Standard connector

This projector has a Kensington Security Standard connector for use with a Kensington MicroSaver Security System. Refer to the information that came with the system for instructions on how to use it to secure the projector.



Troubleshooting

Problem	Check
No picture and no sound.	<ul style="list-style-type: none"> Projector power cord is not plugged into the wall outlet. The bottom filter cover is not securely installed. Selected input is wrong. (See page 17.) Cables improperly connected to rear panel of the projector. (See pages 11–15.) Remote control batteries have run down. (See page 8.) Remote control's MOUSE/ADJUSTMENT switch is set to MOUSE.
Sound is heard but no picture appears.	<ul style="list-style-type: none"> Cables improperly connected to rear panel of the projector. (See pages 11–15.) "Contrast" and "Bright" adjustments are set to minimum position. (See page 27.) On-screen Display ("BLACK SCREEN") is turned off and Black Screen function is turned on, creating a black image. (See page 37.)
Color is faded or poor.	<ul style="list-style-type: none"> "Color" and "Tint" adjustments are not correct. (See page 27.)
Picture is blurred.	<ul style="list-style-type: none"> Adjust the focus. (See page 19.) Projection distance is too long or too short to allow for proper focus. (See page 18.)
Picture appears but no sound is heard.	<ul style="list-style-type: none"> Cables improperly connected to rear panel of the projector. (See pages 11–15.) Volume is set to minimum. (See page 17.)
An unusual sound is occasionally heard from the cabinet.	<ul style="list-style-type: none"> If the picture is normal, the sound is due to cabinet shrinkage caused by temperature changes. This will not affect operation or performance.
Maintenance indicator lights up.	<ul style="list-style-type: none"> Refer to "Lamp/Maintenance Indicators" on page 47.
Data cannot be received via IrCOM.	<ul style="list-style-type: none"> Distance and angle between the projector and transmitting device are out of the designated range. (See page 25.) Refer to the operation manual of the transmitting device. Refer to the section "Troubleshooting" in the operation manual of the supplied software.
Picture noise appears.	<ul style="list-style-type: none"> Adjust the phase setting. (See page 29.) Noise may appear when used with certain computers. Set the NOISE FILTER to ON using the RS-232C command. (See pages 52 and 53.)
480P images do not appear.	<ul style="list-style-type: none"> Set the resolution mode to 480P. (See page 32.)
Color is distorted (except for VIDEO mode).	<ul style="list-style-type: none"> Change the input signal type. (See page 40.)
Lens comes off.	<ul style="list-style-type: none"> Align the mark on the lens with the corresponding mark on the projector, push the lens firmly in place, and rotate to the right.





Appendix

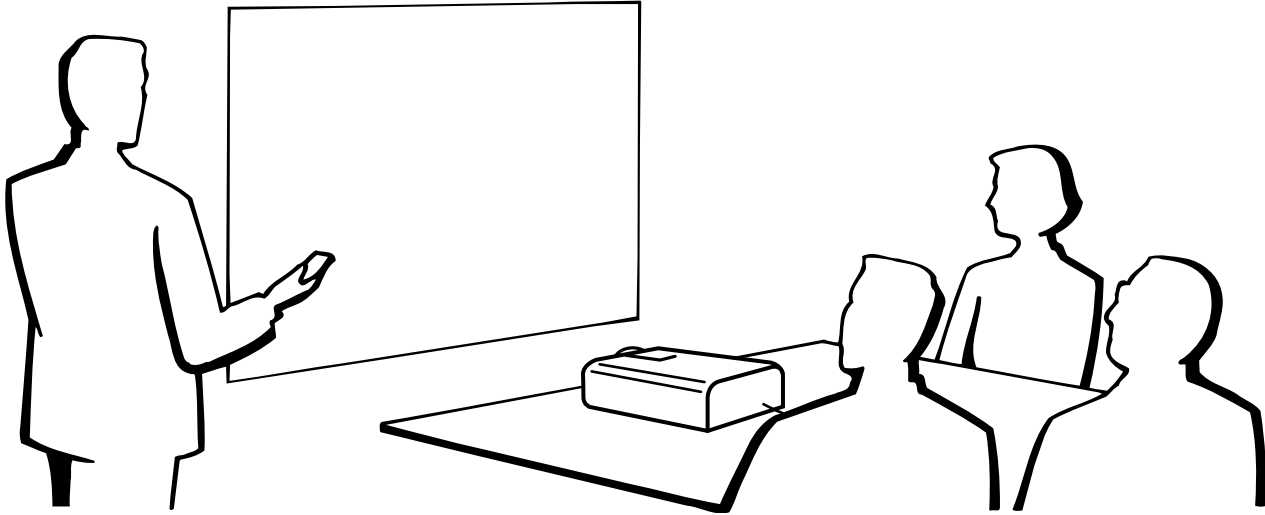

Optional Lenses

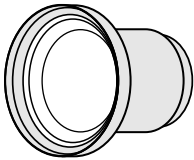

Wide-zoom lens
AN-W6EZ

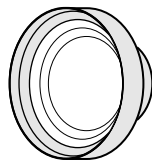

Tele-zoom lens
AN-T6EZ

Optional wide and telephoto lenses from Sharp are also available for specialized application. Please see your local Sharp Industrial LCD Products Dealer for details on the AN-W6EZ and AN-T6EZ. (Refer to the lens operation manual when attaching the lens.)

100" Screen Project Distance

8'6"-11'2" (2.6-3.4 m)

AN-W6EZ

12'-15'11" (3.65-4.86 m)

Standard lens

16'5"-21'6" (5-6.56 m)

AN-T6EZ

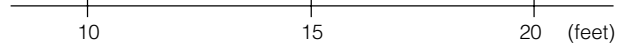

Transporting the Projector

Using the Carrying Handle

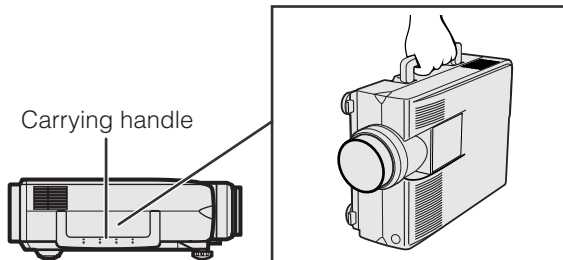

When transporting the projector, carry it by the carrying handle on the side.

CAUTION

- Always put on the lens cap to prevent damage to the lens when transporting the projector.
- Do not lift or carry the projector by the lens or the lens cap as this may damage the lens.





Connection Pin Assignments

Analog Computer 1 and 2 Signal Input Ports: 15-pin mini D-sub female connector

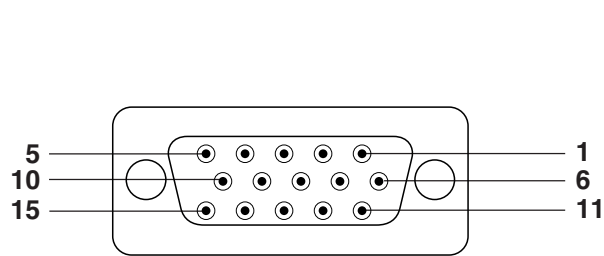

Computer Input

Analog

- | | |
|--------------------------------------|----------------------------|
| 1. Video input (red) | 9. Not connected |
| 2. Video input (green/sync on green) | 10. GND |
| 3. Video input (blue) | 11. GND |
| 4. Reserve input 1 | 12. Bi-directional data |
| 5. Composite sync | 13. Horizontal sync signal |
| 6. Earth (red) | 14. Vertical sync signal |
| 7. Earth (green/sync on green) | 15. Data clock |
| 8. Earth (blue) | |

RS-232C Port: 9-pin D-sub male connector of the DIN-D-sub RS-232C cable

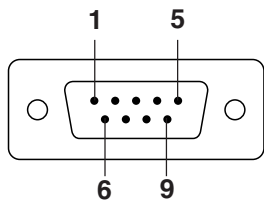

Pin No.	Signal	Name	I/O	Reference
1	CD			Not connected
2	RD	Receive Data	Input	Connected to internal circuit
3	SD	Send Data	Output	Connected to internal circuit
4	ER			Not connected
5	SG	Signal Ground		Connected to internal circuit
6	DR	Data Set Ready	Output	Not connected
7	RS	Request to Send	Output	Connected to internal circuit
8	CS	Clear to Send	Input	Connected to internal circuit
9	CI			Not connected

RS-232C Terminal: 9-pin Mini DIN connector

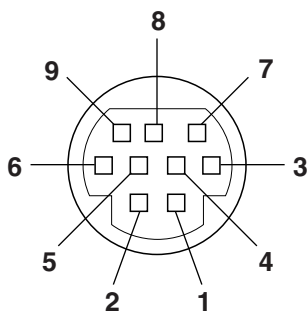

Pin No.	Signal	Name	I/O	Reference
1	VCC	+ 3.3V (Reserved)	Output	Not connected
2	RD	Receive Data	Input	Connected to internal circuit
3	SD	Send Data	Output	Connected to internal circuit
4	EXIR	Detector of Option Unit (Reserved)	Input	Not connected
5	SG	Signal Ground		Connected to internal circuit
6	ERX	IR Receive Signal from IR Amplifire (Reserved)	Input	Not connected
7	RS	Request to Send	Output	Connected to internal circuit
8	CS	Clear to Send	Input	Connected to internal circuit
9	ETX	IR Transmit Signal (Reserved)	Output	Not connected





RS-232C Port Specifications

PC control

A computer can be used to control the projector by connecting an RS-232C cable (cross type, sold separately) to the projector. (See page 14 for connection.)

Communication conditions

Set the serial port settings of the computer to match that of the table.

Signal format: Conforms to RS-232C standard.

Baud rate: 9,600 bps

Data length: 8 bits

Parity bit: NON

Stop bit: 1 bit

Flow control: None

Basic format

Commands from the computer are sent in the following order: command, parameter, and return code. After the projector processes the command from the computer, it sends a response code to the computer.

Command format

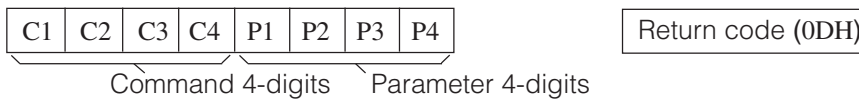

Response code format

Normal response



Problem response (communication error or incorrect command)



When more than one code is being sent, send each command only after the OK response code for the previous command from the projector is verified.

NOTE

- When using the computer control function of the projector, the projector operating status cannot be read to the computer. Therefore, confirm the status by transmitting the display commands for each adjustment menu and checking the status with the On-screen Display. If the projector receives a command other than a menu display command, it will execute the command without displaying the On-screen Display.

Commands

EXAMPLE

- When "BRIGHT" of INPUT 1 IMAGE ADJUSTMENT is set to -10.

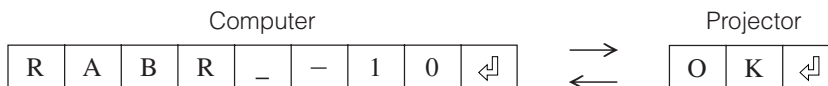

CONTROL ITEM	COMMAND				PARAMETER				CONTROL CONTENTS
	C1	C2	C3	C4	P1	P2	P3	P4	
AUTO POWER OFF	A	P	O	W	_	_	_	0	AUTO POWER OFF
	A	P	O	W	_	_	_	1	AUTO POWER ON
POWER SETTING	P	O	W	R	_	_	_	0	POWER OFF (STANDBY)
	P	O	W	R	_	_	_	1	POWER ON
INPUT SWITCHING	I	V	E	D	_	_	_	1	VIDEO
	I	R	G	B	_	_	_	1	INPUT1
	I	R	G	B	_	_	_	2	INPUT2
	I	C	O	M	_	_	_	1	IrCOM1
	I	C	O	M	_	_	_	2	IrCOM2
INPUT CHECK	I	C	H	K	_	_	_	0	INPUT CHECK
LENS ADJUSTMENT	L	N	F	O	_	*	*	*	LENS FOCUS (-30 - +30)
	L	N	Z	O	_	*	*	*	LENS ZOOM (-30 - +30)
	K	E	Y	S	*	*	*	*	KEystone (-127 - +127)

CONTROL ITEM	COMMAND				PARAMETER				CONTROL CONTENTS
	C1	C2	C3	C4	P1	P2	P3	P4	
LANGUAGE SELECTION	M	E	L	A	_	_	_	1	ENGLISH
	M	E	L	A	_	_	_	2	DEUTSCH
	M	E	L	A	_	_	_	3	ESPAÑOL
	M	E	L	A	_	_	_	4	NEDERLANDS
	M	E	L	A	_	_	_	5	FRANÇAIS
	M	E	L	A	_	_	_	6	ITALIANO
	M	E	L	A	_	_	_	7	SVENSKA
	M	E	L	A	_	_	_	8	日本語
	M	E	L	A	_	_	_	9	PORTUGUÉS
	M	E	L	A	_	_	1	0	汉语
M	E	L	A	_	_	1	1	한국어	





RS-232C Port Specifications

CONTROL ITEM	COMMAND				PARAMETER				CONTROL CONTENTS
	C1	C2	C3	C4	P1	P2	P3	P4	
VIDEO SYSTEM SELECTION	M	E	S	Y	_	_	_	1	AUTO
	M	E	S	Y	_	_	_	2	PAL (50/60 Hz)
	M	E	S	Y	_	_	_	3	SECAM
	M	E	S	Y	_	_	_	4	NTSC 4.43
	M	E	S	Y	_	_	_	5	NTSC 3.58
VIDEO IMAGE ADJUSTMENT	V	A	P	I	_	*	*	*	CONTRAST (-30 - +30)
	V	A	B	R	_	*	*	*	BRIGHT (-30 - +30)
	V	A	C	O	_	*	*	*	COLOR (-30 - +30)
	V	A	T	I	_	*	*	*	TINT (-30 - +30)
	V	A	S	H	_	*	*	*	SHARPNESS (-30 - +30)
	V	A	R	E	_	_	_	1	RESET
	V	A	R	D	_	*	*	*	RED (-30 - +30)
	V	A	B	E	_	*	*	*	BLUE (-30 - +30)
	V	A	R	E	_	_	_	0	VIDEO DISPLAY
	V	A	R	E	_	_	_	1	RESET
BACKGROUND SELECTION	I	M	B	G	_	_	_	1	SHARP
	I	M	B	G	_	_	_	2	CUSTOM
	I	M	B	G	_	_	_	3	BLUE
STARTUP IMAGE SELECTION	I	M	S	I	_	_	_	1	SHARP
	I	M	S	I	_	_	_	2	CUSTOM
	I	M	S	I	_	_	_	3	NONE
VOLUME ADJUSTMENT	V	O	L	A	_	_	*	*	VOLUME (00 - 60)
	M	U	T	E	_	_	_	0	MUTE OFF
	M	U	T	E	_	_	_	1	MUTE ON
AUDIO ADJUSTMENT	A	A	B	L	_	*	*	*	BALANCE (-30 - +30)
	A	A	T	E	_	*	*	*	TREBLE (-30 - +30)
	A	A	B	A	_	*	*	*	BASS (-30 - +30)
	A	A	R	E	_	_	_	0	AUDIO DISPLAY
	A	A	R	E	_	_	_	1	RESET
INPUT 1 IMAGE ADJUSTMENT	R	A	P	I	_	*	*	*	CONTRAST (-30 - +30)
	R	A	B	R	_	*	*	*	BRIGHT (-30 - +30)
	R	A	R	D	_	*	*	*	RED (-30 - +30)
	R	A	B	E	_	*	*	*	BLUE (-30 - +30)
	R	A	R	E	_	_	_	0	INPUT 1 DISPLAY
	R	A	C	O	_	*	*	*	COLOR (-30 - +30)
	R	A	T	I	_	*	*	*	TINT (-30 - +30)
	R	A	S	H	_	*	*	*	SHARPNESS (-30 - +30)
INPUT 2 IMAGE ADJUSTMENT	R	B	P	I	_	*	*	*	CONTRAST (-30 - +30)
	R	B	B	R	_	*	*	*	BRIGHT (-30 - +30)
	R	B	R	D	_	*	*	*	RED (-30 - +30)
	R	B	B	E	_	*	*	*	BLUE (-30 - +30)
	R	B	R	E	_	_	_	0	INPUT 2 DISPLAY
	R	B	C	O	_	*	*	*	COLOR (-30 - +30)
	R	B	T	I	_	*	*	*	TINT (-30 - +30)
	R	B	S	H	_	*	*	*	SHARPNESS (-30 - +30)
	R	B	R	E	_	_	_	1	RESET
	INPUT AUTO SYNCHRONIZATION	A	A	D	J	_	_	_	0
A		A	D	J	_	_	_	1	AUTO SYNC ON
A		D	J	S	_	_	_	1	AUTO SYNC START

CONTROL ITEM	COMMAND				PARAMETER				CONTROL CONTENTS	
	C1	C2	C3	C4	P1	P2	P3	P4		
INPUT ADJUSTMENT	I	N	C	L	*	*	*	*	CLOCK (-150 - +150)	
	I	N	P	H	_	*	*	*	PHASE (-60 - +60)	
	I	A	H	P	*	*	*	*	H-POS (-150 - +150)	
	I	A	V	P	_	*	*	*	V-POS (-60 - +60)	
	I	A	R	E	_	_	_	0	COMPUTER INPUT DISPLAY	
	I	A	R	E	_	_	_	1	RESET	
	SCREEN SETTING	I	M	D	I	_	_	_	0	OSD DISPLAY OFF
I		M	D	I	_	_	_	1	OSD DISPLAY ON	
I		M	R	E	_	_	_	0	REVERSE OFF	
I		M	R	E	_	_	_	1	REVERSE ON	
I		M	I	N	_	_	_	0	INVERT OFF	
I		M	I	N	_	_	_	1	INVERT ON	
I		M	A	S	_	_	_	0	AUTO SYNC DISPLAY OFF	
I		M	A	S	_	_	_	1	AUTO SYNC DISPLAY ON	
I		M	I	P	_	_	_	0	I/P CONVERSION INTERLACED	
I		M	I	P	_	_	_	1	I/P CONVERSION PROGRESSIVE	
INPUT1 SIGNAL TYPE SELECTION		I	A	S	I	_	_	_	1	RGB
		I	A	S	I	_	_	_	2	COMPONENT
INPUT2 SIGNAL TYPE SELECTION		I	B	S	I	_	_	_	1	RGB
	I	B	S	I	_	_	_	2	COMPONENT	
INPUT GAMMA SELECTION	G	A	M	R	_	_	_	1	STANDARD	
	G	A	M	R	_	_	_	2	GAMMA1	
	G	A	M	R	_	_	_	3	GAMMA2	
	G	A	M	R	_	_	_	4	CUSTOM	
VIDEO GAMMA SELECTION	G	A	M	V	_	_	_	1	STANDARD	
	G	A	M	V	_	_	_	2	GAMMA1	
	G	A	M	V	_	_	_	3	GAMMA2	
	G	A	M	V	_	_	_	4	CUSTOM	
VIDEO CONFIRMATION	S	Y	S	E	_	_	_	0	DISPLAY	
BLACK SCREEN	I	M	B	K	_	_	_	0	BLACK SCREEN OFF	
	I	M	B	K	_	_	_	1	BLACK SCREEN ON	
	I	M	B	O	_	_	_	0	BLACK SCREEN DISPLAY OFF	
	I	M	B	O	_	_	_	1	BLACK SCREEN DISPLAY ON	
SCREEN MODE MEMORY	M	E	M	S	_	_	_	*	SAVE SETTING (1-7)	
	M	E	M	L	_	_	_	*	SELECT SETTING (1-7)	
INPUT1 RESIZE	R	A	S	R	_	_	_	1	NORMAL	
	R	A	S	R	_	_	_	2	WIDE/FIT TO SCREEN	
	R	A	S	R	_	_	_	3	DOT BY DOT	
	R	A	S	R	_	_	_	4	DOT BY DOT (WIDE)	
INPUT2 RESIZE	R	B	S	R	_	_	_	1	NORMAL	
	R	B	S	R	_	_	_	2	WIDE/FIT TO SCREEN	
	R	B	S	R	_	_	_	3	DOT BY DOT	
	R	B	S	R	_	_	_	4	DOT BY DOT (WIDE)	
VIDEO RESIZE	R	A	S	V	_	_	_	1	NORMAL	
	R	A	S	V	_	_	_	2	WIDE	
	R	A	S	V	_	_	_	3	DOT BY DOT	
NOISE FILTER	N	F	I	L	_	_	_	0	FILTER OFF	
	N	F	I	L	_	_	_	1	FILTER ON	

NOTE

- If a dash (_) appears in the parameter column, enter a space. If an asterisk (*) appears, enter a value in the range indicated in brackets under CONTROL CONTENTS.
- INPUT ADJUSTMENT can only be set in the displayed computer mode.
- Noise may appear when used with certain computers. Set the NOISE FILTER to ON using the RS-232C command.



Wired Remote Control Terminal Specifications

Specifications of wired remote control input

- $\varnothing 3.5$ mm minijack
- External: +5 V (1 A)
- Internal: GND

Function and transmission codes

No.	Control Item (Function)	System Code					Data Code					External Code						
		C1	C2	C3	C4	C5	C6	C7	C8	C9	C10	C11	C12	C13	C14	C15		
1	POWER ON	1	0	1	1	0	0	1	1	0	1	0	1	0	1	0	1	0
2	POWER OFF	1	0	1	1	0	0	1	1	0	1	0	0	1	1	0	1	0
3	VOLUME -	1	0	1	1	0	1	0	1	0	1	0	0	0	1	0	1	0
4	VOLUME +	1	0	1	1	0	0	0	1	0	1	0	0	0	1	0	1	0
5	MUTE	1	0	1	1	0	1	1	1	0	1	0	0	0	0	1	0	1
6	MENU	1	0	1	1	0	0	0	1	0	0	0	1	1	1	0	1	0
7	LENS	1	0	1	1	0	1	1	0	1	0	0	0	1	1	0	1	0
8	TOOLS	1	0	1	1	0	0	1	0	1	0	1	1	1	1	0	1	0
9	BLACK SCREEN	1	0	1	1	0	1	0	0	1	0	1	1	0	1	0	1	0
10	ENTER	1	0	1	1	0	1	1	1	0	1	0	1	0	1	0	1	0
11	UNDO	1	0	1	1	0	1	0	0	1	1	0	1	0	1	0	1	0

No.	Control Item (Function)	System Code					Data Code					External Code							
		C1	C2	C3	C4	C5	C6	C7	C8	C9	C10	C11	C12	C13	C14	C15			
12	IrCOM	1	0	1	1	0	1	1	1	0	1	1	0	1	1	0	1	1	0
13	INPUT	1	0	1	1	0	1	1	0	0	1	0	0	0	1	0	0	1	0
14	FREEZE	1	0	1	1	0	1	0	1	1	0	0	0	0	1	1	0	1	0
15	ENLARGE	1	0	1	1	0	1	0	1	1	0	1	1	0	1	1	0	1	0
16	AUTO SYNC	1	0	1	1	0	0	1	0	1	1	1	1	1	1	1	1	1	0
17	ADJUST ▲	1	0	1	1	0	0	0	1	1	1	1	0	0	1	1	0	1	0
18	ADJUST ▼	1	0	1	1	0	1	0	1	1	1	1	0	0	1	1	0	1	0
19	ADJUST ◀	1	0	1	1	0	0	0	0	0	1	0	1	0	1	0	1	0	0
20	ADJUST ▶	1	0	1	1	0	1	1	1	1	1	0	0	1	0	1	0	1	0
21	RESIZE	1	0	1	1	0	0	1	1	1	1	1	0	1	0	1	0	1	0
22	GAMMA	1	0	1	1	0	0	0	0	0	0	0	0	1	0	1	0	1	0

NOTE

- To operate the mouse, left-click and right-click functions through the wired remote control input, connect the cable from the WIRED REMOTE control input terminal on the projector to the remote control. The codes for these functions are complex and are, therefore, not listed here.

Wired remote control function code

LSB

MSB

C1	System Code				C5	C6	Data Code					C13	C14	C15	
1	0	1	1	0	1	0	*	*	*	*	*	*	*	1	0

- System codes C1 to C5 are fixed at "10110".
- Codes C14 and C15 are reverse confirmation bits, with "10" indicating "Front" and "01" indicating "Rear".

Sharp remote control signal format

Transmission format: 15-bit format

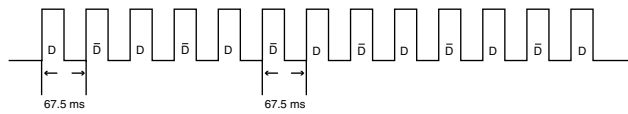

Wave form of output signal: Output using Pulse Position Modulation

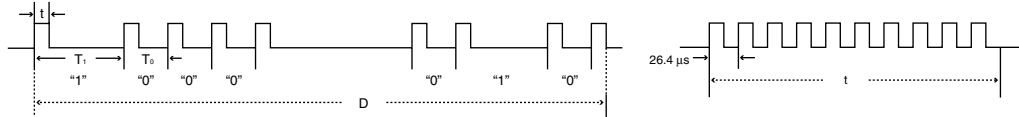

- $t = 264 \mu s$
- $T_0 = 1.05 ms$
- $T_1 = 2.10 ms$
- Pulse carrier frequency = 455/12 kHz
- Duty ratio = 1:1

Transmission control code

15 bit

C1	C2	C3	C4	C5	C6	C7	C8	C9	C10	C11	C12	C13	C14	C15
System Address					Function Key Data Bit					Data Expansion	Mask	Data Determination		
D to \bar{D} Common Data Bit					Reverse in \bar{D}									

Example of Reverse D to \bar{D}

D	C1	C2	C3	C4	C5	C6	C7	C8	C9	C10	C11	C12	C13	C14	C15
1	0	1	1	0	1	0	0	0	0	0	0	0	0	1	0
D	C1	C2	C3	C4	C5	C6	C7	C8	C9	C10	C11	C12	C13	C14	C15
1	0	1	1	0	0	1	1	1	1	1	1	1	1	0	1





Input Signals (Recommended Timing)

The computer output signal timing of different types of computer signals are shown below for reference.

For IBM and compatibles

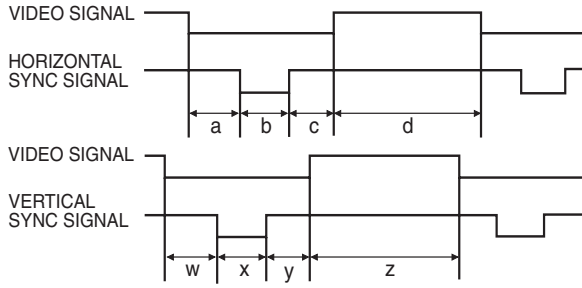

For Macintosh Series

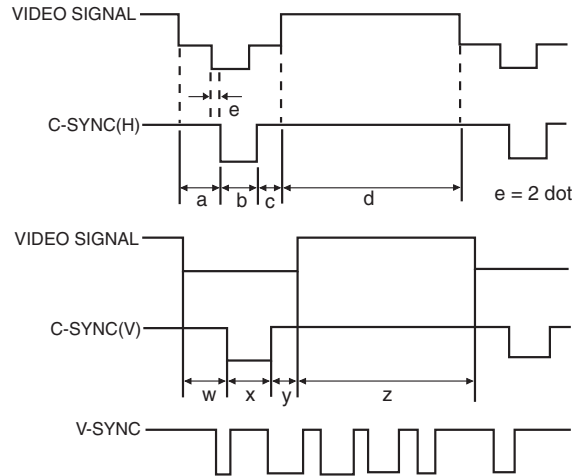

The following is a list of compatible VESA standards. Please note that this projector also accepts signals outside of the VESA standards.

NOTE

- Depending on the mode selected, the projector may clearly display images under 130 Hz.

	MODE	VIDEO		HSYNC										VSYNC									
				FRONT PORCH	SYNC	BACK PORCH	VIDEO PERIOD	1H		1dot	1/H	1/dot	LEVEL	FRONT PORCH	SYNC	BACK PORCH	VIDEO PERIOD	1V		1/V	LEVEL		
				a	b	c	d	(a+b+c+d)	μ s	ns	kHz	MHz		w	x	y	z	(w+x+y+z)	ms	Hz			
VGA	VESA Standard	dot	line	LEVEL	TYPE	dot	dot	dot	dot	dot	μ s	ns	kHz	MHz		H	H	H	H	H	ms	Hz	
		640	350			32	64	96	640	832	26.4	31.7	37.861	31.500		32	3	60	350	445	11.8	85.080	
		640	400			32	64	96	640	832	26.4	31.7	37.861	31.500		1	3	41	400	445	11.8	85.080	
	Industry Standard	720	400			36	72	108	720	936	26.4	28.2	37.927	35.500		1	3	42	400	446	11.8	85.039	
		640	480			8	96	40	640	800	31.8	39.7	31.469	25.175		2	2	25	480	525	16.7	59.940	
		640	480			16	40	120	640	832	26.4	31.7	37.861	31.500		1	3	20	480	520	13.7	72.809	
		640	480			16	64	120	640	840	26.7	31.7	37.500	31.500		1	3	16	480	500	13.3	75.000	
SVGA	VESA Guidelines	800	600			24	72	128	800	1,024	28.4	27.8	35.156	36.000		1	2	22	600	625	17.8	56.250	
		800	600			40	128	88	800	1,056	26.4	25.0	37.879	40.000		1	4	23	600	628	16.6	60.317	
		800	600			56	120	64	800	1,040	20.8	20.0	48.077	50.000		37	6	23	600	666	13.9	72.188	
	VESA Standard	800	600			16	80	160	800	1,056	21.3	20.2	46.875	49.500		1	3	21	600	625	13.3	75.000	
		800	600			32	64	152	800	1,048	18.6	17.8	53.674	56.250		1	3	27	600	631	11.8	85.061	
XGA	Industry Standard	1,024	768			8	176	56	1,024	1,264	28.2	22.3	35.522	44.900		0	4	20	768	817	23.0	43.479	
	VESA Guidelines	1,024	768			24	136	160	1,024	1,344	20.7	15.4	48.363	65.000		3	6	29	768	806	16.7	60.004	
	1,024	768			24	136	144	1,024	1,328	17.7	13.3	56.476	75.000		3	6	29	768	806	14.3	70.069		
	1,024	768			16	96	176	1,024	1,312	16.7	12.7	60.023	78.750		1	3	28	768	800	13.3	75.029		
	1,024	768			48	96	208	1,024	1,376	14.6	10.6	68.677	94.500		1	3	36	768	808	11.8	84.997		
SXGA	VESA Standard	1,152	864			64	128	256	1,152	1,600	14.8	9.3	67.500	108.000		1	3	32	864	900	13.3	75.000	
		1,280	960			96	112	312	1,280	1,800	16.7	9.3	60.000	108.000		1	3	36	960	1,000	16.7	60.000	
		1,280	960			64	160	224	1,280	1,728	11.6	6.7	85.938	148.500		1	3	47	960	1,011	11.8	85.002	
		1,280	1,024			48	112	248	1,280	1,688	15.6	9.3	63.981	108.000		1	3	38	1,024	1,066	16.7	60.020	
		1,280	1,024			16	144	248	1,280	1,688	12.5	7.4	79.976	135.000		1	3	38	1,024	1,066	13.3	75.025	
		1,280	1,024			64	160	224	1,280	1,728	11.0	6.3	91.146	157.500		1	3	44	1,024	1,072	11.8	85.024	
		1,600	1,200			64	192	304	1,600	2,160	13.3	6.2	75.000	162.000		1	3	46	1,200	1,250	16.7	60.000	
UXGA	VESA Standard	1,600	1,200			64	192	304	1,600	2,160	12.3	5.7	81.250	175.500		1	3	46	1,200	1,250	15.4	65.000	
		1,600	1,200			64	192	304	1,600	2,160	11.4	5.3	87.500	189.000		1	3	46	1,200	1,250	14.3	70.000	
		1,600	1,200			64	192	304	1,600	2,160	10.7	4.9	93.750	202.500		1	3	46	1,200	1,250	13.3	75.000	
		1,600	1,200			64	192	304	1,600	2,160	9.4	4.4	106.250	229.500		1	3	46	1,200	1,250	11.8	85.000	
		1,600	1,200			64	192	304	1,600	2,160	9.4	4.4	106.250	229.500		1	3	46	1,200	1,250	11.8	85.000	



Input Signals (Recommended Timing)

	MODE		VIDEO		HSYNC									VSYNC											
					FRONT PORCH a	SYNC b	BACK PORCH c	VIDEO PERIOD d	1H (a + b + c + d)		1dot	1/H	1/dot	LEVEL	FRONT PORCH w	SYNC x	BACK PORCH y	VIDEO PERIOD z	1V (w + x + y + z)		1/V	LEVEL			
	dot	line	LEVEL	TYPE	dot	dot	dot	dot	dot	μs	ns	kHz	MHz		H	H	H	H	H	ms	Hz				
Macintosh™	13" Monitor	640	480	0.7 V _{p-p} 75 Ω load	R • G • B	64	64	96	640	864	28.6	33.1	35.000	30.2400	TTL	3	3	39	480	525	15.0	66.670	TTL		
	16" Monitor	832	624			31	65	224	832	1,152	20.1	17.5	49.693	57.246		1	3	39	624	667	13.4	74.502			
	19" Monitor	1,024	768			35	96	173	1,024	1,328	16.7	12.5	60.000	79.760		3	3	30	768	804	13.4	74.700			
	21" Monitor	1,152	870			36	128	140	1,152	1,456	14.5	10.0	68.887	100.300		3	3	39	870	915	13.3	75.287			
SUN	66Hz	1,152	900			29	128	195	1,152	1,504	14.8	10.8	61.795	92.940		2	4	31	900	937	14.3	69.950			
	76Hz	1,152	900			16	96	208	1,152	1,472	13.9	9.5	71.713	105.561		2	8	33	900	943	13.1	76.048			
	84Hz	1,152	900			24	96	168	1,024	1,312	14.1	10.8	70.838	92.940		2	8	33	800	843	11.9	84.031			
DTV	480I	640	480			R • G • B/ COMPONENT	-	-	-	-	-	-	-	15.734		-	-	-	-	-	-	-		-	59.940
	480P	640	480				-	-	-	-	-	-	-	-		31.469	-	-	-	-	-	-		-	59.940
	720P	1,280	720				-	-	-	-	-	-	-	-		44.955	-	-	-	-	-	-		-	59.740
	1080I	1,920	1,080	-	-		-	-	-	-	-	-	33.716	-	-	-	-	-	-	-	59.940				

NOTE

- This projector may not be able to display images from notebook computers in simultaneous (CRT/LCD) mode. Should this occur, turn off the LCD display on the notebook computer and output the display data in "CRT only" mode. Details on how to change display modes can be found in your notebook computer's operation manual.
- This projector can receive 640 × 350 VESA format VGA signals, however, "640 × 400" will appear on the screen.
- When receiving 1,600 × 1,200 VESA format UXGA signals, sampling occurs and the image is displayed with 1,024 lines, causing part of the image to be blocked.





Specifications

Product type	LCD Projector
Model	XG-NV6XU
Video system	PAL/SECAM/NTSC 3.58/NTSC 4.43/DTV 480P/DTV 720P/DTV 1080I
Display method	LCD panel × 3, RGB optical shutter method
LCD panel	Panel size: 1.3" (20.0 [H] × 26.6 [W] mm) Display method: Translucent TN liquid crystal panel Drive method: TFT (Thin Film Transistor) Active Matrix panel No. of dots: 786,432 dots (1,024 [H] × 768 [V])
Lens	1–1.3× zoom lens, F1.7–2.3, f = 49.1–63.8 mm
Projection lamp	150 W UHP lamp
Contrast ratio	250:1
Video input signal	RCA Connector: VIDEO, composite video, 1.0 Vp-p, sync negative, 75 Ω terminated RCA Connector: AUDIO, 0.5 Vrms more than 22 kΩ (stereo)
S-video input signal	4-pin Mini DIN connector Y (luminance signal): 1.0 Vp-p, sync negative, 75 Ω terminated C (chrominance signal): Burst 0.286 Vp-p, 75 Ω terminated
Component input signal	BNC Connector (INPUT 1) Y: 1.0 Vp-p, sync negative, 75 Ω terminated Pb: 0.7 Vp-p, 75 Ω terminated Pr: 0.7 Vp-p, 75 Ω terminated
Horizontal resolution	520 TV lines (video input), 750 TV lines (DTV 720P input, Dot by Dot)
Audio output	2 W + 2 W (stereo)
Computer RGB input signal	15-PIN MINI D-SUB CONNECTOR (INPUT 1, 2), 5 BNC CONNECTOR (INPUT 1): RGB separate/composite sync/sync on green type analog input: 0–0.7 Vp-p, positive, 75 Ω terminated STEREO MINI JACK: AUDIO, 0.5 Vrms, more than 22 kΩ (stereo) HORIZONTAL SYNC. SIGNAL: TTL level (positive/negative) or composite sync (Apple only) VERTICAL SYNC. SIGNAL: Same as above
Pixel clock	12–230 MHz
Vertical frequency	43–200 Hz
Horizontal frequency	15–126 kHz
Computer control signal	9-pin Mini DIN male connector (RS-232C Input Port)
Speaker system	1 3 ¹ / ₂ " (5 cm) round × 2
Rated voltage	AC 110–120/220–240 V
Input current	2.4 A/1.2 A
Rated frequency	50/60 Hz
Power consumption	265 W
Operating temperature	41°F to 104°F (+5°C to +40°C)
Storage temperature	–4°F to 140°F (–20°C to +60°C)
Cabinet	Plastic
I/R carrier frequency	38 kHz
Laser pointer of remote control	Wave length: 650 nm / Max. output: 1 mW / Class II Laser Product
Dimensions (approx.)	10 9 ³ / ₃₂ " (W) × 5 5 ⁵ / ₆₄ " (H) × 14 1 ¹ / ₆₄ " (D) (261 × 129 × 356 mm) (main body only) 10 9 ³ / ₃₂ " (W) × 5 3 ³ / ₄ " (H) × 16 13 ³ / ₆₄ " (D) (261 × 146 × 411.5 mm) (including adjustment feet and projecting parts)
Weight (approx.)	15.9 lbs. (7.2 kg)
Supplied accessories	Remote control, Two AA size batteries, Power cord (11' 10", 3.6 m), Computer cable (9' 10", 3 m), Three BNC-RCA adaptors, Computer audio cable (9' 10", 3 m), Mouse control serial cable (3' 3", 1 m), Mouse control cable for IBM PS/2 (3' 3", 1 m), Mouse control cable for Mac (6 45 ⁵ / ₆₄ ", 17 cm), DIN-D-sub RS-232C cable (6 45 ⁵ / ₆₄ ", 15 cm), Remote mouse receiver, Extra air filter, Lens cap (attached), CD-ROM, LCD projector operation manual, LCD projector quick reference, Sharp Advanced Presentation Software operation manual, Sharp Advanced Presentation Software quick reference, IrDA driver installation instruction sheet
Replacement parts	Standard lens unit (CLNS-0169CE01), Lamp unit (Lamp/cage module) (BQC-XGNV6XU/1), Remote control (RRMCG1518CESA), AA size batteries, Power cord (QACCU5013CEZZ), Computer cable (QCNW-5304CEZZ), BNC-RCA adaptors (QPLGJ0107GEZZ), Computer audio cable (QCNW-4870CEZZ), Mouse control serial cable (QCNW-5112CEZZ), Mouse control cable for IBM PS/2 (QCNW-5113CEZZ), Mouse control cable for Mac (QCNW-5114CEZZ), DIN-D-sub RS-232C cable (QCNW-5288CEZZ), Remote mouse receiver (RUNTK0661CEZZ), Air filter (PFILD0080CEZZ), Lens cap (PCAPH1056CESA), CD-ROM, LCD projector operation manual, LCD projector quick reference, Sharp Advanced Presentation Software operation manual, Sharp Advanced Presentation Software quick reference, IrDA driver installation instruction sheet

This SHARP projector uses LCD (Liquid Crystal Display) panels. These very sophisticated panels contain 786,432 pixels (× RGB) TFTs (Thin Film Transistors). As with any high technology electronic equipment such as large screen TVs, video systems and video cameras, there are certain acceptable tolerances that the equipment must conform to.

This unit has some inactive TFTs within acceptable tolerances which may result in illuminated or inactive dots on the picture screen. This will not affect the picture quality or the life expectancy of the unit. If you have any questions about this matter, please call toll free 1-800-BE-SHARP (1-800-237-4277). U.S.A. ONLY

Specifications are subject to change without notice.





Dimensions

Rear View

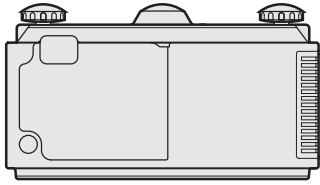

Top View

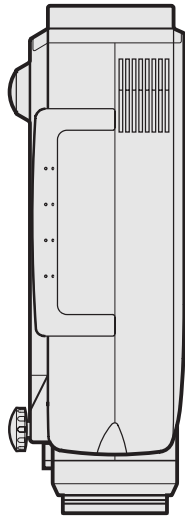
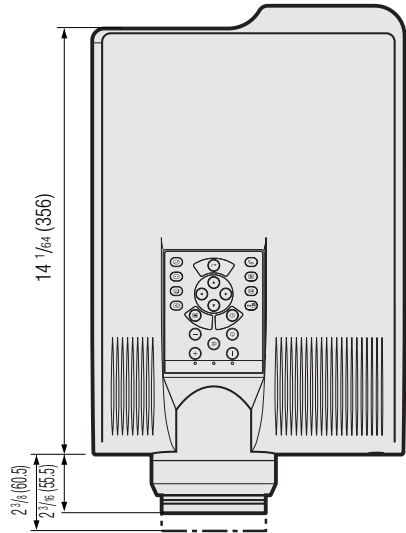

Side View

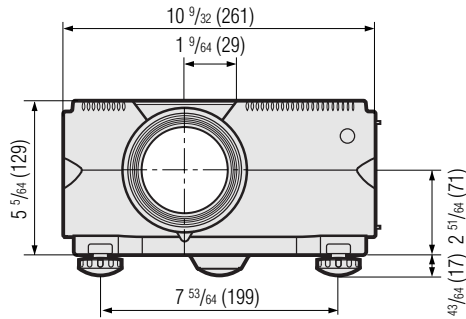
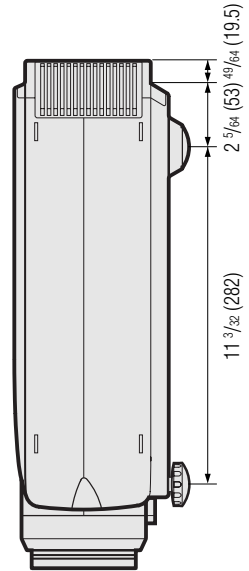

Front View

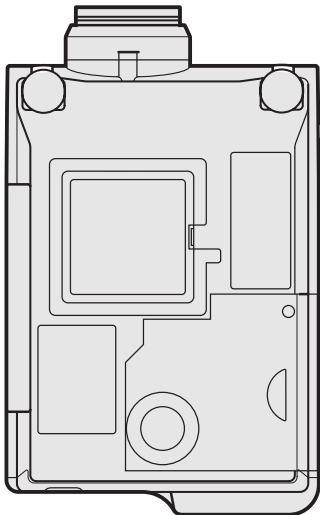

Bottom View





Guide to Effective Presentations

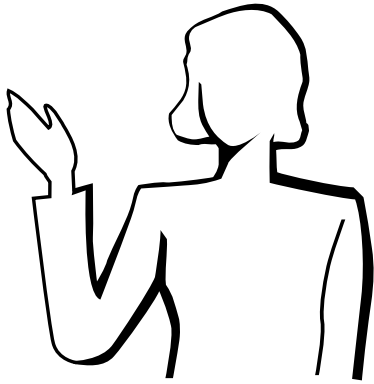

Electronic presentations are one of the most effective tools presenters can use to persuade an audience. There are several ways to enhance your presentation and maximize your effectiveness. The following are guidelines to help you create and deliver a dynamic presentation.

a. Types of Presentations

Computer Presentations

- To present basic information such as graphs, spreadsheets, documents and images, use word processing and spreadsheet applications.
- To convey more complex information and create more dynamic presentations which allow you to control the pace of your delivery, utilize software such as Astound®, Freelance®, Persuasion® or PowerPoint®.
- For high-end multimedia and interactive presentations, use software such as Macromedia Director®.

NOTE

- Astound®, Freelance®, Persuasion®, PowerPoint® and Macromedia Director® are trademarks of their respective companies.

Video Presentations

Use of video equipment, such as a VCR, DVD player and laser disc player, can be effective for delivering instructional or illustrative information that is difficult to present.

Digital Cameras and Personal Digital Assistants (PDAs)

For highly compact and portable presentations, still cameras, digital video cameras, document cameras and PDAs are ideal for transferring data without cumbersome conversions.

Multimedia Presentations

You can integrate all of the above methods for a full multimedia presentation including video, audio, computer applications and World Wide Web information.

Wireless Presentations

Use any IrDA/IrTran-P compatible source such as a laptop, digital camera or PDA to project still images quickly and effortlessly without the use of cables.

b. Creative Presentations

Oftentimes presenters do not take advantage of the many subtle ways they can manipulate their electronic slides to more effectively persuade the audience.

Color has a great effect on the audience during a presentation. When used correctly and legibly, studies show that background & foreground colors establish an emotional tone for a presentation, help viewers understand and retain information, and influence an audience to take a desired course of action.

Color Considerations

- Choose legible colors.
- Text and graphics colors need sufficient contrast.
- Use darker colors for the background since a lighter background can create uncomfortable glare. (Yellow on black creates an ideal contrast.)

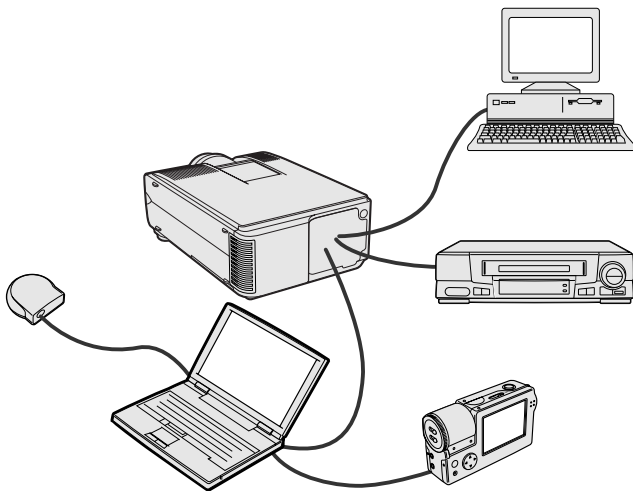
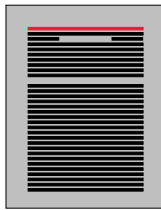
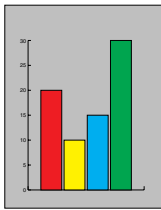

**Yellow
on Black**

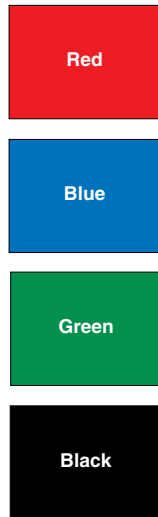

Sans-serif

Serif

- Background colors can subconsciously affect the audience:

Red—increases viewers' pulse and breathing and encourages risk taking but can also be associated with financial loss.

Blue—has a calming and conservative affect on the audience but can also create boredom among corporate audiences that are often inundated with this background color.

Green—stimulates interaction.

Black—conveys finality and certainty. Use it as a transitional color between slides when moving from one idea to another.

- Foreground colors create a major impact on how well an audience understands and remembers a message.
 - Use one or two bright colors for emphasis.
 - Highlight important messages.
- The eye has a difficult time reading certain colored text on certain colored backgrounds. For example, text and background colors in red and green, and blue and black make for difficult viewing.
- Colorblind individuals may find it difficult to distinguish between red and green, brown and green, and purple and blue. Avoid using these colors together.

Fonts

- One of the most common mistakes in any type of presentation visual is the selection of type fonts that are too small, too thin, or too difficult to read.
- If you are not sure how well a given font will read on a screen at various sizes, try this: Draw a 6" × 8" box on a piece of paper and print out several lines of text inside the box with your computer printer at 300 or 600 dpi resolution. Vary the sizes of text to simulate headline, body and text call-outs for any charts or graphs. Hold the printout at arm's length. This is how your text will look on a 4' (1.2 meters)-wide screen at 10' (3 meters), on a 7.5' (2.3 meters)-wide screen at 20' (6.1 meters) and a 12' (3.7 meters)-wide screen at 30' (9.1 meters). If you cannot read the text easily, you should put less copy on your visuals or use larger typefaces.
- Design your visuals so that they are visible by the viewer in the last row.
- Nothing will ruin your presentation faster than misspelled words. Take the time to proofread and edit your work before your visuals become a permanent part of your presentation.
- Mixed case text is easier to read than text which is displayed in capital letters.
- Another important attribute of fonts is whether any particular face is serif or sans-serif. Serifs are small, usually horizontal cross strokes that are added to the end of a letter's main strokes. Because of their ability to coax the eye along the line of type, fonts with serifs are generally acknowledged to be more readable.



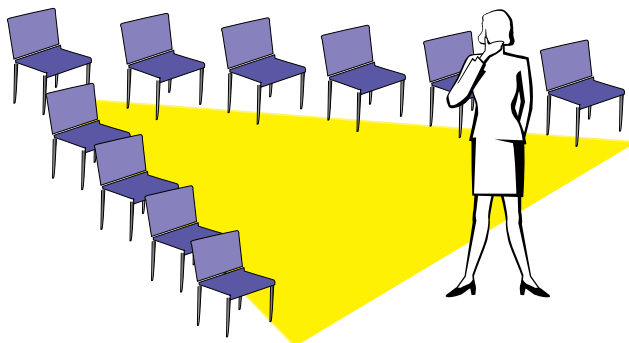
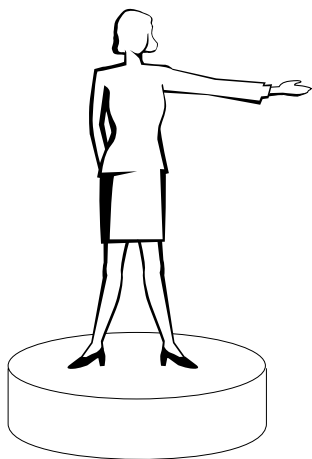
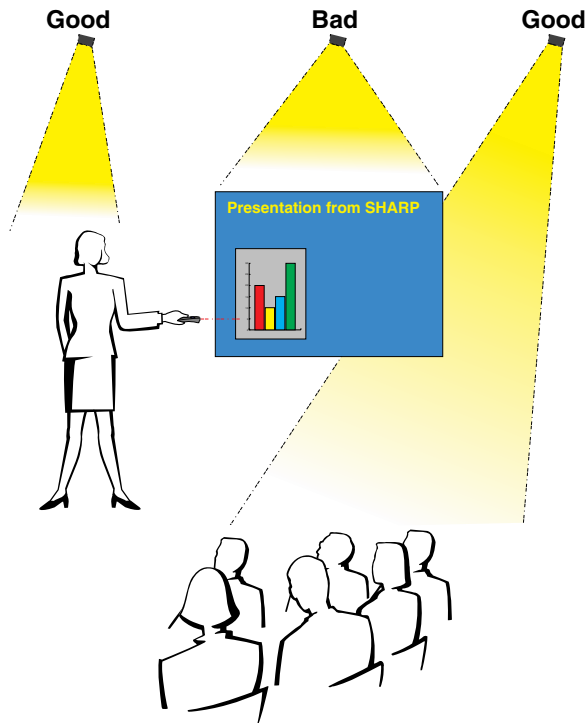

c. Set-Up

When giving a presentation, you need to set the stage both figuratively and literally for success. The way you set up a presentation room will have a great impact on the audience's perception of you and your message. By manipulating the placement and use of the following tools, you will improve the impact of your presentation.

Lighting—Good lighting is an important component of a successful presentation. You should strive to create an unequal distribution of light. An audience should always see as much of the presenter's face as possible, so most of the light should be focused on you. Because it is important for you to be able to read the audience's faces and body language, some light should be shed upon them. However, no light should shine on the screen.

Stage—When presenting on the same level surface that your audience is on, most people can only see the top one-third of your body. Therefore, it is recommended that when giving a presentation to an audience of 25 or more, you stand on a stage or platform. As more of your body is visible, the easier it is to communicate with an audience.

Podiums—The best presenters avoid podiums because they hide 75% of the body and restrict movement. However, many people feel more comfortable with a podium to hold their notes and hide their discomfort. If you must use a podium, angle it at 45 degrees to the audience so that you are not completely hidden.

Visuals—It is imperative that you make sure your visuals are large enough and projected far enough for the audience to see. Eight times the height of an image is the optimal viewing distance to read 24 point type. The bottom of a screen should be at least 6' (1.8 meters) above the floor.

Screen—The screen should always be in the center of the room so that all audience members can see it. Because people read from left to right, you should always stand to the audience's left when discussing visuals.

Seating—Arrange seating according to the dynamics of your presentation. If the presentation is more than half-a-day, use classroom style seating—a chair and a desk. If you would like to encourage audience interaction, use chevron seating, angling the chairs into a "V" shape. When you have a very small audience, a "U" shaped arrangement will increase interchange.





d. Rehearsing & Delivery

- The best time to rehearse is the day or evening before, not a couple of hours before, and the best place to rehearse is in the actual room. Rehearsing a speech in a small office is not the same as standing up in front of 100 people in a hotel ballroom or classroom.
- Due to varying processor speeds of computers, practice your slide transitions for proper timing.
- Whenever possible, set up your equipment well in advance to allow adequate time to resolve any unexpected issues such as lighting, power, seating and audio.
- Thoroughly check every piece of equipment you bring along. Make sure you have fresh batteries in your remote controls and laptop computer. Fully charge your computer's battery before the presentation and connect your AC adaptor for added safety.
- Make sure you are completely familiar with the control panel on your projector and remote controls.
- If you are using a microphone, check it out before hand and walk around to see where you might have problems with feedback. Avoid standing in these problem areas during your presentation.

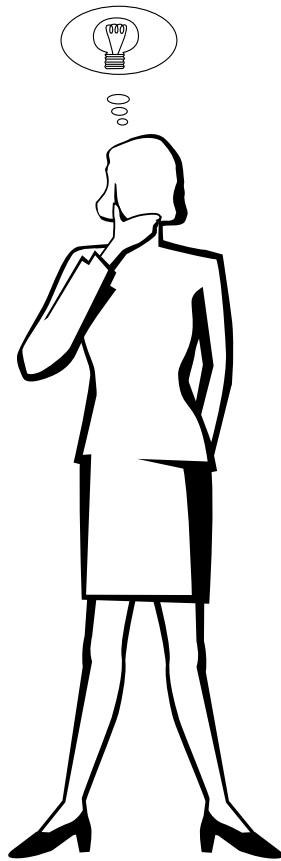

e. Presentation Tips

- Before beginning, visualize yourself delivering an outstanding presentation.
- Know your speech, memorizing at least the first three minutes of your presentation will allow you to focus on your rhythm and pacing.
- Speak to early arrivals to help you build a rapport with the audience and make you feel more comfortable.
- Do not be overly dependent on your visuals by reciting what your audience is already reading. Know your material well enough to be able to deliver the presentation with ease. Use your visuals to emphasize keypoints.
- Be sure to project your voice clearly and use eye contact to maintain audience attention.
- Do not wait until halfway through your presentation to get your point across. If you wait and try to create a “build-up”, you may lose some of your audience along the way.
- Keep your audience's attention. As most people only focus for 15 to 20 minutes during a one-hour presentation, it is important to recapture their attention periodically. Use phrases like, “This is critical to my point” or “This is absolutely fundamental” to remind them you are saying something they need to hear.





Glossary

Aspect ratio

Width and height ratio of an image. The normal aspect ratio of a computer and video image is 4 : 3. There are also wide images with an aspect ratio of 16 : 9 and 21 : 9.

Auto sync

Optimizes projected computer images by automatically adjusting certain characteristics.

Background

Initial setting image projected when no signal is being input.

Clock

Clock adjustment is used to adjust vertical noise when clock level is incorrect.

Compatibility

Ability to use with various image signal modes.

Composite sync

Signal combining horizontal and vertical sync pulses.

Digital keystone correction

Function to digitally correct a distorted image when the projector is set up at an angle.

Dot by dot

Mode that projects images in their native resolution.

Fit to screen

Function to adjust an image without keeping a native aspect ratio other than 4 : 3, and project it in a 4 : 3 ratio.

Freeze

Function to freeze a moving image.

GUI

Graphical User Interface. User interface with graphics that allow easier operation.

I/P conversion

Function to convert an image between "Interlaced" and "Progressive" scan displays.

Intelligent compression and expansion

High quality resizing of lower and higher resolution images to fit the projector's native resolution.

IrCOM

Function to transmit still images from a computer, hand-held PC or digital still camera via infrared communication for "Wireless Presentations".

IrDA

Standard protocol for wireless communication.

IrTran-P

Standard format (protocol) for transmission of images.

Magnification

Digitally zooms in on a portion of an image.

PDF

Portable Document Format. Documentation format used to transfer text and images from the CD-ROM.

Phase

Phase shift is a timing shift between isomorphic signals with the same resolution. When phase level is incorrect, the projected image typically displays horizontal flicker.

Presentation tools

Helpful tools used to emphasize keypoints throughout a presentation.

RS-232C

Function to control the projector from the computer by using the RS-232C ports on the projector and computer.

Startup image

The image displayed when the projector is turned on.

Status function

Displays the settings of each adjustment item.

Sync

Synchronizes the resolution and phase shift of two signals. When receiving an image with a resolution different from that of the computer, the projected image may be distorted.

Sync on green

Video signal mode of a computer which overlaps horizontal and vertical sync signal to green color signal pin.

Wireless mouse

Function to operate the mouse control of the computer with the supplied remote control.

XGA resolution

The resolution with 1,024 × 768 pixels that uses the signal of an IBM/AT compatible (DOS/V) computer.





Index

A

AC socket	11
ADJUSTMENT buttons	23
Air filter	46
Aspect ratio	36
Audio adjustments	28
AUDIO INPUT 1 terminal	11
AUDIO INPUT 2 terminal	11
AUDIO INPUT terminals	13
AUDIO OUTPUT terminal	14
Automatic power shutoff function	38
Auto sync adjustment	30
AUTO SYNC button	29

B

Background	41
BACKLIGHT button	22
BLACK SCREEN button	37
BNC-RCA adaptors	13

C

Carrying handle	50
Ceiling-mount	20
Ceiling + Rear	42
Clock	29
Computer audio cable	11
Computer cable	11
Cooling fan (Exhaust vent)	5
Cooling fan (Intake vent)	7

D

Digital keystone correction	3
DIN-D-sub RS-232C cable	14
Dot by dot	36

E

ENLARGE button	34
ENTER button	23
Extra air filter	10

F

15 pin/BNC switch	11
Fit to screen	36
Foot releases	19
FREEZE button	33

G

GAMMA button	35
GUI (Graphical User Interface)	23

I

INPUT 1 port	11
INPUT 1 terminals	12
INPUT 2 port	11
INPUT button	17
Intelligent compression and expansion	3
I/P conversion	39
IrCOM	25
IrCOM button	25
IrCOM sensors	25
IrDA	59
IrTran-P	59

K

Kensington Security Standard connector	49
--	----

L

LAMP REPLACEMENT indicator	47
LASER POINTER button	22
Laser pointer window	5
LEFT-CLICK button	22
LENS button	19
Lens cap	50

M

MENU button	23
MOUSE/ADJUSTMENT switch	21
MOUSE buttons	22
Mouse control cable for IBM PS/2	15
Mouse control cable for Mac	15
Mouse control serial cable	15
MUTE button	17

O

On-screen display language	26
OUTPUT port	7

P

PDF	6
Phase	29
Picture adjustments	27
POWER buttons	17
Power cord	11
POWER indicator	16
Presentation tools	43

R

Rear projection	20
Remote control	21
Remote control sensor	21
Remote control signal transmitter	8
Remote mouse receiver	21
RESIZE button	36
RIGHT-CLICK button	22
RS-232C port	14

S

Sharp Advanced Presentation Software (SAPS)	25
Speakers	7
Startup image	41
Status function	44
S-VIDEO INPUT terminal	13
Sync	30
Sync on green	51

T

TEMPERATURE WARNING indicator	47
TOOLS button	43

U

UNDO button	19
-------------	----

V

VIDEO INPUT terminal	13
VOLUME buttons	17

W

Wired remote control input	22
WIRED REMOTE control input terminal	22
Wireless mouse	21

X

XGA resolution	3
----------------	---



SHARP CORPORATION

OSAKA, JAPAN